

The poster features a light blue background with a fine halftone dot pattern. Numerous realistic water droplets of various sizes are scattered across the surface, some with highlights and shadows. A thin, light blue curved line sweeps across the middle of the page, passing behind the word 'WATER'.

37TH ANNUAL MISSISSIPPI

WATER

RESOURCES CONFERENCE

APRIL 24-25, 2007

JACKSON, MS

Conference Sponsors:

Mississippi Department of Environmental Quality

Mississippi Public Service Commission

Mississippi Water Resources Association

Mississippi Water Resources Research Institute

U.S. Geological Survey

TABLE OF CONTENTS

Opening Plenary Session	1
Poster Session.....	3
Session A: Delta Groundwater.....	46
Session B: Modeling	80
Session C: Invasives	92
Session D: Agriculture	114
Session E: Sedimentation	138
Session F: Wastewater and Water Treatment.....	162
Session G: Surface Water Quality	176
Session H: Flooding and Water Supply.....	200
Closing Plenary Session.....	224

PROGRAM

Tuesday, April 24

7:30 a.m.	Continental Breakfast	Madison Hall
8:30 a.m.	Overview of Water Issues: Now and In the Future George Hopper , Moderator Director, Mississippi Water Resources Research Institute	Diplomat I and II
8:45 a.m.	Brandon Presley Mayor of Nettleton	
9:05 a.m.	Colonel Alfred Bleakley Deputy Commander U.S. Army Corps of Engineers - Mississippi Valley District	
9:25 a.m.	Ted Leininger Supervisory Research Plant Pathologist USDA Forest Service	
9:45 a.m.	Trudy Fisher Executive Director Mississippi Department of Environmental Quality	
10:05 a.m.	Bill Walker Executive Director Mississippi Department of Marine Resources	
10:30 a.m.	Break	Regency Hallway
10:45 a.m.	Poster Session	Regency Hallway
	Ardeshir Adeli and Dennis E. Rowe , Broiler litter management affects on soluble constituents in leachate and runoff from bermudagrass forage based system	
	Trey Cooke , Bee Lake watershed restoration project	
	Charlie Cooper, Sammie Smith Jr., Henry Folmar, Sam Testa III , Pesticide presence and concentrations In surface waters of selected lakes and reservoirs (<500 acres) of Mississippi	
	Shelby Fortune and Todd Tietjen , Comparison of automated versus manual monitoring of levels of dissolved oxygen in aquaculture ponds	
	Cyle Keith, H. Borazjani, S.V.Diehl, M.L. Prewitt, Y.Su, Fengxiang Han and B.S. Baldwin , Aquatic phytoremediation of CCA and copper contaminated water	
	Claudio A. Spadotto, Marcus B. Matallo, Marco A.F. Gomes, Luiz C. Luchini, Antonio L. Cerdeira , Effects of attenuation and dispersion factors on tetracycline leaching stimulation	
	Jeremy Murdoch, Kim Collins and Timothy J. Schauwecker , Conservation planning integrating site assessment and hydrologic modeling at the Mississippi State University Dairy Unit, Sessums, MS	
	M. Lynn Prewitt, Celina Phelps, Mike Cox, Rick Evans and Susan Diehl , Bacterial source tracking of a watershed impacted by cattle pastures	
	John J. Read, Geoffrey E. Brink, Steve L. McGowen and Jim G. Thomas , Effect of Swine Effluent Application Rate and Timing on Nitrogen Utilization and Residual Soil Nitrogen in Common Bermudagrass	
	Peter E. Schweizer , Conservation planning for fish assemblages based on land cover distribution	
	John Storm , Real-time pier scour monitoring on the Pascagoula River at Interstate 10	

PROGRAM

Tuesday, April 24 (continued)

11:45 a.m.	<p>Luncheon Bo Robinson, Invocation and Introduction Northern District Public Service Commissioner</p> <p>Leonard Bentz, Keynote Speaker Southern District Public Service Commissioner</p>	Madison Hall
1:00 p.m.	Session A: Delta Groundwater - Jamie Crawford , Moderator (Concurrent Session)	Diplomat I
1:00 p.m.	Shane Powers , Agricultural water use in the Mississippi Delta	
1:20 p.m.	Claire E. Rose , Determining Potential for Direct Recharge in the Mississippi River Alluvial Aquifer Using Soil Core Analyses, Washington County, Northwestern Mississippi	
1:40 p.m.	Mark Stiles , Changes in water volume in the Mississippi River Valley Alluvial Aquifer in Northwest Mississippi	
2:00 p.m.	Break	Regency Hallway
2:15 p.m.	Session A: Delta Groundwater - Jamie Crawford , Moderator (Concurrent Session continued)	Diplomat I
2:15 p.m.	Patrick C. Mills , Potential for infiltration through the fine-grained surficial deposits of the Bogue Phalia Watershed, Mississippi	
2:35 p.m.	Charlotte Bryant Byrd , Mississippi River Valley Alluvial Aquifer geology of the central Delta (East Central Sunflower County and West Central Leflore County)	
2:55 p.m.	James E. Starnes , Mississippi River floodplain "Delta" - Bluff margin alluvial fan complexes	
1:00 p.m.	Session B: Modeling - Greg Jackson , Moderator (Concurrent Session)	Diplomat II
1:00 p.m.	J. N. Diaz , Evaluation of HSPF streamflow uncertainty bounds due to potential evapotranspiration bias and parameter variability	
1:20 p.m.	Peter E. Schweizer , Spatial distribution of land cover and their influences on watershed condition	
1:40 p.m.	Peter Ampim , Pesticide runoff from bermudagrass: Effects of plot size and mowing height	
2:00 p.m.	Break	Regency Hallway
2:15 p.m.	Session B: Modeling - Greg Jackson , Moderator (Concurrent Session continued)	Diplomat II
2:15 p.m.	William H. McAnally , Modeling Mobile Bay sediments and pollutants with new technologies	
2:35 p.m.	Zhiyong Duan , Integration of impact factors of gas-liquid transfer rate	
2:55 p.m.	Richard A. Rebich , Activities of the U.S. Geological Survey related to total nitrogen and total phosphorus trends and modeling in surface waters of the Lower Mississippi and Texas-Gulf River basins	
3:15 p.m.	Break	Regency Hallway
3:30 p.m.	Session C: Invasives - Jake Schaefer , Moderator (Concurrent Session)	Diplomat I
3:30 p.m.	John D. Madsen , Ecologically-based invasive aquatic plant management: Using life history analysis to manage aquatic weeds	
3:50 p.m.	Joshua C. Cheshier , Common reed: <i>Phragmites Australis</i> (CAV.) Trin. Ex Steud: Life history in the Mobile River Delta, Alabama	
4:10 p.m.	Ryan M. Wersal , Littoral zone plant communities in the Ross Barnett Reservoir, MS	
4:30 p.m.	Wilfredo Robles , The invasive status of giant salvinia and hydrilla in Mississippi	

PROGRAM

3:30 p.m.	Session D: Agriculture - Dean Pennington , Moderator (Concurrent Session)	Diplomat II
3:30 p.m.	John P Brooks , Antibiotic resistant and pathogenic bacteria associated with rain runoff following land application of poultry litter	
3:50 p.m.	Antonio L. Cerdeira , Agriculture and ground water quality in a sugarcane area in São Paulo State, Brazil	
4:10 p.m.	Bill Branch , Irrigation Water Conservation Through Use of Level basins in Louisiana	
Wednesday, April 25		
7:00 a.m.	Continental Breakfast	Regency Hallway
8:00 a.m.	Session E: Sedimentation - Dave Johnson , Moderator (Concurrent Session)	Diplomat I
8:00 a.m.	Michael S. Runner , Sediment monitoring of Mill Creek, Rankin County, Mississippi	
8:20 a.m.	William G. Walker , Pre-settlement sediment accumulation rates in lake-wetland systems in the Mississippi Delta region using the ¹⁴ C activity of bulk sediment fractions	
8:40 a.m.	Chioma G. Nzeh , Effects of sitation on some aquatic animals communities in a man-made lake in Ilorin, Nigeria	
9:00 a.m.	Humberto Avila , Experimental design analysis applied to factors related to migration of sediment out of a stormwater catchbasin sump	
8:00 a.m.	Session F: Wastewater and Water Treatment - Dallas Baker , Moderator (Concurrent Session)	Diplomat II
8:00 a.m.	Mary Love M. Tagert , Water quality impacts of failing septic systems in a coastal area	
8:20 a.m.	Richard H. Coupe , Occurrence and persistence of pesticides, pharmaceutical compounds, and other organic contaminants in a conventional drinking-water treatment plant	
8:40 a.m.	Jejal Reddy Bathi , Standardization of thermal desorption GC/MS analysis for polycyclic aromatic hydrocarbons and comparison of recoveries for two different sample matrices	
9:00 a.m.	Afrachanna D. Butler , Phytomanaging firing range soils using <i>Cyperus esculentus</i>	
9:20 a.m.	Break	Regency Hallway
9:40 a.m.	Session G: Surface Water Quality - LaDon Swann , Moderator (Concurrent Session)	Diplomat I
9:40 a.m.	Todd Tietjen , Water quality and floristic quality assessments of the Big Sunflower River following streamflow augmentation using groundwater	
10:00 a.m.	Brianna Zuber , Fluctuating asymmetry and condition in fishes exposed to varying levels of environmental stressors	
10:20 a.m.	Mansour Zakikhani , Water quality modeling in support of the Mississippi Sound Coastal improvement program	
10:40 a.m.	Matthew Hicks , Mississippi benthic macroinvertebrate tolerance values for use in surface water quality assessment	
9:40 a.m.	Session H: Flooding and Water Supply - Mike Davis , Moderator (Concurrent Session)	Diplomat II
9:40 a.m.	K. Van Wilson, Jr. , Mapping Hurricane Katrina peak storm surge in Alabama, Mississippi, and Louisiana	
10:00 a.m.	David B. Reed , National Weather Service expansion of hydrologic services in Mississippi	
10:20 a.m.	Philip Songa , Supply and demand: The effects of development on the hydrology of Lake Victoria	
10:40 a.m.	David T. Dockery , The geology of ground water in Mississippi revised	

PROGRAM



Wednesday, April 25

11:00 a.m.	Closing Plenary Session Mickey Plunkett , Moderator Director, USGS - Mississippi Water Science Center	Diplomat I and II
11:10 a.m.	Joy Foy Director, Asset Development Division Mississippi Development Authority	
11:40 a.m.	LaDon Swann Director Mississippi-Alabama Sea Grant Consortium	
12:20 p.m.	Luncheon and Awards Ceremony Mike Davis , Invocation and Introduction Pearl River Basin Development District The Honorable Jamie Franks , Keynote Speaker (invited) Mississippi House of Representatives	Madison Hall



OPENING PLENARY SESSION

Honorable Brandon Presley

Mayor
Nittleton, MS

Colonel Alfred Bleakley

Deputy Commander
U.S. Army Corps of Engineers, Mississippi Valley District

Dr. Ted Leininger

Supervisory Research Plant Pathologist
USDA Forest Service, Center for Bottomland Hardwood Research

Ms. Trudy Fisher

Executive Director
Mississippi Department of Environmental Quality

Mr. Bill Walker

Executive Director
Mississippi Department of Marine Resources

NOTES



POSTER SESSION

Broiler litter management affects on soluble constituents in leachate and runoff from bermudagrass forage based system

Ardeshire Adeli and Dennis E. Rowe
ARS-USDA, Waste Management and Forage Research Unit

Bee Lake watershed restoration project

Trey Cooke
Delta Wildlife, Inc.

Pesticide presence and concentration in surface waters of selected lakes and reservoirs (>500 acres) of Mississippi

Charlie Cooper, Sammie Smith Jr., Henry Folmar, Sam Testa III
USDA ARS National Sedimentation Laboratory, Mississippi Department of Environmental Quality

Comparison of automated versus manual monitoring of levels of dissolved oxygen in aquaculture ponds

Shelby Fortune and Todd Tietjen
College of Forest Resources, Mississippi State University

Aquatic phytoremediation of CCA and copper contaminated water

Cyle Keith, Hamid Borazjani, Susan Diehl, Lynn Prewitt, Y. Su, Fengxiang Han, and B.S. Baldwin
College of Forest Resources, Mississippi State University

Effects of attenuation and dispersion factors on tebuthiuron leaching simulation

Claudio A. Spadotto, Marcus B. Matallo, Marco A.F. Gomes, Luiz C. Luchini, Antonio L. Cerdeira
Brazilian Department of Agriculture, Agricultural Research Service, EMBRAPA/Environment, Jaguariúna, SP, Brazil

Conservation planning integrating site assessment and hydrologic modeling at the Mississippi State University Dairy Unit, Sessums, MS

Jeremy Murdoch, Kim Collins and Timothy J. Schauwecker
Department of Landscape Architecture, Mississippi State University

Bacterial source tracking of a watershed impacted by cattle pastures

M. Lynn Prewitt, Celina Phelps, Mike Cox, Rick Evans and Susan Diehl
Department of Forest Products, Mississippi State University

Effect of Swine Effluent Application Rate and Timing on Nitrogen Utilization and Residual Soil Nitrogen in Common Bermudagrass

John J. Read, Geoffrey E. Brink, Steve L. McGowen and Jim G. Thomas
USDA-ARS, Waste Management and Forage Research Unit

Conservation planning for fish assemblages based on land cover distribution

Peter E. Schweizer
Environmental and Plant Biology, Ohio University

Real-time pier scour monitoring on the Pascagoula River at Interstate 10

John Storm
U.S. Geological Survey, Mississippi Water Science Center

POSTER SESSION

Effects of Broiler litter Management on Runoff N and P in Bermudagrass Forage Based System

Ardeshir Adeli, John P. Brooks, Dennis E. Rowe and D.M. Miles

ARS-USDA

Waste Management and Forage Research Unit

810 Highway 12 East

Mississippi State, MS 39762

Corresponding Author: aadeli@msa-msstate.ars.usda.gov

ABSTRACT

Management of broiler litter to provide nutrients for crop growth has generally been based on crop N requirements. Because broiler litter has a lower N/P ratio than harvested crops, N-based broiler management often oversupplies the crop-soil system with P, which can be lost into the environment. This study was conducted in 2005 and 2006 at Mississippi State University Plant science center at South farm to investigate the effects of nitrogen vs. phosphorus based broiler litter application on bermudagrass [*Cynodon dactylon* (L.)] dry matter yield, N and P uptake, leaching and runoff nutrients and soil P accumulation. Treatments included N-based broiler litter rate, combination of P based broiler litter with supplemental N, chemical fertilizer N and P at the recommended rate for comparison purposes, and the control with no nutrient inputs. Nitrate concentrations in leachate collected from chemical fertilizer and N based broiler litter treatments averaged 26 mg NO₃-N L⁻¹ and no difference was obtained between treatments. Regardless of treatments, total P loss in the leachate was in very small quantities indicating minimal downward movement of P. However, P losses in runoff from N based broiler litter was significantly greater than P based treatment. In the top 15 cm of soil in plots receiving the N-based treatment, soil test P increased by 64% from 20 to 57 mg kg⁻¹. Nitrogen- and P-based broiler litter application did not differ in supplying nutrients for crop growth. However, the N-based broiler litter led to greater accumulation of soil test P in the top surface 15 cm of soil as compared to P-based broiler litter. Surface soil P accumulation has implications for increased risk of off-field P movement which may contribute to eutrophication of water bodies.

Keywords: Water quality, Broiler litter management and planning, Nitrogen and Phosphorus transport, Forage based system

Introduction

Commercial broiler production in Mississippi generate large quantities of a broiler litter (manure and bedding materials), which is applied to nearby pastures or croplands. The generated broiler litter contains multiple nutrients, including N, P, K, Ca, Mg, and micronutrients (Edwards and Daniel, 1992). Of these nutrients, N and P comprise the most agronomically and environmentally important proportions of broiler litter. Broiler litter has been used for fertilization of bermudagrass [*Cynodon dactylon* (L.)] (Brink et al., 2002) and perennial tall fescue (Kingery et al., 1994). Broiler litter has a lower N/P ratio than harvested crops. The requirement of forage grasses for N relative to P (range of 5:1

relative to 10:1) greatly exceeds the concentration of N relative to P in broiler litter (approximately 2:1; (Edwards et al., 1992). Thus, application of broiler litter based on crop N needs generally often oversupplies the crop-soil system with P. Since P accumulates in the surface soil, broiler litter application to pasture and hay fields increases the potential for P loss in runoff to surface waters and may cause water quality degradation (Sims, 1995). Land application of broiler litter has come under closer scrutiny by state and federal agencies due to heightened environmental concerns. Strategies for the best use of the litter need to be investigated. This study was conducted in 2005 and 2006 to determine investigate if crop yield, nutrient removal and runoff losses of N and P are

different between N-based and P-based broiler litter applications to bermudagrass forage based system.

Materials and Methods

The experiment was conducted in Mississippi Agriculture and Forestry Experiment Station (MAFES) at the Plant Science Center in south farm. The soil was classified as Mariate silt loam (fine-loamy, siliceous, active, thermic Fluvaquentic Eutrudepts) with initial characteristics shown in table 1. The soil particle distribution in the 0- to 15 cm depth was 15% sand, 60% silt, and 25% clay. The soil physical and chemical parameters measured on samples collected before the initiation of the experiment are presented in table 1.

Parameter	
pH	5.2
Total C, g kg ⁻¹	14.4
Total N, g kg ⁻¹	1.11
Mehlich 3, mg kg ⁻¹	36.8
Water soluble P, mg kg ⁻¹	3.4
NO ₃ -N, mg kg ⁻¹	17.9
NH ₄ -N, mg kg ⁻¹	4.8
Bulk density	1.31

Parameter	2005	2006
pH	7.4	7.3
Total C, g kg ⁻¹	320	318
Total N, g kg ⁻¹	26.8	34.9
Total P, g kg ⁻¹	15.8	18.9
K, g kg ⁻¹	23.8	41.8
Mg, g kg ⁻¹	9.7	17.9
Zn, mg kg ⁻¹	238	639
Cu, mg kg ⁻¹	410	574

The experimental design was a randomized complete block including 4 treatments replicated three times with a plot dimension of 14 ft by 7 ft. There were a total of 12 plots.

The total precipitation falling in the growing season (through May to October) was 85 cm in 2005 and 39 cm in 2006.

Broiler litter was applied to established bermudagrass at the rate included: (i) control, receiving no fertilizer or broiler litter; (ii) inorganic fertilizer N as ammonium nitrate at the rate of 250 kg N ha⁻¹ recommended by Mississippi Soil Testing for bermudagrass, (iii) N-based broiler litter, applied to meet crop N uptake requirement; and (iv) P-based broiler litter, applied to supply the crop P requirement, with additional supplemental N as ammonium nitrate fertilizer. Both broiler litter and chemical fertilizer were applied by hand-broadcasting with no incorporation into the soil.

Broiler litter was collected from the floor of a broiler house. Broiler litter was surface-applied one time annually to the forages at the time of spring regrowth in May. Broiler litter samples were taken, air-dried, ground to pass 2 mm sieve, and analyzed for total N using an automated dry-combustion analyzer. Total P in broiler litter was determined by dry-ashing procedure, filtering, and analyzing using an inductively coupled argon plasma spectrophotometry (ICP).

Forage was harvested four times, typically in mid-June, end of July, mid-September and late October. One swath (total of 24.5 ft²) was harvested from each plot using a commercial rotary mower set at a height of 5 cm. Harvested forage was weighed, and subsamples were dried at 65° C for 72 h in a forced-air oven. Dried plant material was ground to pass 2 mm sieve. Nitrogen content of forage was determined using an automated dry-combustion analyzer. Total P content was determined by dry-ashing plant samples. Yield and tissue N and P concentration were used to calculate N and P uptake.

Following each rain event, 1/10 or 1/100 portion of runoff volume generated from each plot were collected using an installed runoff collector. Runoff samples were filtered and analyzed using a Lachat system for measuring total inorganic N and dissolved P. Kjeldahl procedure was used to measure total N in the runoff samples (Bremner, 1996). Total P and micro nutrient in runoff samples were determined using an acid digestion method (Kuo, 1996).

Five cores (2.5 cm in diameter) were taken and composited for each plot and depth in the field, mixed thoroughly,

Effects of Broiler litter Management on Runoff N and P in Bermudagrass Forage Based System
Adeli, et al

and a representative sample was taken for analysis. Soil samples were taken at the end of growing season each year to a depth of 30 cm and divided into depth increments of 0 to 15 and 15 to 30cm. Soil samples were air-dried and ground to pass 2 mm sieve and extracted using Mehlich 3 (Mehlich, 1984) solution, filtered and analyzed for extractable P using an ICP.

Statistical analysis were performed in SAS (SAS Institute, 1996) using the General Linear Models procedure. Means were separated by LSD at a 0.05 level of significance.

Results and Discussions

Dry matter yield

Dry matter yield was greater in 2005 than in 2006 due to the very dry condition during the bermudagrass growing season in 2006 (Fig. 1). In 2005, bermudagrass dry matter yields for all treatments were greater than the control. Dry matter yields for the N-based and P-based broiler litter applications were similar to those for the chemical fertilizer treatment, indicating both systems can provide added nutrients to bermudagrass, similar to fertilizer treatment. In 2006, both N-based and P-based, with additional N fertilizer, broiler litter application had similar dry matter yield, suggesting both broiler litter management systems were similar in nutrient availability at the rates used in this study. However, bermudagrass in both systems had greater dry matter yield as compared to chemical fertilizer (Table 3).

Total N and P uptake

The effects of broiler litter management on bermudagrass total N uptake followed the same pattern as dry matter production and the values were greater in 2005 than in 2006 (Table 3). In 2005, differences among treatments were greater for total N uptake than for dry matter production and N-based treatment had the greatest effect on total N uptake. However, in 2006 total N uptake followed exactly the same pattern as dry matter production. This is probably because of enough rain during the growing season in 2005 which resulted in luxury consumption of N for N-based treatment. No significant difference in total N uptake was obtained between P-based broiler litter application and chemical fertilizer in 2005.

Similar to N uptake, bermudagrass total P uptake was greater in 2005 than those in 2006 (Table 3). In both 2005 and 2006, total P uptake was significantly different among treatments and the greatest effect was in P-based broiler litter application. In the favorable bermudagrass growing conditions of 2005, total P uptake exceeded the expected 30 kg P ha⁻¹ for both N-based and P-based broiler litter applications (Table 3). The initial soil P level in this study is considered high (Table 1). Higher soil P level normally results in less adsorption of the applied P by the soil. Phosphorus-based broiler litter application significantly resulted in the greatest P uptake by bermudagrass. This is possibly due to this reason that smaller amounts of P was applied with P-based than with N-based broiler litter application. Phosphorus use efficiency is usually greater for lower P application (Eghball and Sander, 1989).

Runoff N and P concentrations

Runoff sample nitrate N concentration varied widely among the treatment both in 2005 and 2006. Averaged across the runoff events, nitrate concentration from control plots receiving no N input were 1.78 and 1.8 mg L⁻¹ in 2005 and 2006, respectively (Table 4). However, treatments receiving N in inorganic fertilizer or broiler litter had 14.9 and 9.1 mg L⁻¹ in 2005 and 2.32 and 7.5 mg L⁻¹ in 2006, respectively. No significant difference in N uptake was obtained between N-based and P-based treatments in both

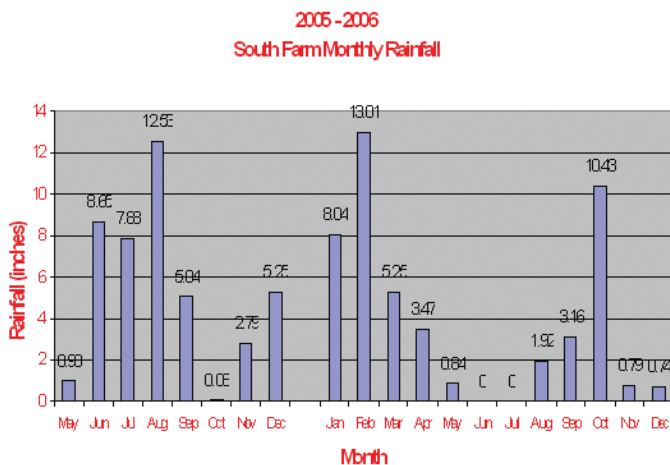

Figure 1. Rainfall distributions by year. Amount of rainfall (inch) for each rainfall event is presented by a vertical bar.

Table 3. Effects of broiler litter management system on bermudagrass yield and N and P uptake.

Treatment	2005			2006		
	Dry matter	N uptake	P uptake	Dry matter	N uptake	P uptake
	Mg ha ⁻¹	kg ha ⁻¹		Mg ha ⁻¹	kg ha ⁻¹	
Control	4.5 b*	76.9 c	13.8 d	2.1 c	37.1 c	6.1 d
Fertilizer	10.6 a	258.2 b	28.4 c	5.6 b	156.4 b	14.1 c
N-based	12.2 a	351.8 a	33.9 b	9.8 a	218.3 a	25.0 b
P-based	11.3 a	313.0 ab	39.9 a	8.8 a	216.2 a	35.0 a

* Values followed by the same letter were not significantly different at the 0.05 probability level.

2005 and 2006. The lower runoff N concentration from P-based broiler litter could possibly be related to N use efficiency which is usually greater for lower N loading rate for P-based broiler litter application. Phosphorus based broiler litter application significantly decreased runoff nitrate as compared to N-based broiler litter treatments in both 2005 and 2006. Dissolved P in runoff was significantly lower in the P-based than the N-based broiler litter application both in 2005 and 2006. In both years, no significant difference in P concentration in runoff was obtained between P-based broiler litter and chemical fertilizer N (Table 4).

Conclusions

Annual broiler litter application based on N or P requirements of bermudagrass resulted in similar dry matter yields and N removal. No significant difference in N removal was obtained between N-based and P-based broiler applications. However, P and N use efficiency was greater for P-based

than N-based resulted in lowering runoff nitrate N and P in both 2005 and 2006, indicating application of broiler litter based on crop P requirements with supplemental fertilizer N agronomically and environmentally sound.

References

- Bremner, J.M. 1996. Nitrogen-total. Pp1085-1122. In D.L. Sparks et al. (ed). Methods of Soil Analysis. Part 3, Chemical Methods. Soil Science Society of America
- Edwards, D.R., T.C. Daniel, and O. Marbun. 1992. Determination of best timing for poultry waste disposal: A modeling approach. Water Res. Bull. 28:487-494.
- Kuo, S. 1996. Phosphorus. In Methods of Soil Analysis, Part 3, Agronomy No, 5. Bigham, J.M. (ed.) Soil Science Society of America, ASA. Madison, Wisconsin, Pp. 869-874.

Table 4. Effects of broiler litter management system on runoff N and P concentration.

Treatment	2005 runoff				2006 runoff			
	Concentration		Total quantity		Concentration		Total quantity	
	NO ₃ -N	P	NO ₃ -N	P	NO ₃ -N	P	NO ₃ -N	P
	mg l ⁻¹		kg ha ⁻¹		mg l ⁻¹		kg ha ⁻¹	
Control	1.78	1.04	7.12	5.2	1.8	1.06	6.3	4.1
Fertilizer	14.9	2.03	61.09	10.4	2.28	2.11	8.21	8.2
N-based	9.1	7.72	36.1	30.8	7.46	5.24	26.11	20.4
P-based	2.9	2.61	11.31	10.4	2.32	1.98	8.35	7.5
LSD _(0.05)	6.2	1.33	4.3	2.4	1.45	1.12	3.11	3.65

Effects of Broiler litter Management on Runoff N and P in Bermudagrass Forage Based System Adeli, et al

Mehlich, A. 1984. Mehlich 3 soil extractant: A modification of Mehlich 2 extractant. *Commun. Soil Sci. Plant Anal.* 15:1409-1416.

Brink, G.E., D. E. Rowe and K. R. Sistani . 2002. Broiler Litter Application Effects on Yield and Nutrient Uptake of 'Alicia' Bermudagrass. *Agron. J* 94:911-916 (2002)

Kingery, W.L., C.W. Wood, D.P. Delaney, J.C. Williams, G.L. Mullins. 1994. Impact of long-term land application of broiler litter on environmentally related soil properties. *J. Environ. Qual.* 23:139-147.

SAS Institute. 1996. SAS user's guide. Statistics. Version 5. SAS Inst., Cary, NC.

Eghball, B., and D.H. Sander. 1989. Band spacing effects of dual-placed nitrogen and phosphorus fertilizers on corn. *Agro. J.* 81:178-184.

Sims, J.T. 1995. Characteristics of animal waste and waste amended soils: An over-view of the agricultural and environmental issues, P. 1-14. In K. Steele (ed.) *animal waste and land-water interface*. CRC Press, Boca Raton, FL.

Wood, B.H., C.W. Wood, K.H. Yooq, and D.P. Delaney. 1996. Nutrient accumulation and nitrate leaching under broiler litter amended corn fields. *Commun. Soil Sci. Plant Anal.* 27:2875-2894.

POSTER SESSION

Bee Lake Watershed Restoration Project

Trey Cooke
Executive Director
Delta Wildlife, Inc.
P.O. Box 276
Stoneville, MS 38776
662-686-3370
E-mail: trey@deltawildlife.org

ABSTRACT

Bee Lake, a historical Ohio River oxbow, is located in Holmes County, Mississippi. The 11,870-acre watershed is dominated by row crop agriculture and feeds the 1,400-acre lake during most of the year. Annual backwater flooding also reaches Bee Lake as the Yazoo River floods into Tchula Lake and then backs into Bee Lake. Standard agricultural practices and the highly erosive nature of the soils found in the watershed have caused significant sediment loading in Bee Lake. Since intensive agriculture began in the watershed, the historical lake depth has been reduced by 50%.

Listed on the 1996 Mississippi 303(d) list of impaired waters, TMDLs for nutrients, organic enrichment, low dissolved oxygen, pesticides, and sediment were developed for Bee Lake. Because of these impairments and the lake's popularity among fishermen, the Mississippi Department of Environmental Quality - Yazoo Basin Team prioritized Bee Lake for future restoration efforts.

In 2005, the Bee Lake Watershed Implementation Team (WIT) was formed. This team included 42 individuals, of which 27 were natural resource professionals and 15 were landowners from the watershed. This team identified all natural resource and related concerns in the watershed. In order of priority, the identified concerns included (1) Sediment and Turbidity, (2) Lake Level and Water Supply, (3) Noxious Aquatic Vegetation, (4) Organic Enrichment, (5) Future Development, (6) Fisheries Management, and (7) Lake Access. After all concerns were identified, solutions and funding mechanisms were proposed.

The efforts of the Bee Lake Watershed Team were used to develop a comprehensive Bee Lake Watershed Implementation Plan (WIP). The plan was designed to address all concerns identified by the WIT. The plan included implementation plans for each item, funding sources, and a timeline for restoration. Major components of the plan included BMP installation and maintenance to address priority concerns, water quality monitoring, and educational outreach.

Implementation of structural measures began in the spring of 2006. By 2007, all aspects of the WIP will be implemented. The goal of implementation will be to reduce sediment loading by 35%-67% per year, reduce nitrogen loading by 70% per year, reduce phosphorous loading by 33% per year, and reduce DDT and Toxaphene loading by 33% per year. If these goals are met, Bee Lake will be removed from the 303(d) list of impaired waters and the DDT/Toxaphene fish advisories will be lifted. Other related items that will also be addressed include: rebuilding the weir to stabilize lake levels for increased water storage capacity for surface water irrigation, control of noxious aquatic weeds in the lake, establishment of a homeowners association to control development, improve fisheries through lake specific creels and slot limits, and the addition of a new boat ramp to increase lake access for the public.

Keywords: Management and Planning, Nonpoint Source Pollution, Sediments, Water Quality, Water Supply

POSTER SESSION

Pesticide Presence and Concentrations In Surface Waters of Selected Lakes and Reservoirs (<500 acres) of Mississippi

Charlie Cooper, Sammie Smith Jr., Henry Folmar, Sam Testa III
USDA Agricultural Research Service National Sedimentation Laboratory
Water Quality & Ecology Research Unit
PO Box 1157
598 McElroy Drive
Oxford, MS 38655 USA
662-232-2900
Email: ccooper@msa-oxford.ars.usda.gov

ABSTRACT

Surface water from 46 small (100 to < 500 acres) lakes and reservoirs located throughout Mississippi was sampled to test for presence and concentration levels of eighteen current-use or residual pesticides or their breakdown products. Each lake was sampled an average of five times from November 4, 2004 to October 6, 2005. In all, 3,988 analyses were performed, and the overall detection rate was 13%. The most frequently detected compound was Σ DDT which exhibited an 85% detection rate. Fortunately, all concentrations were below 0.25 $\mu\text{g/L}$. Dieldrin, which had an approximate 34% detection rate, had no detections above 0.05 $\mu\text{g/L}$. The next three most commonly detected compounds were breakdown products of DDT and fipronil. The herbicide 2,4-D was commonly detected, and 13% of tested samples were quantifiable above 1.0 $\mu\text{g/L}$, with the highest observed concentration being 2.75 $\mu\text{g/L}$. Atrazine, the seventh most often detected compound, had the highest observed single concentration (14.47 $\mu\text{g/L}$) of all compounds tested and had an average concentration of 0.125 $\mu\text{g/L}$. Metolachlor was the only other compound detected at a concentration greater than 1.0 $\mu\text{g/L}$. Pendimethalin was the only compound not detected in any samples at any of the lakes. Butler Lake and Long Creek Reservoir both had 13 compounds detected. Only two pesticides were detected at Davis Lake, Filter Lake, and Flatland Lake. Watershed land-use revealed few specifics because of the scale of resolution (all mixed cover watersheds). Detection of specific pesticides indicated that urban and agricultural land uses both made substantial contributions to surface water contamination.

Keywords: Water Quality, Surface Water, Nonpoint Source Pollution

Introduction

As humankind increasingly relies on pesticides for production of agricultural products and control of disease and pests, the potential for environmental contamination by these necessary chemicals is a constant concern. Use of pesticides in the United States can be traced to the 1860s. Concern about persistence and negative effects on vertebrates resulted in the banning of organochlorine insecticides in 1972. It also resulted in significant increases in our understanding of detrimental effects of all pesticides, particularly as quantified by toxicity testing (Blus 1995).

The United States has roughly 80,000 substantial reservoirs, many of which are public access water bodies. Mississippi has a large number of natural lakes, created by river meander, in addition to thousands of small to large constructed reservoirs. These waterbodies are used for a variety of purposes, including commercial, sports and subsistence fishing, and also swimming and recreation. Previously (Cooper et al. 2004), we reported results of a water quality survey of pesticides in larger (>500 acres) public access lakes and reservoirs located in Mississippi. Herein, we present findings of a similar study of smaller (<500 acre surface area) lakes and reservoirs.

Methods

Field Methods and Study Sites

Lake sampling was done from boat by Mississippi Department of Environmental Quality (MDEQ) personnel at 46 lakes throughout Mississippi. Surface water grab samples were collected in specially cleaned, solvent-rinsed glass jars according to United States Environmental Protection Agency (U.S. EPA) recommendations. Samples were immediately placed on ice and transported to the United States Department of Agriculture's National Sedimentation Laboratory in Oxford, MS where they were stabilized, and processed.

Sampling of the 46 lakes resulted in 225 collections. Samples were collected between November 04, 2004, and October 06, 2005, with a single collection period from each lake during winter (November-December 2004), a single collection period during spring (March-April 2005), two collection periods during summer (June-July 2005), and two collection periods during fall (August-October 2005). Some lakes were not sampled every period due to inaccessibility or safety issues.

Lake surface areas ranged from 102 to 459 acres, with a mean area of 215 acres. Lake types included 29 reservoirs, 15 oxbows, and two natural lowland lakes (Flatland Lake and Lake Gillirad). A summary of watershed land use / land cover characteristics for sampled lakes during this study is given in Table A (data for Horseshoe Lake were unavailable). Locations for sampled lakes within the state are shown in Figure 1.

Pesticide Analyses

Gas chromatography (GC) was used for all analyses except for 2,4-D. Lake samples for GC analyses were extracted within one hour of receipt by adding 1.0 g KCl and 100 mL pesticide grade ethyl acetate (EtOAc), shaking vigorously by hand for about one minute, and stored at 4 °C

(usually <24 h) for pesticide analyses via GC using a modified method similar to that of Bennett et al. (2000) and Smith and Cooper (2004). Briefly, sample preparation involved partitioning in a separatory funnel, and discarding the water phase. The EtOAc phase was dried over anhydrous sodium sulfate and concentrated by rotary evaporation to near dryness. The extract was taken up in about five mL pesticide-grade hexane, cleaned up by silica gel column chromatography, and concentrated to 1.0 mL under dry nitrogen for GC analysis. Mean extraction efficiencies, based on fortified samples, were >90% for all pesticides.

Two Hewlett Packard (now Agilent) model 6890 gas

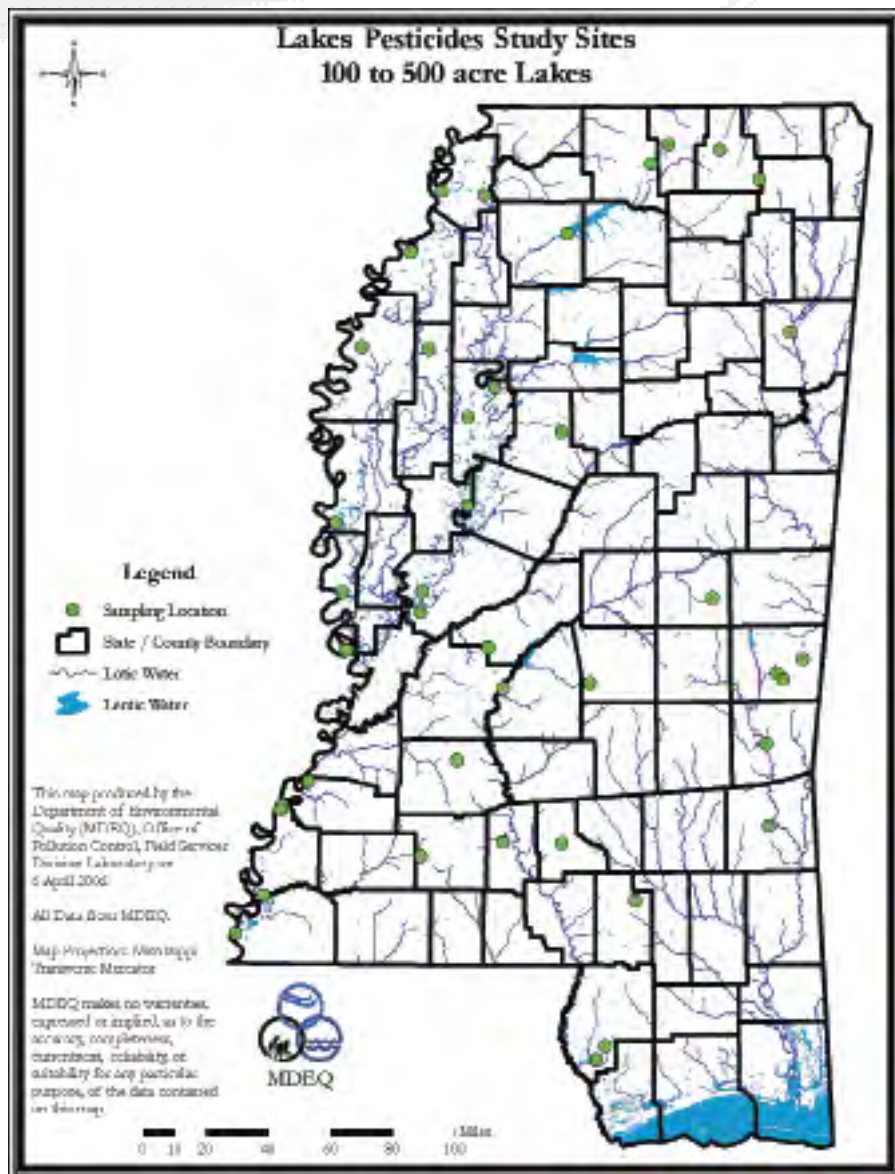

Figure 1. Location for sampled lakes within the state.

Pesticide Presence and Concentrations In Surface Waters of Selected Lakes and Reservoirs (<500 acres) of Mississippi

Cooper, et al

Table A. Summary of watershed land use/land cover characteristics for lakes that were sampled during this study (except Horseshoe Lake, unavailable).

	Mean	Median	Maximum
Urban Acres	50	0	708
Forest Acres	2513	822	24940
Agriculture Acres	2052	83	43081
Pasture Acres	1444	978	11806
Disturbed Acres	10	0	144
Water Acres	321	258	1888
Wetland Acres	984	369	11224
Total Acres	7275	3186	51262
Urban %	1%	0%	6%
Forest %	35%	46%	81%
Agriculture %	14%	2%	87%
Pasture %	23%	25%	57%
Disturbed %	0%	0%	2%
Water %	10%	6%	36%
Wetland %	17%	2%	94%

chromatographs each equipped with dual HP 7683 ALS autoinjectors, dual split-splitless inlets, dual capillary columns, and a HP Kayak XA Chemstation were used to conduct all pesticide analyses (Smith and Cooper 2004). One HP 6890 was equipped with two HP micro electron capture detectors (μ ECDs) and the other 6890 with one HP μ ECD, one HP nitrogen phosphorus detector (NPD), and one HP 5973 mass selective detector (MSD).

The main analytical column was a HP 5MS capillary column (30 m x 0.25 mm i. d. x 0.25 μ m film thickness). Column oven temperatures were as follows: initial at 85 °C for one minute, ramp at 25 °C min⁻¹ to 190 °C, hold at 190 °C for 25 minutes, ramp at 25 °C to 230 °C, and hold for 30 minutes. The carrier gas was UHP helium at 28 cm sec⁻¹ average velocity with the inlet pressure at 8.64 psi and inlet temperature at 250 °C. The μ ECD temperature was 325 °C with a constant make up gas flow of 40 cc min⁻¹ UHP

nitrogen. The autoinjector was set at 1.0- μ L injection volume in fast mode. Under these GC conditions, all 17 pesticides were analyzed in a single run of 61.80 min. When deemed necessary, pesticide residues were confirmed with a HP 1MS capillary column (30 m x 0.25 mm i.d. x 0.25- μ m film thickness) and/or with the MSD. The MSD was used only when there was a question as to the identity of a particular pesticide. Online HP Pesticide and NIST search libraries were used when needed.

Analyses for 2,4-D were made according to EPA Method 4015 screening by immunoassay using the 2,4-D RaPID Assay® enzyme linked immunosorbent assay (ELISA) products and instructions from Strategic Diagnostics Inc. A known quantity of the sample is added to an enzyme conjugate followed by paramagnetic particles with antibodies specific to chlorophenoxy herbicides attached. Both the 2,4-D which may be in the sample and the enzyme conjugate (labeled 2,4-D enzyme) compete for antibody binding sites on the magnetic particles. After allowing the reaction to occur, a magnetic field is applied to hold the paramagnetic particles with 2,4-D and labeled 2,4-D analog bound to the antibodies on the particles, in proportion to their original concentration in the tube. Unbound reagents are decanted. The 2,4-D is then detected by adding hydrogen peroxide and the chromogen, 3,3',5,5'-tetramethylbenzidine, that catalyzes the conversion of the substrate and chromogen mixture to a colored product. The color developed is inversely proportional to the concentration of 2,4-D in the sample and is measured using a photometer at a wavelength of 450 nm. Sample results are compared to results from known standards containing 2,4-D in the range from 1.0 to 50.0 μ g/L.

The concentration level of detection and level of quantification for 2,4-D using the ELISA technique are much higher than those methods for other pesticides using the GC techniques. Additionally, availability of analysis materials for 2,4-D prohibited testing on all samples. Thus, a subset of 163 samples was analyzed. Consequently, data reduction and interpretation for 2,4-D analysis results may differ from that of other pesticides discussed in this paper. A summary of analyte method limits is given in Table B.

Table B. Targeted pesticides, levels of detection (LOD) and limits of quantitation (LOQ) (ng/L). Insecticides in bold.

Pesticide	LOD	LOQ
Alachlor	0.5	5
Atrazine	1.0	10
Bifenthrin	0.1	1
Chlorfenapyr	0.5	5
Chlorpyrifos	0.1	1
Cyanazine	0.5	5
p,p'-DDD	0.1	10
p,p'-DDE	0.1	1
p,p'-DDT	1.0	10
Dieldrin	0.1	1
Fipronil	0.1	1
Fipronil sulfone	0.1	1
λ-Cyhalothrin	0.1	1
Methyl parathion	1.0	10
Metolachlor	1.0	10
Pendimethalin	0.5	5
Trifluralin	0.1	1
2,4-D	*0.70 µg/L	*1 µg/L

*Note: Levels are given in µg/L for 2,4-D, all other units are in ng/L.

Results and Discussion

Occurrence

During a one year period we collected 225 surface water samples in 46 natural lakes or constructed reservoirs. We tested each of those samples for 18 pesticide analytes (current use, residual organochlorine or their breakdown products) which resulted in 3,988 individual analyses. Pesticides were detected in 13% of the nearly 4,000 individual tests. At least one pesticide was detected in 88% of the 225 surface water samples. Of those 225 surface water "grab" samples, the 26 which had no detections were all collected during the summer (June 2005) period of low rainfall. Frequency of occurrence of individual compounds was dominated

by DDT which was followed by its metabolites (Table C). DDT occurred in 85% of all samples analyzed, while DDE (27%) and DDD (15%) ranked third and fifth in pesticide occurrence. The second most commonly observed compound was Dieldrin, with a 34% frequency of occurrence. Fipronil Sulfone, the degradation product of fipronil, the fourth most frequently encountered compound, was detected in 20% of samples. The herbicides with the greatest number of occurrences were 2,4-D (13%) and Atrazine (11%). They ranked sixth and seventh, respectively, in frequency of occurrence.

Occurrence patterns were generally driven by isolated events associated with individual watersheds or more pervasive trends caused by seasonal rainfall patterns and pesticide applications. There was essentially no runoff or contamination during the early summer dry period as shown by only seven pesticide detections of a possible 612. Instances of isolated elevated pesticide concentrations were observed from lakes on single dates. Late in the summer, heightened concentrations of Atrazine, Chlorpyrifos, Dieldrin, Fipronil Sulfone, and DDT were recorded from Lake Henry near Greenwood, MS after thunderstorm-like rainfall. Another example of elevated pesticide concentrations occurred in Long Creek Reservoir near Meridian, MS in July, 2005, where Trifluralin, Methyl Parathion, Alachlor, Chlorpyrifos, Cyanazine, Dieldrin, Fipronil, Chlorfenapyr, Bifenthrin and DDT were associated with large amounts of precipitation over a several day period. Butler Lake near Natchez produced similar results after localized thunderstorm activity. Other observed instances of spiked pesticide concentrations on single dates from single lakes could not definitively be associated with increased rainfall using National Oceanic and Atmospheric Administration weather station information.

Although pesticides were detected in 88% of samples, the majority of detections were associated with Σ DDT or Dieldrin. Since these legacy insecticides have been banned for decades in the United States, time for the insecticides to dissipate beyond detection is the only course of action for general environmental improvement. When we excluded Σ DDT and Dieldrin from the occurrence data, 140 samples (62%) had no detections. Fifty-one additional samples had a single detection, and there were 19 that only contained two detec-

POSTER SESSION

Pesticide Presence and Concentrations In Surface Waters of Selected Lakes and Reservoirs (<500 acres) of Mississippi

Cooper, et al

tions. These accounted for 82% of all surface water samples. Pesticides were detected during all seasons. When data were sorted by lake, \sum DDT was found in all lakes. When it was excluded, no lake had pesticide detections year-round. While greatest concentrations were detected in oxbow lakes, comparisons of detections in reservoirs and natural lakes revealed no major differences in seasonal occurrence.

Pesticide Concentrations

While pesticide occurrence per individual grab samples was high, overall concentrations were very low (Table C). However, of the 51 samples that contained only one pesticide detection, 16 had values greater than 0.1 $\mu\text{g/L}$,

possibly indicating that their presence was associated with an individual event. The overall mean concentration of herbicides was 0.02 $\mu\text{g/L}$. Four herbicides occurred at concentrations above 0.1 $\mu\text{g/L}$. Of 25 detections, Atrazine, the predominant corn herbicide in the United States, had 11 concentrations above 0.1 $\mu\text{g/L}$ and also had the greatest maximum herbicide concentration (14.47 $\mu\text{g/L}$). 2,4-D, the most widely used residential herbicide in the United States, occurred in 13% of samples and had a maximum concentration of 2.75 $\mu\text{g/L}$. While Metolachlor occurred in only two percent of the samples (mean concentration=0.01 $\mu\text{g/L}$), its maximum concentration was 1.95 $\mu\text{g/L}$.

The overall mean concentration for insecticides was

Table C. Summary of pesticide occurrence and mean concentration observed for all samples collected during this study. Occurrence is given as number of detections above quantitation limit (Table B) divided by total possible detections (n=225). Concentration is given as $\mu\text{g/L}$. Insecticides in bold.

Compound	Occurrence	Concentration	Standard Error	Maximum
pp'-DDT	85%	0.0635	0.0025	0.2441
Dieldrin	34%	0.0016	0.0003	0.0311
pp'-DDE	27%	0.0013	0.0002	0.0223
Fipronil sulfone	20%	0.0027	0.0005	0.0637
pp'-DDD	15%	0.0013	0.0004	0.0703
2,4-D*	13%	0.1883	0.0780	2.7500
Atrazine	11%	0.1253	0.0697	14.4655
Chlorpyrifos	8%	0.0205	0.0050	0.5726
λ-Cyhalothrin	6%	0.0028	0.0010	0.1967
Chlorfenapyr	5%	0.0003	0.0001	0.0247
Trifluralin	4%	0.0005	0.0002	0.0375
Bifenthrin	4%	0.0029	0.0018	0.3803
Methyl parathion	4%	0.0038	0.0014	0.1490
Fipronil	2%	0.0005	0.0002	0.0289
Metolachlor	2%	0.0098	0.0087	1.9510
Cyanazine	1%	0.0004	0.0003	0.0599
Alachlor	1%	0.0040	0.0036	0.8065
Pendimethalin	0%	0.0000	0.0000	0.0000

* Note: The mean concentration value shown for 2,4-D was calculated including non-quantifiable observations using a value of 0.00, while occurrence here is based only on quantifiable readings. See text for more information.

only 0.01 µg/L. Maximum concentrations are listed in Table C. Thirty-seven \sum DDT concentrations were in excess of 0.1 µg/L, and the maximum \sum DDT concentration was 0.33 µg/L. Dieldrin, while commonly encountered, had no detections of 0.1 µg/L or greater in the 76 samplings where it was present. However, chlorpyrifos, lambda-Cyhalothrin, Bifenthrin, and Methyl Parathion all had at least one observed concentration above 0.1 µg/L.

Pesticide application and seasonal rainfall patterns created predictable concentration trends. For the six herbicides tested by gas chromatography, highest overall concentrations were found in the summer (0.04 µg/L), lowest in fall (0.01 µg/L), and intermediate and similar concentrations observed in spring (0.02 µg/L) and winter samples (0.02 µg/L). Only five lakes had these herbicides with concentrations of over 1.0 µg/L. Dump Lake (3.65 µg/L, April 2005), an oxbow lake in Yazoo County; Lake Henry (14.47 µg/L, June 2005), an oxbow lake in Leflore County; Lake Mary Crawford (4.65 µg/L, November 2004), a reservoir in Lawrence County; and Little Eagle Lake (1.43 µg/L, July 2005), an oxbow lake in Humphreys County, had high concentrations of Atrazine during one visit. The only other herbicide found above 1.0 µg/L was Metolachlor, observed in Long Lake, an oxbow lake in Sunflower County, at a concentration of 1.95 µg/L in July 2005. Immunoassay tests for the herbicide 2,4-D showed that it had highest concentrations in spring (1.31 µg/L) and summer (1.18 µg/L), and lower values for fall (0.40 µg/L) and winter (0.35 µg/L) seasons. Since the immunoassay test limit of quantification for 2,4-D was 1.0 µg/L, all 21 measurements of 2,4-D were above 1.0 µg/L. However, 24 analyses indicated non-detection, yielding an average concentration of 0.1883 µg/L. Quantification of lower value concentrations of 2,4-D using a different method would provide a more precise actual average concentration of 2,4-D in Mississippi lakes and reservoirs.

Pesticide detections above 0.1 µg/L were spread across seasons. Of the 225 lake samples, 15 samples in winter, seven samples in spring, 42 samples in summer, and 12 samples in fall reached 0.1 µg/L. Summer detections were not directly comparable to the other seasons because lakes were sampled twice in summer, but \sum DDT was present in 32

of the 42 summer surface water samples. Chlorpyrifos exhibited an unexplained seasonal phenomenon; it contaminated 35% of winter samples, and all winter detections exceeded 0.1 µg/L. A few other pesticides showed tendencies toward seasonal trends. Conversely, the only period of the study in which \sum DDT was totally absent from lake samples was during the low rainfall part of the summer sampling.

Pesticides and Land Use Patterns

We delineated major categories of land use (Table A) for each of the 46 sampled watersheds. No watershed had only a single land use. When different principal watershed land uses were compared, the number of occurrences by pesticides followed the trend from agriculture to forest to pasture and wetlands. Unfortunately, urban land use and land cover percent for any watershed were so small as to be highly overshadowed by other uses. Only eleven watersheds had a quantifiable urban percentage.

We tabulated the number of occurrences of individual pesticides for each land use category. Insecticides \sum DDT and Dieldrin dominated instances of occurrence in all land use categories. The weed killer 2,4-D was detected in 20 lakes, making it the most widely detected herbicide. In order of occurrence after \sum DDT and Dieldrin, Fipronil Sulfone was followed by 2,4-D and Atrazine in all land use categories. Chlorpyrifos and lambda-Cyhalothrin were the next most prevalent compounds observed in all categories except urban, where Fipronil and Trifluralin were the next most detected pesticides. Thus \sum DDT, 2,4-D, Atrazine, and Fipronil Sulfone were common regardless of dominant land use. \sum DDT, the most commonly detected residual insecticide, appears to be ubiquitous as other studies have indicated (Cooper et al. 2004). Low concentrations (mean = 0.05 µg/L) of \sum DDT were present in most samples (85% occurrence). Use of DDT was banned in 1972; use actually peaked in 1968, but its application was so widespread from 1945 to 1972 that it is likely found in every watershed in the state of Mississippi. Fipronil occurred in 2.2% of the 225 samples, and its residual in 20% of samples. It is registered for insect control in corn, indoor pests and turf grass, and for termite control (Termidor®). It is also the active ingredient in tick and flea

POSTER SESSION

Pesticide Presence and Concentrations In Surface Waters of Selected Lakes and Reservoirs (<500 acres) of Mississippi

Cooper, et al

collars (Frontline Plus®).

In our Mississippi study, 2,4-D was detected in 43% (including trace detections) of all sites and was followed by atrazine contamination at 36% of all sites. Several pesticides used extensively in agriculture were infrequently detected. These included the herbicides Metolachlor, Cyanazine, Trifluralin, Alachlor and the insecticide Chlorpyrifos which is also used in non-agricultural settings. Nationwide, 2,4-D has historically been the most used active ingredient in non-agricultural herbicide markets with between seven and nine million pounds used in the home and garden sector and between 17 and 20 million pounds used in the industry-commercial-government sector each year (U.S. EPA 2001). Like 2,4-D, Atrazine, the most commonly used agricultural herbicide in Mississippi other than perhaps glyphosate, was found frequently in small water bodies, but it occurred less frequently than in larger lakes and reservoirs (Cooper et al. 2004). Like within larger lakes in Mississippi, common pesticides were associated with all land uses, not just agriculture (Cooper et al. 2004).

Cooper (1990) found agricultural soils to be a continuing source of DDT in Mississippi. Coupe et al. (2000) studied pesticide occurrence in air and rain from an urban site and an agricultural site in Mississippi. Every sample collected from either site had detections of multiple pesticides although total concentration was five to 10 times higher at the agricultural site. There were six pesticides in current use that were found in more than 20% of the samples taken. Of those six, all but one were insecticides. The lone herbicide was atrazine.

For nationwide comparison, U.S. Geological Survey (U.S.G.S.) analyzed patterns of pesticide use across the United States as part of the National Water Quality Assessment (NAWQA) program (Gilliom et al., 1999) and confirmed that concentrations of herbicides and insecticides in agricultural streams of the nation closely followed use patterns. Urban streams had the highest insecticide concentrations; seven of 11 urban streams had total insecticide concentrations in the upper 25% of all streams sampled, although some agricultural streams in irrigated agricultural areas of the western United States also had high levels. The most frequent-

ly detected compounds in agricultural areas were the herbicides atrazine, metolachlor, cyanazine, and alachlor which were ranked in the top five in national herbicide use for agriculture. The most heavily used herbicides also accounted for most of the detections in rivers and major aquifers and many of the detections in urban streams and shallow groundwater (Gilliom et al. 1999). In our study, when watersheds were separated by land use, bearing in mind that urban use was never a significant portion of catchment area, all uses showed a high degree of similarity in compounds detected.

In summary, we found pesticides were measurable in small lakes and reservoirs throughout the state of Mississippi. Banned organochlorine insecticides dominated frequency of occurrence regardless of land use or season. When these residual insecticides are excluded from compound detections, incidence of detection for all 225 surface water samples was reduced from 88% to 62%. The detection rate for all 3,988 individual analyses was 13%. Occurrence was dominated by DDT, Dieldrin, Fipronil Sulfone, 2,4-D, and Atrazine. While greater concentrations were detected in oxbow lakes, comparisons of detections in reservoirs and natural lakes revealed no major differences in occurrence, nor were there any specific compound differences when chemicals were sorted by land use. Occurrence patterns were driven by either isolated rainfall events associated with individual water bodies or larger trends caused by seasonal rainfall patterns and pesticide applications. Four herbicides had concentrations above 0.1 µg/L; of the 46 lakes in the study, only five lakes had herbicide concentrations that exceeded 1.0 µg/L. Five insecticides exceeded 0.1 µg/L in 31 waterbodies.

References

- Bennett, E.R., M.T. Moore, C.M. Cooper, and S. Smith, Jr. 2000. Method for the simultaneous extraction and analysis of two current-use pesticides, atrazine and λ-cyhalothrin, in sediment and aquatic plants. *Bulletin of Environmental Contamination and Toxicology* 64:825-833.
- Blus, L.J. 1995. *Organochlorine Pesticides*. IN: Hoffman, D.J.; B.A. Rattner; G.A. Burton, Jr; J. Cairns, Jr. (eds). *Handbook of Ecotoxicology*. pp. 275-300.

Cooper, C.M. 1990. Persistent organochlorines and current use insecticide concentration in major watershed components of Moon Lake, Mississippi, USA. *Archiv Für Hydrobiologie* 121:103-113.

Cooper, C. M., S. Smith, Jr., and H. Folmar. 2004. Pesticide concentrations in surface waters of Mississippi lakes and reservoirs. *Proceedings of Mississippi Water Resources Annual Meeting, Jackson, MS.*, p. 62-71.

Coupe, R.H., M.A. Manning, W.T. Foreman, D.A. Goolsby, and M.S. Majewski. 2000. Occurrence of pesticides in rain and air in urban and agricultural areas of Mississippi, April-September 1995. *The Science of the Total Environment* 248:227-240.

Gilliom, R.J., J.E. Barbash, D.W. Kolpin, and S.J. Larson. 1999. Testing Water Quality for Pesticide Pollution. *Environmental Science and Technology* 33(7):164 A-169 A.

Smith, Jr., S. and C.M. Cooper. 2004. Pesticides in shallow groundwater and lake water in the Mississippi Delta MSEA. Chapter 7. pages 91-103. IN: *Water Quality Assessments in the Mississippi Delta, Regional Solutions, National Scope.* Mary Nett, Martin Locke and Dean Pennington, (Eds.). ACS Symposium Series 877. American Chemical Society. Chicago, IL. Oxford University Press.

U.S. EPA. 2001. About pesticides. 1998-1999 pesticide market estimates: usage. Section: 3.1-

3.10. URL address: http://www.epa.gov/oppbead1/pestsales/99pestsales/usage1999_4.html.

Acknowledgements

Recognition is given to MDEQ staff who braved the elements to obtain these samples, including; Emily Cotton, Ann-Marie Denman, Barbara Viskup, D. Barnes, Al Gibson, Jenny Ulmer, Alice Dossett, Otis Clark, Charles Thompson, Will Green, Mike Beiser and Chip Bray. Sample routing and delivery was facilitated by (MDEQ) Alisa Liggins, Amanda White, Michelle Burns, and (NSL) Charlie Bryant and Terry Welch. Lisa Brooks meticulously handled sample extraction and cataloguing at the NSL. Brad Segrest created the lake location map.

USDA is an equal opportunity provider and employer. The United States Department of Agriculture (USDA) prohibits discrimination in all its programs and activities on the basis of race, color, national origin, gender, religion, age, disability, political beliefs, sexual orientation, and marital or family status. (Not all prohibited bases apply to all programs.)

Persons with disabilities who require alternative means for communication of program information (Braille, large print, audio tape, etc.) should contact USDA's TARGET Center at 202-720-2600 (voice and TDD). To file a complaint of discrimination, write USDA, Director, Office of Civil Rights, Room 326-W, Whitten Building, 14th and Independence Avenue, SW, Washington, DC 20250-9410 or call 202-720-5964 (voice or TDD). USDA is an equal opportunity provider and employer.

"Mention of trade names or commercial products in this publication is solely for the purpose of providing specific information and does not imply recommendation or endorsement by the U.S. Department of Agriculture."

POSTER SESSION

Comparison of Automated versus Manual Monitoring of Levels of Dissolved Oxygen in Aquaculture Ponds

Shelby Fortune and Todd Tietjen
Department of Wildlife and Fisheries
College of Forest Resources
Mississippi State University
Box 9690
Mississippi State, MS 39762
662-312-7051
Email: sef39@msstate.edu

ABSTRACT

Automated water quality monitoring systems can be used to help maintain optimal levels of dissolved oxygen (DO) in aquaculture systems by continuously monitoring oxygen concentrations and immediately turning on aerators to supplement oxygen if a critical limit is reached. This study compares differences in water quality maintenance under operation schemes using manual and automated water quality monitoring of DO concentrations. A commercial automated monitoring system will be used to monitor the DO concentrations in the aquaculture ponds on the Mississippi State University campus. Data collected by this system will be used to document the amount of time that DO concentrations would have fallen below threshold levels under a manual monitoring operation scheme. Mississippi State University aquaculture facility employees will be interviewed to determine how often DO measurements are needed and how often they can be collected from the entire 75 pond complex. Data collected by the automated monitors will be used to simulate manual data collection by using the automated measurements and the sampling timeline for manual collection. Using this information will determine the amount of time that DO concentrations in the pond would have been below acceptable levels without automated monitoring. Automated monitoring systems should detect low DO concentrations more quickly than manual monitoring which will promote fish growth and facilitate the management and planning of aquaculture operations, and therefore increase overall production for catfish farms and other aquaculture industries across the country.

Keywords: Methods, Water Quality, Surface Water, Economics

Introduction

Commercial catfish farming has developed into one of the most important aquaculture industries in the United States. Growth of the industry has occurred over the last twenty years because of the expansion of facilities and area used for catfish farming. This economic success has largely been a result of low production costs and enhanced control of water quality. Maintenance of adequate levels of dissolved oxygen (DO) is critical in maintaining a functional aquaculture environment and oxygen concentration is a primary determinant of water quality (Colt, 2006). It is an important variable to consider because sufficient DO is es-

sential to the health and survival of most aquatic organisms (Wetzel & Likens, 1991; Wetzel, 2001). Fish production in pond culture systems is often limited by DO concentrations (Drapcho and Brune 2000) and supplying adequate DO, either biologically or mechanically, is an essential management practice for pond aquaculture. Oxygen supply must be sufficient to fulfill overall respiratory demand for pond biota (microbes, algae, insects, etc.) as well as for cultured fish (Hargreaves & Tucker, 2003).

Manually measuring and monitoring DO concentrations in an aquaculture setting can become a laborious task with the high number of ponds or sampling locations, seasonal

temperature changes, weather conditions, and possible depletion of oxygen during the evening. Automated oxygen monitoring systems have the potential to reduce labor and energy costs, decrease disease and mortality rates among aquaculture species, and increase production yields through constant monitoring, management, and enhancement of water quality in aquaculture systems. Measurement and control units, water quality sensors, and communication devices for relaying data and recording pond conditions combine to create a more productive and efficient aquaculture operation (Campbell Scientific, Inc., 2005).

Study Area

Research was conducted at Mississippi State University's MAFES Aquaculture Research Unit on the Mississippi State University campus during two separate time periods; September 21, 2006 to October 18, 2006 and October 23, 2006 to November 17, 2006. There are 87 ponds on South Farm ranging from 0.04 to 0.10 hectares. Each pond has a water inflow pipe and an out flow standpipe to maintain water depth and water retention time. Of the 87 ponds, 75 were equipped with automated oxygen monitors and were used to conduct the outlined measurements.

Methods

Compare/Contrast Manual vs. Automatic Techniques

An Integrator Aquasystems™ automated monitoring system was used to monitor the DO concentrations and temperature in the aquaculture ponds. The Integrator monitors were calibrated according to manufacturer's instructions as needed. Dissolved oxygen concentrations were collected daily with a handheld YSI DO probe and compared to simultaneous automated measurements in order to verify calibration. To calculate the differences between maintenance of DO concentrations by manual and automated oxygen monitors, the detection time of low oxygen concentrations under manual operation was estimated using continuous oxygen measurements from the automated monitoring system and the schedule of manual sampling (described below). The amount of time that DO concentrations would have fallen to and remained below threshold levels before being identified

under a manual monitoring scheme was then summed across all ponds and tallied as the total number of ponds receiving additional aeration.

Oxygen deficits were calculated as the time between automated measurements initiated aeration and the scheduled time manual measurements taken by Mississippi State University aquaculture facility employees would have detected low oxygen conditions. Conceptually this is shown in Figure 1. This figure shows anticipated oxygen concentrations under the 3 different management schemes; automated management, manual monitoring and without aeration. When no aeration is applied to the ponds the diurnal shift in oxygen concentrations is extremely high as concentrations drop to 0 mg O₂ L⁻¹ during the night. Under an automated sampling scheme with DO triggers set at 3 mg O₂ L⁻¹ concentrations are prevented from falling below this critical level. Manual DO monitoring produces a similar result overall to the automated scheme but there are significant lag periods around dawn and dusk where the timing of manual sampling fails to detect falling DO concentrations as quickly as the automated system.

Aquaculture facility employees were interviewed to determine how often DO measurements were needed and how often they can be collected manually from the entire 87 pond complex. Employees take DO samples daily at approximately 6 AM, 2 PM, 10 PM, 2 AM, and 4 AM; collection of these samples require an hour each time. From this a model sampling schedule representative of the manual process was established staggering the samples in a systematic way to capture the time required to move between ponds. The Integrator systems were set to turn aerators on if DO reached 3 mg/L. Data that the automated monitors collected was used to simulate manual data collection by using the automated measurements and the sampling timeline for manual collection. For example if the Integrator system turned aeration on at 9 PM while oxygen would not have been checked manually until 10 PM, then this would be recorded as 60 minutes of additional aeration for this single pond. The number of additional aeration minutes was then summed across all 75 ponds. This information determined the amount of time that DO concentrations in the ponds would have been below

Comparison of Automated versus Manual Monitoring of Levels of Dissolved Oxygen in Aquaculture Ponds

Fortune, et al

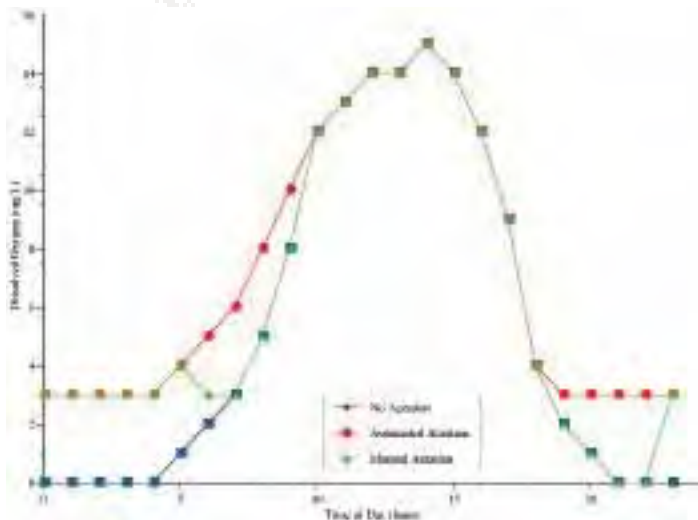

Figure 1. Conceptual representation of dissolved oxygen concentrations in aquaculture ponds under different oxygen management schemes. The blue diamonds represent oxygen concentrations if there is no management of oxygen, the red squares represent oxygen concentrations with automated control of aerators and a trigger of 3 mg O₂ L⁻¹. The green triangles represent oxygen concentrations with manual monitoring and aerator control with a trigger of 3 mg O₂ L⁻¹ and manual sampling at 2 AM, 4 AM, 6 AM, 2 PM, and 10 PM.

acceptable levels without automated monitoring. Additionally the percentage of the 75 ponds that received additional aeration under the automated scheme was calculated to assess how widespread the under-aeration was across all ponds.

Results and Conclusions

Based on the comparison of automated measurements and estimates of manual measurements, oxygen deficits would have occurred at some point in 28 ponds over the time period that was considered using only a manual operation scheme. This totaled 8,805 minutes more aeration time than would have occurred had the automated monitors not been controlling aeration within the ponds. Of those 8,805 total minutes, 1,830 minutes (~21%) came from the later time period studied which included a period with cooler temperatures. Oxygen concentrations are not usually checked as often, if at all, during these cooling periods as it is assumed that with lower temperatures DO concentrations will not be

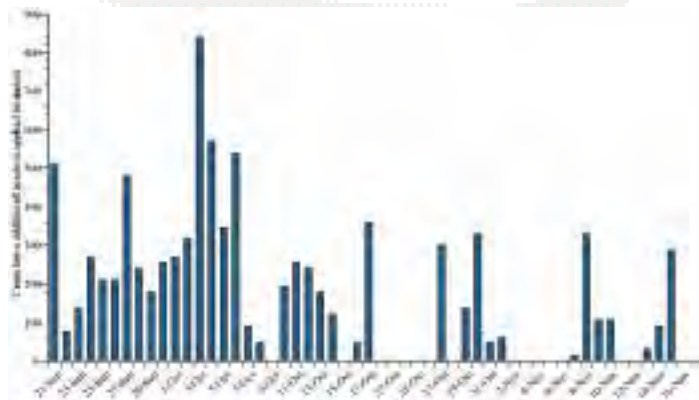

Figure 2. Cumulative additional aeration time across all 75 ponds managed under the automated aeration scheme. This data is analogous to the a summation of the amount of time that ponds would have been below the critical 3 mg O₂ L⁻¹ threshold under a manual management scheme.

as critical or variable. This late season aeration might not have occurred under manual operation potentially causing fish stress or death.

Figure 2 illustrates the amount of time that additional aeration would have been used each day using automated monitoring techniques. When combined with Figure 3 which illustrates the percentage of ponds receiving extra aeration each day over the 28 ponds found to have oxygen deficits a comprehensive picture of the benefits of automated oxygen management become apparent. During the early sampling period as many as 22 of the ponds received additional aeration on any given day with 300 to over 800 minutes of cumulative additional aeration. While this data does not allow us to make precise assessments of the timing of these additional aeration events, it is likely that they are occurring during the critical periods at dawn or dusk. Following the 6AM manual sampling scheme aeration would be shut off if DO concentrations were 3 mg O₂ L⁻¹ or higher. This discounts

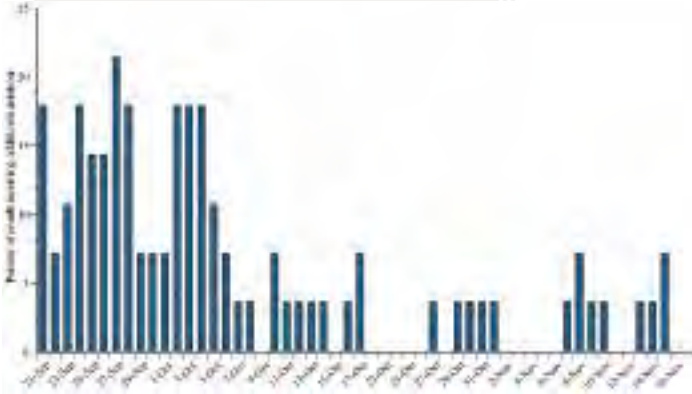

Figure 3. Percentage of the 75 total ponds that received additional aeration under the automated management scheme. This data is analogous to the percentage of ponds that would have suffered low oxygen conditions under a manual management scheme.

the possibility of cloud cover slowing the increase in light and related increases in oxygen production by photosynthesis, which would result in DO levels declining through the morning. At dusk DO concentrations are similarly subject to unanticipated declines in response to warmer than typical days, increases in cultured and resident plant and animal biomass, and the potential for microbial respiration. Under the manual sampling schedule considered in this analysis DO declines between mid-afternoon (2 PM) and 10 PM will not be detected. Declines at either dawn or dusk can result in stress or potential death if oxygen concentrations were to decline significantly.

As noted above a substantial portion of the additional aeration time occurred during the later sampling period (Fig. 2 and 3). Over 1800 minutes of additional aeration was applied to fewer ponds than during the early sampling period. This highlights a second area of potential importance for automated oxygen management. During this later sampling period the cooler temperatures correspond (intuitively) with lower oxygen consumption in response to lower metabolism. As a result of this pond managers will likely decrease the frequency of monitoring activity. While we did not account for decreased manual sampling in our scheme there were still indications of significant oxygen deficiencies (additional aeration requirements).

PCA (Principle Components Analysis) and ANOVA (Analysis of Variance) were run to try to determine other factor(s) that could have resulted in the 28 ponds needing additional aeration. PCA results concluded that the oxygen and temperature means, medians and ranges were the most important statistical measurements to consider and demonstrated the inverse physical/chemical relationship between oxygen concentrations and temperature (increasing oxygen solubility with decreasing temperatures). Results from the ANOVA illustrate that ponds with higher areas have slightly more variable oxygen concentrations. In this case further improvements might be realized through the use of several automated monitors could be more useful in collecting the representative oxygen concentrations across the entire pond, as opposed to manually checking the larger pond at only one point that may or may not be representative of the overall oxygen concentration. Also, ponds that contain catfish and prawn consumed more oxygen than ponds that contained only plants or only water, signaling the importance in considering species composition and biomass when designing oxygen sampling approaches. No other significant differences were observed in either analysis, but this analysis did not include stocking and feeding rates, which have the potential to be confounding factors. Regardless of the cause of DO variability, the use of automated oxygen monitoring and aerator control can simplify operations and provide an added level of confidence in water quality management.

An increase in net return on investment is a primary motive in the continuously growing catfish industry, and all catfish operations want to increase their productivity (Hargreaves & Tucker, 2003). Automated water quality monitoring and control systems have the potential to contribute to an increase in production and profit. Aerators are only activated when DO decreases below a desired level, reducing energy and night labor crew expenses to a minimum. Automated monitors also detect those outlier ponds that could potentially fall to fatal DO concentrations in cooler/cold months when DO is not manually checked at all or as frequently as it is in warmer/hot months. These unpredicted occurrences could have a significant effect on total net returns, an effect the producer would not have anticipated without the help of au-

Comparison of Automated versus Manual Monitoring of Levels of Dissolved Oxygen in Aquaculture Ponds

Fortune, et al

Automatic monitors. Implementation of the automated oxygen monitors could profoundly impact water quality management and reduce production losses due to low DO fishkills.

Literature Cited

Campbell Scientific, Inc. (2005). Aquaculture: Automated Water Quality Monitoring & Control Systems. Retrieved April 6, 2006, from www.campbellsci.com/aquaculture.

Colt, John (2006). Water quality requirements for reuse systems. *Aquacultural Engineering*, 34, 143-156.

Drapcho, C.M., & Brune, D.E. (2000). The partitioned aquaculture system: impact of design & environmental parameters on algal productivity & photosynthetic oxygen production. *Aquacultural Engineering*, 21, 151-168.

Hargreaves, John A., & Tucker, Craig S. (2003). Defining loading limits of static ponds for catfish aquaculture. *Aquaculture Engineering*, 28, 47-63.

Wetzel, Robert G. (2001). *Limnology: Lake and River Ecosystems* (3rd ed.). California: San Diego, pp 196.

Wetzel, Robert G., Likens, Gene E. (1991). *Limnological Analyses* (2nd ed.). New York: New York, pp 69.

Aquatic Phytoremediation of CCA and Copper Contaminated Water

Cyle Keith, H. Borazjani, S.V.Diehl, M.L. Prewitt, Y.Su, Fengxiang Han and B.S. Baldwin
College of Forest Resources
Mississippi State University
Box 9820
Mississippi State, MS 39762
662-325-2116
Email: hborazjani@cfr.msstate.edu

ABSTRACT

The removal of selected metals by duckweed (*Lemna minor*) and parrotfeather (*Myriophyllum aquaticum*) from a simulated aqueous environment contaminated with Chromated Copper Arsenate (CCA) and copper sulfate was studied in a controlled laboratory experiment. The duckweed and parrotfeather's tissues were analyzed to evaluate the removal of copper (Cu), chromium (Cr), and arsenic (As) from CCA contaminated water (125 mg/L Cu, 220 mg/L Cr, and 205 mg/L As) and from copper sulfate contaminated water (60 mg/L Cu) over a 7 day period. The vigor of the plants was also recorded during this period. The results showed that the duckweed and parrotfeather both removed the metals from the water in each experiment. For the CCA contaminated water study, duckweed removed approximately 60% of each metal from solution while parrotfeather removed approximately 45% of each metal. For the copper contaminated water study, duckweed removed approximately 85% of the copper concentration from solution while parrotfeather removed approximately 77% copper from solution. As for the vigor of the plants in the CCA study, duckweed remained rather healthy throughout most of this study. Parrotfeather sharply declined in vigor after two days into experiment. In the copper study, both plants remained fairly healthy through the duration of the experiment.

Keywords: Water Quality, Surface Water, Nonpoint Source Pollution

Introduction

Chromated copper arsenate, also known as CCA, has been one of the most widely used and best known wood preservatives in the wood industry. Concerns regarding leaching of arsenic from playground equipment constructed of CCA treated wood and a greater public awareness of potential dangers from arsenic in drinking water resulted in various EPA rulings and the wood treating industry's decision in December 2003 to voluntarily halt the production of CCA treated wood for residential use (Hauserman, 2001, Pawlitz et al., 1997, Shalet et al., 2006, Smith et al., 1998, Saxe et al., 2006). Periodic application of copper sulfate CuSO_4 to commercial channel catfish as parasitic control or algicide

have also resulted in copper accumulating four to five times higher in treated pond sediments than untreated pond sediments (Han et al. 2001). The high level of Cu in sediment could have long-term toxicological effects on pond phytoplankton hindering its critical role in maintaining suitable water quality for fish production (Han et al. 2001). Thus, cost-effective and environmentally friendly methods for the clean up of CCA and Cu contaminated sediments and water are needed (Shimp et al, 1993, Kakitani et al. 2006).

Presently there are several options for treating contaminated water (Kakitani et al. 2006). The most common technique is a coagulation/filtration method that involves removing pollutants by chemically conditioning particles to

agglomerate into larger particles that can be separated and settled. This scheme is followed by running the contaminated water through various filters that trap and hold the pollutants for disposal. This method for cleanup is usually disruptive to the environment that surrounds the contamination and not cost efficient.

Recently, a promising alternative remediation technique, called phytoremediation that can be utilized in certain situations to replace other costly methods has been explored (Shimp et al. 1993, Huang et al, 2004, Kakitani et al, 2006). Phytoremediation is the use of plants to absorb certain contaminants from soil or water through a plant's root system into the body of the plant where they are stored and ultimately disposed (Huang et al. 2004). The optimal results for successful phytoremediation would be the maximum removal of heavy metals from contaminated water with a minimal level of phytotoxicity to the plant tissues. The interaction between phytotoxicity, metal accumulation and plant species is highly complex and requires research.

The objectives of this study were to evaluate the removal of arsenic, chromium, and copper by aquatic plants during phytoremediation and to observe the effects of these metals on the health and vigor of the plants.

Methods and Materials

Hydroponic Study

Survival and Selection Test

Four sets of aquatic plants were screened in a preliminary trial, duckweed (*Lemna minor*), water lily (*Nymphaea* spp.), parrotfeather (*Myriophyllum aquaticum*), and an azolla (*Azolla filiculoides*)/duckweed (*Lemna minor*) mixture. Each plant was divided into two groups with three jars in each group. One group served as a control, and the other as the treatment group. In the treatment groups, 100 ml of CCA solution (adjusted to 5 mg/L arsenic, 7 mg/L chromium, and 2.5 mg/L copper concentrations) was added to each jar. The plants were placed into each respective jar and allowed to sit for 5 days. All plant samples were collected, dried, digested, and a chemical analysis performed to see which plants were better accumulators of selected metals. Duckweed and parrotfeather were selected for further studies

based on these results (Table 1).

Table 1. Screening results from preliminary trail.				
Plant Selection Test				
Plant Species	Metal Analysis (mg/kg)			Tolerance
	Arsenic	Chromium	Copper	
<i>Duckweed</i>				
control	14	19	86	good
treatment	9199	30952	18020	good
<i>Parrotfeather</i>				
control	6	4	226	good
treatment	5381	14489	5239	fair
<i>Water lily</i>				
control	1	0	26	good
treatment	729	3354	4275	fair
<i>Azolla/Duckweed</i>				
control	15	0	272	good
treatment	4509	21403	15211	fair

Selected Species Study

Duckweed: CCA Phytoremediation Experimental Design

The CCA solution was adjusted to a 205 mg/L arsenic concentration, 220 mg/L chromium concentration, and 125 mg/L copper concentration. Duckweed was obtained from the Department of Plant and Soil Sciences at Mississippi State University. Sixteen 500 ml glass jars were obtained and labeled. Eight jars were the control group and eight were to serve as the treatment group. In each group, approximately 5-6 grams of duckweed plants were added to four jars and the other four contained no plants for comparative purposes. In the treatment group, 100 ml of the CCA solution (consisting of CCA, de-ionized water, and Miracle-Gro) was added to each jar. In the control group, the jars were filled with 100 ml of the de-ionized water/Miracle-Gro solution. The plants were allowed to sit for 7 days under the fume hood with monitored light conditions and a consistent temperature approximately 24 °C.

Parrotfeather: CCA Phytoremediation Experimental Design

The same CCA solution prepared for the duckweed hydroponic study was used for the parrotfeather hydroponic study. Parrotfeather (*Myriophyllum aquaticum*) was obtained from the Department of Plant and Soil Sciences at Mississippi State University. Sixteen 500 ml glass jars were obtained and labeled. Eight jars served as the control group and eight jars served as the treatment group. In each group, parrotfeather plants were added to four jars and four jars were left without plants for comparative purposes. In the treatment jars, 100 ml of the CCA solution (consisting of CCA, de-ionized water, and Miracle-Gro) was added to each jar. In the control group, the jars were filled with 100 ml of the de-ionized water/Miracle-Gro solution. Parrotfeather plants were allowed to sit for 7 days under the fume hood with monitored light conditions and a consistent temperature approximately 24 °C.

Duckweed: Cu Phytoremediation Experimental Design

Sixteen 500 ml glass jars were obtained and labeled. Eight jars served as controls and were filled with 100 ml of de-ionized water/Miracle-gro. Four jars received three teaspoons (5-6 grams) of duckweed per jar and four jars were left without plants for comparative purposes. The second eight jars were to act as the treatment group. Each of these jars were filled with 100 ml of a water/Miracle-gro mix that had been amended with Cu SO₄ (adjusted to 60 mg/L copper concentration). Four jars were given three teaspoons (5-6 grams) of duckweed and four jars were left without plants for comparative purposes. The plants were allowed to sit for 7 days under the fume hood with monitored light conditions and a consistent temperature of around 24 °C.

Parrotfeather: Cu Phytoremediation Experimental Design

Sixteen 500 ml glass jars were obtained and labeled. Eight jars served as controls and were filled with 100 ml of de-ionized water/Miracle-gro only. Four jars received one healthy parrot feather per jar and four jars were left without plants for comparative purposes. The treatment group had eight jars. Each jar was filled with 100 ml of water/Miracle-gro that had been amended with Cu SO₄ (adjusted to 60 ppm copper concentration). Four jars were given a parrot-

feather per jar and the other four were left without plants for comparative purposes. The plants were allowed to sit for 7 days under the fume hood with monitored light conditions and a consistent temperature approximately 24 °C.

Chemical Analysis

Water samples were taken before and after the experiment from each jar. All plant samples were collected from containers, washed in 3% HNO₃ and de-ionized water, and weighed. The plant tissues were then dried, ground, and weighed. Plant samples (approximately 0.2 g) were digested in HNO₃ and H₂O₂ (Han and Banin, 1997). The digested plant and water samples were then filtered and analyzed for As, Cr, and Cu using inductively coupled plasma-atomic emission spectrometry (ICP-AES).

Results and Discussion

CCA Hydroponic Study

The average total concentrations of arsenic, chromium, and copper in water samples before planting and after the harvest of duckweed and parrotfeather are shown in figures 1 and 2. Duckweed and parrotfeather both showed significant removal of all three metals from the water samples. Duckweed, however, showed the greatest metal removal from the water with approximately 60% of each metal removed from solution. Parrotfeather removed approximately 45% of the metals from the water samples.

The average total metal concentrations in the plant tissues of duckweed and parrotfeather are presented in Table 2. Duckweed accumulated more metals into the plant tissues than did parrotfeather. Duckweed accumulated about twice the chromium than arsenic and about four times more chromium than copper. One reason that the aquatic plants were able to remove more of the heavy metals from the water than terrestrial plants could from soil is the soluble form of the metals in water. Metals must be in a soluble form in soils before plants can absorb them. In an aqueous solution, metals are already in soluble form so accumulation by the plants can be achieved much easier. Also, water is homogeneous and metal concentrations are uniform throughout the water sample.

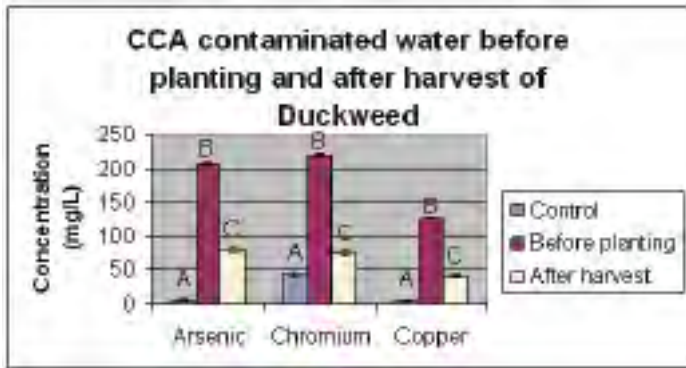

Figure 1. Average metal concentration of arsenic, chromium, and copper in CCA contaminated water before planting and after the harvest of duckweed. Columns with the same letter indicate no significant difference in concentration values at the $\alpha = .05$ probability level. Error bars represent standard deviations.

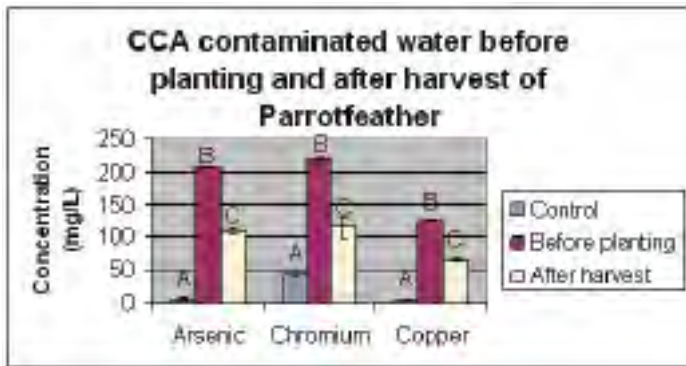

Figure 2. Average metal concentration of arsenic, chromium, and copper in CCA contaminated water before planting and after the harvest of parrotfeather. Columns with the same letter indicate no significant difference in concentration values at the $\alpha = .05$ probability level. Error bars represent standard deviations.

Copper Hydroponic Study

The average total concentrations of copper in water samples before and after the harvest of duckweed and parrotfeather are shown in figures 3 and 4. Duckweed and parrotfeather both showed significant removal of copper from the water samples. Duckweed removed the greatest

Table 2. Metal concentrations in duckweed and parrotfeather tissues.

Plant species	Metal Analysis (mg/kg)		
	Arsenic	Chromium	Copper
Duckweed			
control	0	33	80
treatment	11,828	2,728	5,322
Parrotfeather			
control	0	0	31
treatment	2,766	6,152	1,809

Table 3. Copper concentrations in duckweed and parrotfeather tissues.

Plant Species	Metal Analysis
	(mg/kg)
Copper	
Duckweed	
control	76
treatment	19,037
Parrotfeather	
control	251
treatment	8,414

amount of copper with around 85% being removed from solution. Parrotfeather removed around 77% of the copper from the water samples.

The average total copper concentrations in the plant tissues of duckweed and parrotfeather controls and treatment plants are given in Table 3. Duckweed accumulated over twice the amount of copper into its plant tissues as did parrotfeather. This could be due to an increased surface area of the duckweed compared to parrotfeather or because duckweed is a better accumulator of copper than parrotfeather.

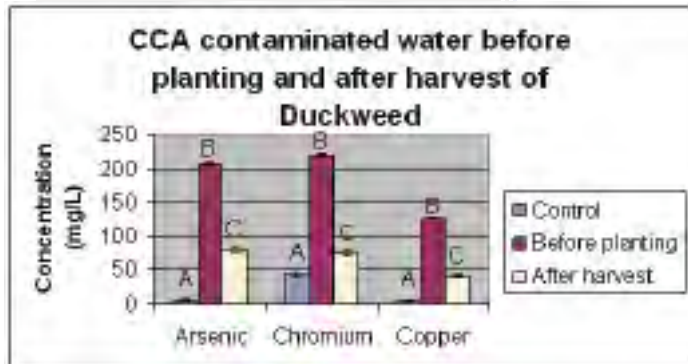

Figure 3. Average concentration of copper in Copper contaminated water before planting and after the harvest of duckweed. Columns with the same letter indicate no significant difference in concentration values at $\alpha = .05$ probability level. Error bars represent standard deviations

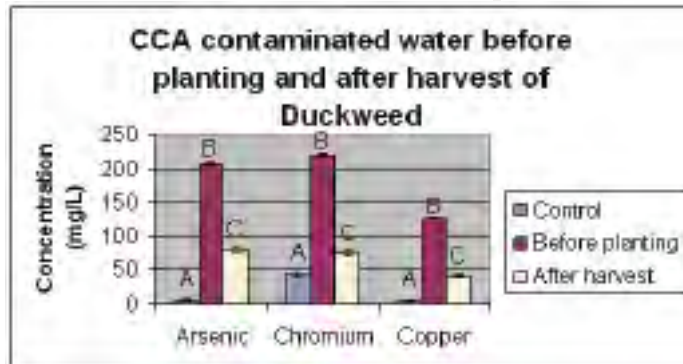

Figure 4. Average concentration of copper in Copper contaminated water before planting and after the harvest of parrotfeather. Columns with the same letter indicate no significant difference in concentration values at $\alpha = .05$ probability level. Error bars represent standard deviations.

Conclusion

Duckweed and parrotfeather were both found to be effective accumulators of the metals present in CCA and copper contaminated water. Duckweed could be considered a superior accumulator because of its ability to remove large concentrations of metals and remain vigorous and healthy. These studies have shown that certain plants can have remedial effects on metals in aqueous environments. More research is needed to better understand the symbiotic or antagonistic relationship between plants and metals. Also, the results obtained from the hydroponic experiment described in this paper could provide good preliminary data for using aquatic plants in remediating contaminated lakes or lagoons.

Acknowledgment

The article is approved for publication as Journal Article FP-409 of Forest & Wildlife Research Center, Mississippi State University, Mississippi State, MS.

References

Cong, T. and L. Q. Ma. 2002. Effects of arsenic contamination and forms on arsenic uptake by hyperaccumulator ladder brake. *J. Environ. Qual.* 31: 641-647.

Han, F.X. and A. Banin. 1997. Long-term transformations and redistribution of potentially toxic metals in arid zone soils. *Water, air, and soil pollution.* 95: 399-423.

Han, F.X. J.A. Hargreates, W.L. Kingery, D.B. Haggett, and D.K. Schlen K. 2001. Accumulation, distribution land toxicity of catfish ponds receiving periodic copper sulfate application. *J. Environ. Qual.* 30: 912-919.

Hauserman, J. 2001. The poison in your back yard. *St. Petersburg Times*, March 11, 2001.

Huang, W. H., Poynton, C.Y. Kochian, L. V. and Elless, M. P. 2004. Phytoremediation of arsenic from drinking water using hyper-accumulating ferns. *Environmental Science and Technology* 38: 3412-3417.

Kakitani, T., T. Hata, T. Kajimota, and Y. Imamura. 2006. Designing a purification process for chromium, copper, and arsenic contaminated wood. *Waste Management* 26: 453-458.

Pawlisz, A.V., Kent R.A., Schneider U.A. and Jefferson C. 1997. Canadian water quality guidelines for chromium. *Environ. Toxicol. Water Qual.* 12(2). 123-183.

POSTER SESSION

Aquatic Phytoremediation of CCA and Copper Contaminated Water

Keith, et al

Saxe, J.K., E.J. Wannamak., S.W. Conklin, T.F., Shupe, and B.D. Beck. 2006. Evaluating landfill disposal of chromated copper arsenate (CCA) treated wood and potential effects on groundwater: Evidence from Florida. *Chemosphere* (in press).

Schnoor, J.L. 2000. Phytostabilization of metals using hybrid poplar trees. in: *Phytoremediation of Toxic Metals.: Using Plants to Clean Up the Environment*, Pages 133-150. I. Raskin and B.D. Ensley, eds. John Wiley & Sons, Inc., New York.

Shalat, S.L., H.M. Solo, Gabriel, L.E. Fleming, B.T. Buckley, K. Black, M. Jimenez, T Shibata, M. Durbin. 2006. A pilot study of children's exposure to CCA-treated wood from play-ground equipment. *Sci. Total. Enviro.* 367: 80-88.

Shimp, J.F., J.C. Tracy, L.C. Davis, E. Lee, W. Huang, L.E. Erickson, and J.L. Schnoor. 1993. Beneficial effects of plants in the remediation of soil and groundwater contaminated with organic materials. *Crit. Rev. Environ. Sci. Technol.* 23:41-77.

Smith, E., R. Naidu, and A.M. Alston. 1998. Arsenic in the soil environment: A review. *Adv. Agron.* 64: 149-195.

Effects of Attenuation and Dispersion Factors on Tebuthiuron Leaching Simulation

Claudio A. Spadotto¹, Marcus B. Matallo², Marco A.F. Gomes¹, Luiz C. Luchini³, Antonio L. Cerdeira¹

¹Brazilian Department of Agriculture, Agricultural Research Service, EMBRAPA/Environment, Jaguariúna, SP, Brazil

²Weed Science Laboratory, Biological Institute, IB, Campinas, SP, Brazil

³Agrochemicals Ecotoxicology Laboratory, Biological Institute, IB, São Paulo, SP, Brazil

Abstract

Differences on response of mathematical models on herbicide leaching in the environment can occur due to the models and their limitations, mainly when using soil lysimeters. Tebuthiuron is a herbicide used in sugarcane crop and is applied in the recharge area of the Guarany aquifer in Brazil, one of the largest in the world. This study was conducted to compare the leaching potential of the herbicide within lysimeters using sandy soils of the Espraiado watershed in the recharge area from the region of Ribeirão Preto, SP, Brazil. The traditional Attenuation Factor (AF) model was used at various soil layers, adding a Dispersion Factor (DF) to the model. The fitness of the model was good for the total amount of tebuthiuron leached, but not for the rate of leaching. The model overestimated the level of herbicide leaching at 100 days after application, but the final concentration leached with the water was as predicted by the model.

Key Words: Agriculture, Ground Water, Nonpoint Source Pollution, Solute Transport, Water Quality.

Introduction

The region of Ribeirão Preto city, São Paulo, Brazil, is an important sugar cane producing area where high volume of pesticide is used. It is also a recharge area of the Guarany Aquifer the main ground water source in South America and one of the biggest of the world.

The diffuse rural pollution of a pesticide can be a significant source of water contamination. In a recent research Matallo *et al.* (2003), studied the risk of ground water contamination of the Espraiado watershed, located in the recharge area, with the herbicide tebuthiuron and concluded that although there was a potential risk, the herbicide would not reach the water table. Matallo *et al.* (2004), also concluded with studies with lysimeters that the AF model ("Attenuation Factor"), fitted best to sandy soils of the region and that this was due, among other factors, to the dispersion and/or convection attributed to the soil columns.

In order to further understand the process, this work was conducted with mini lysimeters to evaluate the effect of

adding into the AF model the dispersion factor to improve the fitness of the model.

Material and methods

The properties of the sandy soil chosen for this study, Typic Quartzipsamment were determined in a previous study conducted by Matallo *et al.* (2003) (Table 1). Data of depths below 50 cm down to the saturate zone of the aquifer were based on the average values found in literature. Water recharge index was calculated based on the

Table 1. Typic Quartzipsamment soil properties of the recharge area of Guarany Aquifer at the Espraiado watershed in Ribeirão Preto, SP, Brazil.

Soil properties	Depths range(cm)		
	0-12	12-22	22-50
Field Capacity (%)	20.13	18.41	18.06
Density (g/cm ³)	1.20	1.07	1.26
Organic carbon (%)	0.24	0.15	0.02

difference of rain and evapotranspiration of the Espirado Watershed area.

The sorption coefficient (K_d) values at the different depths were determined as 0.4; 0.2; and 0.1 mL/g, at of 0-12, 12-22, and 22-50 cm depths. The leaching potential of the herbicide in lysimeter was evaluated by the multi-layered AF model. AF, is defined as a fraction of the pesticide applied to the soil surface that leaches to a determined depth (Rao et al. 1985). It is fitted in the following equation:

$$(1) AF = \exp(-tr \times k)$$

where tr is the duration of leaching and k is the first order constant of degradation of the herbicide in the soil. K is dependent on the half-life ($t^{1/2}$) of the herbicide and can be expressed by the following equation:

$$(2) k = \frac{0.693}{t^{1/2}}$$

The travel duration or leaching time (tr) can be expressed by the following equation:

$$(3) tr = \left(\frac{L \times FC}{q} \times RF \right)$$

where L is the depth of the water table or aquifer, FC is field capacity, and q is the net water recharge index.

The Retardation Factor (RF) of the herbicide leaching was obtained by the following equation:

$$(4) RF = 1 + \frac{(BD \times OC \times K_{oc})}{FC}$$

where BD is soil density, OC is organic carbon, K_{oc} is the sorption coefficient of the herbicide and (K_d) is sorption coefficient adjusted to the organic carbon content of the soil.

The Dispersion Factor was obtained according to the following equation developed by Ogata (1970):

$$(5) fd = \frac{1}{2} \left[\operatorname{erfc} \left(\frac{L - v \cdot t}{2\sqrt{D \cdot t}} \right) + \exp \left(\frac{v \cdot L}{D} \right) \cdot \operatorname{erfc} \left(\frac{L - v \cdot t}{2\sqrt{D \cdot t}} \right) \right]$$

where, erfc represents the complementary error function, L is the length of the lysimeter in meters, v is the average speed of water in the soil ($m \cdot s^{-1}$), t is the time of the herbicide application, and D is the longitudinal dispersion coefficient ($m^2 \cdot s^{-1}$).

The Average Speed (v) of water movement in the soil ($m \cdot s^{-1}$) was calculated by:

$$(6) v = \frac{K}{n} \cdot \frac{dh}{dl}$$

where K represents hydraulic conductivity ($m \cdot s^{-1}$), and n is the effective soil porosity and dH/dl is the hydraulic coefficient.

The Longitudinal Dispersion Coefficient (D), ($m^2 \cdot s^{-1}$), can be expressed by:

$$(7) D = a \cdot v + D^*$$

Where a is the dynamic dispersivity (m) and D^* is the molecular diffusion ($m^2 \cdot s^{-1}$).

Results and Discussion

The model fitted well to the total amount of leaching (Table 2) but even with adjustments was not able to explain the initial amounts leached. The model also did not explain a peak of leaching at 100 days after application of the herbicide (Figure 1), which was not confirmed by the measured data set. On the other hand, the model fitted well at the end of the dispersion curve 150 days after application (Figure 1).

Table 2: Predicted by the AF model and observed amount (μ/g) of tebuthiuron leaching.

Predicted	Observed
703.9	799.6
¹ Average of 2 samples	

The elution curve reflects the combined effects of diffusion and hydrodynamic dispersion of a solute through soil (Biggar and Nielsen, 1962). In this way, the differences of the models and experimental data of leaching could be due to the sorption of the herbicide in the macropores allowing its

detection in the first days of the experiment.

In this process, the water and solute fraction moving through macropores would be retained for a longer period and, since the solutes keep moving through macropores the amount of the herbicide leached would vary, explaining the peaks of the measured data at 150 days after application (Figure 1).

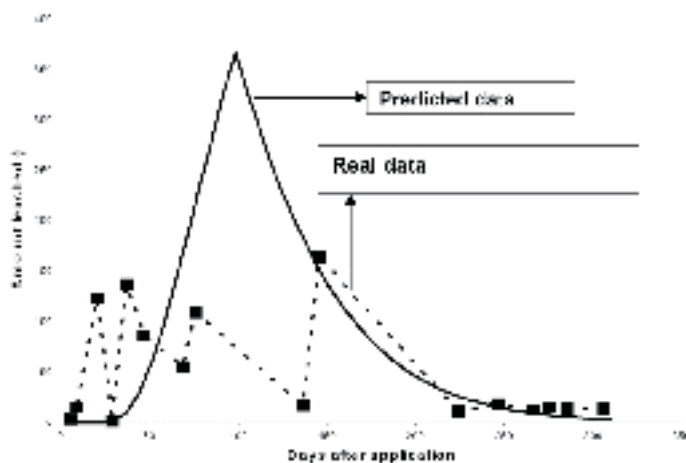

Figure 1. Tebuthiuron elution in the soil.

On the other hand, tebuthiuron retention in micropores can not be ignored, being a process similar to the adsorption not being retained by physical or chemical bounds and its leaching would be retarded explaining the differences observed and predicted of the experiment and also explaining the adjustment of the model AF at the end of the experiment at 150 days. This hydrodynamic behavior was described by Romero *et al* (2001) using the model PESTLA to describe the movement of racemics and enantiomers herbicides such as mecoprop and dichlorprop in sandy loam soils with high levels of calcium.

It is also important to consider the normal degradation process which occurs during the leaching period and could also explain the initial behavior of the herbicide. According to Matallo *et al.* (2003), the degradation of the herbicide is better fitted in a bi-exponential equation in the upper layer of the soil (0-12 cm), meaning that the degradation is initially rapid ($t_{1/2} = 1.3$ days) then followed by a much slower process ($t_{1/2} = 1,386$ days). Because of this, we have used

for the equation just half of the rate of the herbicide and by doing so a higher half-life. This was done because if there is no rain after the application, the herbicide would stay at the soil surface where would quickly degrade to half of the rate followed by a slower degradation. Also, in case of higher moisture followed by rain, the herbicide would leach more rapidly to deeper layers, where the degradation is slower.

Conclusion

The AF model predicted well the total amount of the herbicide leached in Typic Quartzipsamment soil but even with the inclusion of the dispersion factor to the model it did not fit well during the first 150 days after the herbicide application and adjusted better at the end of the period. This behavior could be due to the dispersion and diffusion of the herbicide in the micropores associated with the differential movement of water through soil pores.

References

- BIGGAR, J.W.Y.; NIELSEN, D.R. Miscible displacement: II. Behavior of traces. *Soil Sci. Soc. Amer. Proc.*, 125-128, 1962.
- MATALLO, M.B.; LUCHINI, L.C.; GOMES, M.A.F.; SPADOTTO, C.A.; CERDEIRA, A.L.; MARIN, G.C. Lixiviação dos herbicidas tebutiuron e diuron em colunas de solo. *Pesticidas: R. Ecotoxicol. e Meio Ambiente*, 13:83-90, 2003.
- MATALLO M.B.; SPADOTTO, C.A.; LUCHINI, L.C.; GOMES, M.A. Sorption, degradation and leaching of tebutiuron and diuron in soil columns. *J. Env. Sci. Health Part B – Pesticides, Food Contaminants and Agricultural Wastes*, B40(1):1-6, 2004.
- RAO, P.S.C.; HORNSBY, A.G.; JESSUP, R.E. Indices for ranking the potential for pesticide contamination of groundwater. *Soil Crop Sci. Soc. FL Proc.*, 44:1-8, 1985.
- OGATA, A. Theory of dispersion in a granular medium. U.S. Geological Survey Professional Paper, 411-I, 1970.

POSTER SESSION

Effects of Attenuation and Dispersion Factors on Tebuthiuron Leaching Simulation
Spadotto, et al

ROMERO, E.; MATALLO. M.B.; PEÑA, A.; SÁNCHEZ-RA-SERO, F. ; SCHMITT-KOPPLIN, Ph.; DIOS, G. Dissipation of racemic mecoprop and dichlorprop and their pure R-enantiomers in three calcareous soils with and without peat addition. Environ Pollut., 111:209-215, 2001.

POSTER SESSION

Conservation Planning integrating site assessment and hydrologic modeling at the Mississippi State University Dairy Unit, Sessums, MS

Timothy J. Schauwecker, Jeremy Murdock, Kim Collins
Department of Landscape Architecture
Mississippi State University
PO Box 9725
Mississippi State, MS 39762
662-325-7895
Email: tschauwecker@lalc.msstate.edu

ABSTRACT

Reducing non-point source pollution associated with agricultural production is a high priority for policy makers and researchers. The test case of a 10-acre dairy farm headquarters was used to compare hydrologic modeling outcomes using HSPF to evaluate before- and after-installation effects of Best Management Practices (BMPs). The test site is a part of the Mississippi Agricultural and Forestry Experiment Station Dairy Unit, an 880-acre facility consisting of a dairy production facility, pasture, row crop and riparian forest in northeast Mississippi. The MAFES Dairy Unit is adjacent to Catalpa Creek in the Tibbee Creek watershed. Catalpa Creek was evaluated to determine its' condition before research into BMP implementation began, so that baseline data can be compared to conditions following future improvements. After an extensive site assessment of the production headquarters, opportunities for improving runoff were explored, and included the design of a vegetated swale that would slow runoff from the dairy production site and act as a buffer in the event of an overflow from adjacent treatment lagoons. HSPF was used to evaluate the effectiveness of this and other BMPs that were placed in the landscape. Future work and research will evaluate the entire site and include cost/benefit analyses of BMPs that are identified as potentially beneficial to water quality, control of water quantity, and increase wildlife habitat. The Conservation Planning process will be improved through the use of these tools, which allow multiple scenarios to be tested for their efficacy before final decisions are made as to land management practice.

Keywords: Agriculture, Hydrology, Management and Planning, Surface Water, Water Quality

Background

The Mississippi Agricultural and Forestry Experiment Station (MAFES) Dairy Unit is an 880-acre dairy production and research site. The site was chosen for research into conservation planning and design. The first stage of research included a hydrologic assessment of the headquarters and dairy production facility. Conservation practices selected for modeling were determined through consultation with Mississippi State University Department of Animal Sciences faculty, Dairy Unit staff, and MAFES administration. The primary concern was potential overflow of the treatment lagoon system. Also of research interest are agricultural impacts to Catalpa Creek, an impaired waterbody running through the southern portion of the site.

Methods

The Latis© framework (Wilkerson et al. 2006) was employed to investigate the effectiveness of conservation practices and their associated costs and benefits. Hydrologic assessment included calculation of sub-basin areas for the dairy production headquarters in ArcView™ and modeling of existing site runoff using BASINS/HSPF (Bicknell et al. 2001). A consultation with Dairy Unit staff and faculty members was conducted to determine their concerns regarding site hydrology. Their comments were used to help in determining site design needs and criteria. Prior to the selection or design of Best Management Practices (BMPs) for the property, an inventory and analysis of existing conditions was necessary to better understand the needs on the property. The

Conservation Planning integrating site assessment and hydrologic modeling at the Mississippi State University Dairy Unit, Sessums, MS

Murdock, et al

site visits included a windshield survey of the entire 880-acre agricultural operations, a guided tour of the Dairy Unit facility that included demonstrations of the day-to-day operations, and two visual stream assessments of two reaches (Reach A and Reach B) of Catalpa Creek which runs through the southern portion of the property. The results of the site visits were used to identify potential problem areas throughout the farm, especially the areas directly affecting Catalpa Creek. Conservation practice design for the headquarters area included water harvesting, the placement of a vegetated swale adjacent to onsite treatment lagoons, and the conversion of a grass-dominated area on the site to woodland. The site was then modeled in HSPF taking the conservation practices into account. The design storm used for modeling occurred on November 1-17, 1993. A determination of costs associated with BMP installation and maintenance was performed using BUBBA (Wilkerson et al. 2006), a BMP selection spreadsheet that is an integral part of Latis.

Three observers from the Department of Landscape Architecture at Mississippi State University performed a visual assessment study of Catalpa Creek to determine the overall condition of the creek based on the USDA Stream Visual Assessment Protocol (USDA 1998). This document outlines specific criteria for assessing a stream, creek, or river and includes a scale for grading the overall condition of the water body. The assessment of the middle two-thirds (Reach A) of the property reach was conducted on June 14, 2006, and the assessment of the upper one-third (Reach B) of the property reach was conducted on June 22, 2006. The two reaches accounted for approximately the upper two-thirds of the creek present on the property. The lower third of the property reach was not assessed using the stream assessment protocol.

Results and Discussion

Consultation with Dairy Unit Faculty and Staff

The tour of the Dairy Unit headquarters identified several areas that could lead to potential environmental hazards on the property. The major concern of the researchers and the Dairy Unit manager was the undersized waste treatment lagoons. The lagoons pose a serious environmental threat

because a potential overflow would pollute Catalpa Creek, potentially causing a fish kill in the creek as well as the catfish ponds downstream that uses water from the creek for its operations. The employees expressed the need for excess capacity in the lagoons or a buffer between the lagoons and the adjacent stream which flows directly into Catalpa Creek.

The guided tour of the Dairy Unit headquarters allowed the researchers to understand the every-day operations of the dairy as well as the common problems encountered by the employees. The major concern of the dairy manager was the waste treatment lagoons. The two-lagoon system was not properly sized to meet the needs of the dairy operation and is highly likely to overflow causing a major environmental hazard. If an emergency overflow occurs, the effluent will enter the adjacent stream and flow directly into Catalpa Creek. This could cause a fish kill in the creek or in the catfish farm downstream that uses water from the creek for its operation. This was the main concern of the researchers and led to the selection of the Dairy Unit headquarters as the site for this study.

Stream Assessment

Following a visual assessment of Catalpa Creek, the three observers evaluated the creek separately using the grading scale in the protocol. The conclusion of all three observers was that the reach of Catalpa Creek on dairy unit property was in poor condition. The observations included heavy hydrologic alteration and channelization of the reach, erosion of the creek bed, evidence of clear-cutting was present in the riparian zone of the creek banks, resulting in reduced cover for fish species and aquatic insects. There were, however, various types of in-stream fish cover, limited barriers to fish movement, and numerous types of aquatic insect habitats. A variety of Group I, II, and III macro-invertebrates were observed throughout the dairy unit reach, which shows the varying conditions of the creek. Group I invertebrates, which are very intolerant of pollutants included Riffle beetles, Gilled snails, and a Dobsonfly (Hellgrammite). The presence of Group I invertebrates indicates that while the physical conditions of much of the reach has been altered, water quality has not displaced them from portions of the

stream, which is encouraging for long-term management. Approximately one-fifth of the reach has not experienced significant streamcourse alteration. The group II invertebrates, which are moderately tolerant of pollutants, were crayfish, damselfly larvae, damselflies, dragon fly larvae, dragon flies, mussels and clams. Finally, the group III invertebrates, which are very tolerant of pollutants, observed were leeches and snails. Other invertebrate species could possibly be found in the creek using benthic organism retrieval equipment.

Root systems appeared to partially stabilize the banks within the reach, but signs of erosion are present. No concrete swales or riprap was present within the reach. Stream fish cover, aquatic insect habitat, and macro invertebrate species were present. The creek bed was striated for significant portions of the reach, which suggests that the creek channel is continually eroding. The conclusion of the researchers was that if steps are not taken to restore the forest buffers of Catalpa Creek, the health of the creek will deteriorate and more problems will arise. The results of the visual stream assessment identified problem areas within the creek itself and throughout the MAFES property that will eventually be addressed with the selection, design, and potential implementation of stream buffers on the property.

The portions of the farm that were modeled were not immediately adjacent to Catalpa Creek. However, the tributary adjacent to the modeled portion of the site affects Catalpa Creek, and is therefore a part of the overall effort to address the conservation of the creek. Future work will include modeling of conservation practices on the entire 880-acre site.

Hydrologic Modeling

The conservation practices modeled yielded a 72% reduction in flow as modeled in HSPF (Fig. 1).

The costs associated with implementation were:

- \$22,000 for installation of bioretention area at the base of the treatment lagoon levee.
- \$350.00 in annual maintenance cost of streamside buffer
- \$2,400 for installation of two 500-gallon rainwater storage tanks

These measures will be included in a Comprehensive

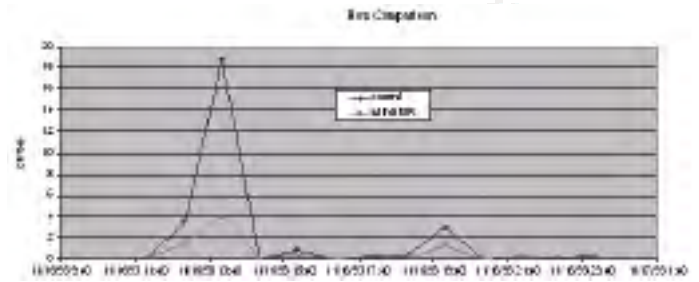

Figure 1. Model results for FLOW in Latis© (BASINS/HSPF)

Conservation Plan (CCP) being developed for the entire site. Future modeling and planning will address agricultural runoff associated with the 880-acre site, a determination of potential costs and benefits of installation of streamside buffers, development of the graphical user interface for agricultural end-users, and field verification of modeling results for all installed conservation practices. End-user needs assessments are underway to aid in the development of the graphical user interface.

An agricultural extension of Latis, FarmLatis, has the potential to aid end-users (resource agency personnel, farmers) in the development of Comprehensive Conservation Plans by allowing for multiple scenarios and outcomes during the initial planning stages.

References

Bicknell, B., J. C. Imhof, J. L. Kittle, T. H. Jobes, A. S. Donigan, Jr., and Hydrologic Analysis Software Support Program, USGS. 2001. Hydrologic Simulation Program- Fortran: HSPF Version 12 User's Manual, National Exposure Research Laboratory, U. S. Environmental Protection Agency, Athens, GA.

United States Department of Agriculture. 1998. NWCC Technical Note 99-1, Stream Visual Assessment Protocol.

Wilkerson, G. W., W. H. McAnally, J. L. Martin, R. Jackson, J. A. Ballweber, G. Savant, S. J. Mulley, C. M. Wallen, and P. Craig. 2006. Latis: Tools to Assess Low Impact Site Development Strategies, Mississippi State University.

POSTER SESSION

Bacterial Source Tracking of a Watershed Impacted by Cattle Pastures

M. Lynn Prewitt, Celina Phelps, Mike Cox, Rick Evans, Susan Diehl
Forest and Wildlife Research Center
Mississippi State University
PO Box 9820
Mississippi State, MS 39762
662-325-4083
Email: lprewitt@cfr.msstate.edu

ABSTRACT

Pathogenic microorganisms introduced by cattle may be transported to distant locations via watershed runoff. *Escherichia coli*, *Enterococcus* spp., and *Streptococcus* spp. are a few species present in runoff from land impacted by humans, cattle, and wildlife. Initial data revealed that *E. coli* concentrations in water were greater in areas impacted by cattle than by humans. And, wildlife contributed greater concentration fluctuations than either humans or cattle. When cattle were removed from a pasture, the bacterial concentrations rapidly decreased; however, slight variations in cattle herd size did not appear to significantly influence these counts. Amplified fragment length polymorphisms (AFLP) and repeated-sequence polymerase chain reactions (rep-PCR) were molecular techniques used in this study to assess the impact of several cattle pastures on one rural communities' watershed system. Preliminary REP-PCR results estimated that 13% of *E. coli* in pasture waters originated from cows.

Keywords: Agriculture, Water Quality, Surface Water

Effect of Swine Effluent Application Rate and Timing on Nitrogen Utilization and Residual Soil Nitrogen in Common Bermudagrass

John J. Read, Geoffrey E. Brink, Ardeshir Adeli and Jim G. Thomas
USDA-ARS, Waste Management and Forage Research Unit
P.O. Box 5367
Mississippi State, MS 39762
662-320-7420
E-mail: JJRead@msa-msstate.ars.usda.gov

ABSTRACT

Frequent summer precipitation may delay the application of swine effluent to bermudagrass [*Cynodon dactylon* (L.) Pers.] until late summer or early fall. A concern with late-season irrigations is declining day length and air temperatures in fall greatly reduce the growth and nutrient uptake of this warm-season forage crop. Field studies were conducted in 2000 and 2001 near Pheba, MS on a Prentiss sandy loam soil (coarse-loamy, siliceous, semiactive, thermic Glossic Fragiudult) with no known history of effluent application. The objectives were to determine if irrigation rate and timing influence crop N utilization and residual $\text{NO}_3\text{-N}$ in the soil profile. Small plots were arranged in completely randomized design with four replicates. Effluent was applied at 10 and 20 cm ha^{-1} (about 260 and 480 kg ha^{-1} N, respectively) during four spray seasons: April to September (full season), April to May, June to July, and August to September. Soil was sampled in fall and spring to estimate the amount of N not recovered by forage. Application of 20 cm effluent in April-May, June-July, and April-Sept treatments resulted in the greatest annual forage yield of about 11.5 and 18.1 Mg ha^{-1} in 2000 and 2001, respectively; the corresponding values for N uptake were 306 and 335 kg ha^{-1} . Averaged across rates, the Aug-Sept treatment had the lowest N utilization efficiencies of 55% in 2000 and 34% in 2001. Application of 20 cm effluent in Aug-Sept treatment increased residual soil NO_3 , particularly in fall 2000 and spring 2001. Nitrogen in swine effluent applied in fall is less likely to be utilized by common bermudagrass due to either dry summer conditions or declining growth rate.

Keywords: Agriculture, Ecology, Irrigation, Ground Water, Wastewater

Introduction

Growth of confined, contract swine production in southeastern USA and widespread use of swine manure as a nutrient source for forage production has focused research on nutrient uptake by southern forages (Welsh and Hubbell, 1999; Adeli et al., 2003; Rowe et al., 2006). The swine manure produced by a farm is typically flushed into anaerobic lagoons to facilitate digestion. The resulting effluent is a solution containing multiple nutrients, including N, P, K, Ca, and Mg, and micronutrients. To prevent lagoon overflow, permits require surrounding pasture land to be irrigated with effluent. Nitrogen, P, and K are the most agronomically important nutrient elements, while N and P also pose an environmental

hazard (Mississippi NRCS, 2000).

Efficient use of effluent N should be a priority because N application rates in excess of crop N requirements contribute to increased levels of NO_3 in the soil profile, and high concentration of post harvest soil NO_3 increases the risk of leaching into ground water (Burns et al., 1990). Bermudagrass is the predominant forage crop grown in the region and responds readily to increasing N rates from either organic or inorganic sources (Read et al., 2006). Because hay production represents an important component of nutrient management, improving N management in bermudagrass fertilized with effluent requires a better understanding of irrigation rate and timing effects relative to the N removal

Effect of Swine Effluent Application Rate and Timing on Nitrogen Utilization and Residual Soil Nitrogen in Common Bermudagrass

Read, et al.

capacity of the crop. By minimizing soil loss and nutrient runoff and by harvesting nutrients in the form of hay, the rate of nutrient accumulation in the soil and potential for ground and surface water impairment is reduced (McLaughlin et al., 2005).

Water quality impacts from land-applied swine effluent are dependent on many variables, including soil, rainfall, plant species, waste characteristics, and application rate. Due to frequent precipitation earlier in the growing season, swine producers in the Southeast may be forced to apply effluent to bermudagrass in late summer or early fall. But declining day length and temperature reduce the growth and nutrient uptake of this tropical forage grass during the fall (Ball et al., 1996). Consequently, late-season applications of effluent increase the potential for excessive N accumulations in soil and nitrate leaching. Our objective was to determine effluent application date and rate effects on bermudagrass yield, N uptake, and post-season residual soil N concentration.

Materials and Methods

The study site was a common bermudagrass hay meadow on a commercial swine farm near Pheba (33.588 N, -88.950 W) in Clay County, MS. A site was selected with no known history of swine effluent application and adjacent to an earthen lagoon used for holding swine effluent. Soil is a Prentiss sandy loam, which consists of deep, moderately well drained, moderately permeable soils with a fragipan. They

formed in loamy marine or stream sediments. In April 2000, the existing bermudagrass sward was cleared of senesced weeds by mowing, and weed regrowth was controlled using selective herbicides [Weedmaster (8 oz acre⁻¹) and MSMA (4 oz acre⁻¹)]. Soil was sampled at 0-5, 5-10, 10-20, 20-30, 30-40 cm depths at several sites within the experimental area. Chemical characteristics of the Prentiss soil are presented in Table 1. The pH was determined in a 1:1 soil and water suspension, total N was determined using the Dumas method (Bremner, 1996), and nutrient concentrations were determined using Mehlich-3 extractant (Mehlich, 1984).

Plots (2 x 6 m) were arranged in randomized complete block design with four replicates. Adjacent plots were separated by a 2-m alley and adjacent blocks were separated by a 4-m alley. Experimental treatments were repeated on the same plot area each year. Treatments comprised non-irrigated and unfertilized (control) plots, plots irrigated with swine effluent at the recommended annual rate of 10 cm ha⁻¹ (approximately 264 kg N ha⁻¹), and plots irrigated at 20 cm ha⁻¹. The amount of effluent provided to each plot was about 1294 ± 58 L for 10 cm ha⁻¹ rate and 2335 ± 228 liters for 20 cm ha⁻¹ rate (Table 2). Application timing was varied by applying effluent at regularly spaced times during the season with 0.5 cm per irrigation event in four spray seasons: (i) April through September (full season), (ii) April through May, (iii) June through July, and (iv) August through September. These treatments were applied by hand from 26 April to 10 October 2000, and from 17 April to 4 October 2001 using

Table 1. Bulk-density (BD), pH, and the concentration of selected mineral elements (Mehlich-3 extractant) at various depths in Prentiss sandy loam soil at the beginning of the experiment.

Depth	BD	pH	N	K	Ca	Mg	P	Fe	Mn
cm	Mg m ⁻³		g kg ⁻¹				mg kg ⁻¹		
0-5	1.11	6.1	2.11	0.44	1.14	0.23	31	306	83
5-10	1.38	5.9	1.48	0.32	0.81	0.08	1	208	76
10-20	1.50	6.0	1.07	0.12	0.71	0.03	0	110	78
20-30	1.54	4.3	0.64	0.03	0.44	0.02	0	103	12
30-40	no data	4.1	0.52	0.03	0.25	0.02	0	115	7

Table 2. Total amount of swine effluent and nitrogen in effluent applied to bermudagrass in different spray seasons during the experimental period.

Effluent Rate and Period	Effluent applied		Total N applied	
	2000	2001	2000	2001
	kiloliters		kg ha ⁻¹	
10 cm ha ⁻¹				
Apr - Sep	1.25	1.25	241	286
Apr - May	1.25	1.32	258	304
Jun - Jul	1.32	1.40	247	318
Aug - Sep	1.25	1.32	197	249
20 cm ha ⁻¹				
Apr - Sep	2.34	2.49	447	520
Apr - May	2.41	2.34	499	533
Jun - Jul	1.95	2.26	378	512
Aug - Sep	2.18	2.72	348	510

a garden hose attached to a centrifugal pump. The pump, which was centrally located in the plot area, drew effluent through a buried, PVC pipe that ran to a lagoon approximately 30 m from the pump. Once inside the earthen wall of the lagoon, the intake pipe floated on the surface to a 90° elbow mounted on a flotation device that allowed effluent to be withdrawn from a depth of 30 cm. Flow rate of the pump was checked at the time of each application so that a 0.5 cm event was equivalent to 3 minutes of irrigation. All water was applied carefully to minimize runoff from the plots. A sample of effluent (~ 250 ml) was collected on each application date and stored in the lab in a freezer. Total N concentration was determined using Kjeldahl procedure with a salicylic acid modification. Values for effluent N concentration and corresponding volume applied each week were used to calculate the annual N rate for each spray season (Table 2).

Forage was harvested every 7 to 9 weeks. Harvest dates in 2000 were 13 June, 7 August, and 11 October. Harvest dates in 2001 were 14 June, 16 August, and 12 October. Corresponding harvest intervals were 6.8, 7.8, and

9.3 weeks in 2000, and 8.2, 9.0, and 8.1 weeks in 2001. Forage biomass was determined by cutting a 1- by 6-m swath at a 3-cm stubble height through the center of each plot using a sickle-bar mower. Fresh weights were recorded and subsamples of oven-dried forage were used for determination of percent moisture in order to calculate forage dry matter (DM) yield. Forage N concentration was determined from duplicate samples using an automated dry combustion analyzer (Model NA 1500 NC, Carlo Erba, Milan, Italy). The quantity of N removed in harvested forage was calculated as a product of DM yield and percent N concentration at each harvest. Apparent N recovery was calculated by subtracting annual N uptake for control treatment from annual N uptake for the effluent treatments and dividing by the amount of N applied. Nitrogen recovery is an important indicator of N use efficiency and potentially reflects relative quantities of N remaining in the soil.

In order to determine residual inorganic N, NO₃ and NH₃, in the soil profile, soil samples were taken after a killing frost (5 December 2000 and 14 November 2001) at depths of 0-5, 5-10, 10-15, 15-20, 20-25, 25-30, and 30-40 cm. Profiles also were sampled before 'greenup' in spring (April of both years) at depths of 0-5, 5-10, 10-20, 20-30, 30-40, 40-50, and 50-60 cm. Sampling depth was deeper in spring because relatively more NO₃ leaching was expected during the winter and spring seasons due to increased rainfall amounts and less plant growth, as compared to summer and fall seasons. Two cores were obtained from each plot using a Giddings Soil Probe mounted on a tractor. Samples of soil were composited by depth, placed in plastic bags, and stored in a freezer to prevent N transformations prior to analysis. Subsamples were extracted with 2 M KCl (1:10 soil:KCl) and the filtrate analyzed colorimetrically for NO₃ and NH₄ using a Technicon autoanalyzer (Mulaney, 1996). Total inorganic N was expressed as the summation of NO₃ and NH₄, using mass units (mg N kg soil⁻¹, parts per million). At the end of the experiment, soil was sampled at 5-cm intervals to a depth of 30 cm at five randomly-selected locations in order to estimate soil bulk density (g cm⁻³). A micrometer was used to determine the volume of each 5-cm section (~ 62 cm³). Soil samples were placed into pre-weighed tin cans

Effect of Swine Effluent Application Rate and Timing on Nitrogen Utilization and Residual Soil Nitrogen in Common Bermudagrass

Read, et al

and dried to a constant weight in an oven at 100 C. Values for bulk density were used to transform mass units for inorganic N to area units (kg ha⁻¹ N) for estimation of applied N remaining in soil in the different treatments.

Results and Discussion

Swine Effluent Analysis

The amount of effluent N applied in each treatment is presented in Table 2. Somewhat lower N provided in August-September 2000 was due to lower than average effluent N concentration. Effluent N existed primarily as NH₄-N (87% in 2000; 88% in 2001) with low percentage of NO₃-N (2.8% in 2000, and 1.5% in 2001). Total N in the effluent averaged about 65-76% of the values reported in a separate study (Adeli et al., 2003); however, values for total P are similar between the two studies. As a result, N/P ratio was lower than reported by Adeli et al. (2003) and averaged 3.72 in 2000 and 4.29 in 2001. Build up of soil P is predictable, because the N/P ratio of effluent is much lower than the ratio of N and P absorbed from the soil by bermudagrass (~4:1 vs. 10:1; Evers, 2002).

Forage Yield, Nitrogen Recovery, and Residual Soil Nitrogen

Averaged across the different spray seasons, doubling the effluent rate significantly increased forage DM yield by about 57% in 2000 and 24% in 2001 (Table 3). Relatively high yields in 2001 were likely related to greater monthly rainfall received during the growing season, May to October, as compared to 2000. Additionally, the total amount of N applied was somewhat greater in 2001 than 2000 (Table 2). Bermudagrass response to swine effluent has varied in different studies, and can be attributed to, among other things, difference in soil type (Adeli et al., 2006) or variety (Brink et al., 2003). In a study with 'Alicia' hybrid bermudagrass on Vaiden soil, Adeli et al. (2003) reported little advantage to N application rates exceeding 373 kg ha⁻¹. Our results suggest common bermudagrass irrigated with swine effluent can be as or more productive than Alicia bermudagrass when grown on Prentiss soil, as compared to either Vaiden or Okolona soil.

Due to increased DM yield, the amount of N recovered by bermudagrass was significantly greater at 20 cm ha⁻¹ than 10 cm ha⁻¹ (Table 3). But doubling the effluent rate did not lead to consistent changes in N utilization efficiency in the different spray seasons, as values for N efficiency relative to controls (100% efficient) were related inversely to the amount of N applied in 2000, but not in 2001. Doubling the effluent rate led to accumulations of NO₃-N in the surface soil, 0-20 cm depth (Fig. 3). At the recommended rate of 10 cm ha⁻¹, the soil contained about 40 kg N ha⁻¹ to 30-cm depth, or about 15% of the total N applied, and 36-75% was taken up and harvested with the forage across the different irrigation seasons. At 20 cm ha⁻¹ rate, the 0-30 cm soil depth contained just 10-12% of the total N applied, and 31-87% was taken up by bermudagrass. With regard to spray seasons, applying effluent in August-September resulted in significantly low values for forage DM yield and N recovery, and sometimes greater residual soil NO₃-N at either 0-5 cm or 5-10 cm depth.

In summary, bermudagrass yield, forage N concentration and apparent N recovery increased relative to unfertilized controls when effluent application preceded the harvest

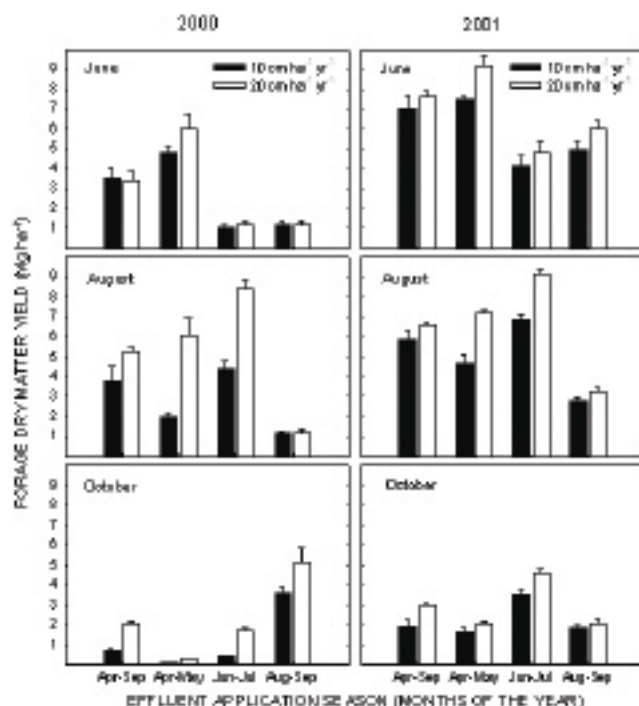

Figure 1. Treatment effects on yield of common bermudagrass forage by year and harvest.

Table 3. Forage dry matter (DM) yield, N uptake, and N utilization efficiency by common bermudagrass grown under rain-fed conditions (control) and irrigated with different rates of swine effluent in four application seasons in 2000 and 2001.

Effluent rate and spray season	DM yield		N recovery*		N efficiency	
	2000	2001	2000	2001	2000	2001
	Mg ha ⁻¹		kg ha ⁻¹		%	
Control	2.27	5.45	40.8	102.6	100	100
10 cm ha ⁻¹						
Apr - Sep	8.03	14.78	151.2	215.3	62.73	75.29
Apr - May	6.90	13.81	136.8	208.9	53.04	68.71
Jun - Jul	5.85	14.45	122.9	238.7	49.77	75.07
Aug - Sep	5.86	9.64	109.7	93.5	55.69	37.56
20 cm ha ⁻¹						
Apr - Sep	10.69	17.21	282.3	286.2	63.16	55.04
Apr - May	12.30	18.43	306.1	358.7	61.34	67.31
Jun - Jul	11.36	18.54	329.4	359.3	87.13	70.18
Aug - Sep	7.50	11.34	186.6	156.5	53.62	30.68
AOV Source [^]						
Rate	P<0.01	P<0.01	P<0.01	P<0.01	P<0.05	P<0.01
Season	P<0.01	P<0.01	P<0.01	P<0.01	NS	P<0.01
Rate x Season	NS [^]	NS	P<0.05	P<0.05	NS	NS
CV [^] , %	19.2	9.3	21.7	11.2	24.2	12.3
LSD [^] (Season)						
	1.71	1.43	46	28	15.33	7.65

* Apparent N recovery was calculated by subtracting N uptake by unfertilized (control) plots from that of each treatment in each replicate block; values presented are average annual N uptake of about 41 kg ha⁻¹ in 2000 and 103 kg ha⁻¹ in 2001. [^]AOV source, treatment variables analyzed statistically using analysis of variance; NS, not significant according to Fisher's F test at 5% level of probability; CV, coefficient of variation; LSD, least significant difference at 5% level of probability.

(Figs. 1 and 2). Annual forage yield and N utilization were somewhat lower in 2000 due to less rainfall and less N applied in effluent than in 2001. This difference was reflected in post season soils analysis, which found increased NO₃-N at 0-20 cm soil depth when 20 cm ha⁻¹ effluent was applied, particularly in August-September spray season, which had significantly more residual soil NO₃ in spring 2001 than other spray seasons (Fig. 3). The effect of effluent rate and timing on soil NO₃ was most apparent at 0-5 cm soil depth. With the exception of August-September spray season, for-

age N utilization increased as effluent rate increased from 10 to 20 cm. At 10 cm rate, the amount of effluent N not removed by bermudagrass was similar for all spray seasons.

Conclusions

Swine producers have interest in using effluent N efficiently without the associated risks to water quality that may arise from excessive or untimely applications of effluent N. The present study assessed the effect of irrigation rate and timing on N recovery by applying effluent to common

Effect of Swine Effluent Application Rate and Timing on Nitrogen Utilization and Residual Soil Nitrogen in Common Bermudagrass

Read, et al

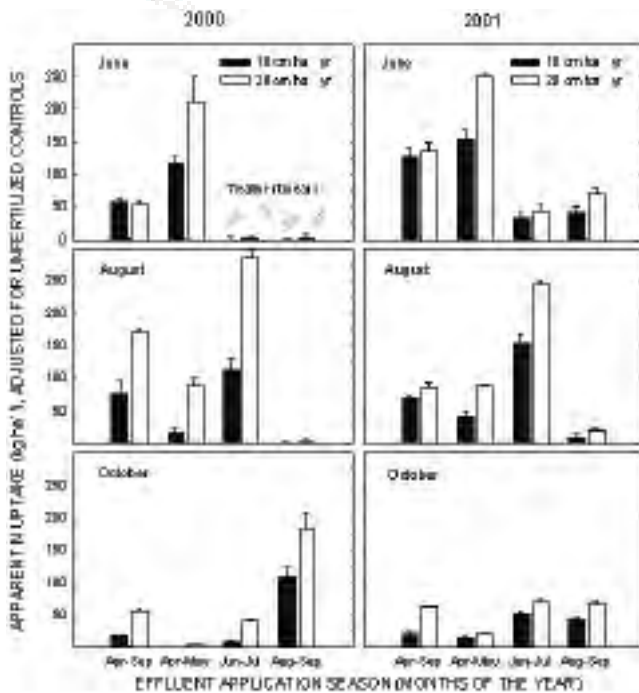

Figure 2. Treatment effects on nitrogen recovery in common bermudagrass by year and harvest.

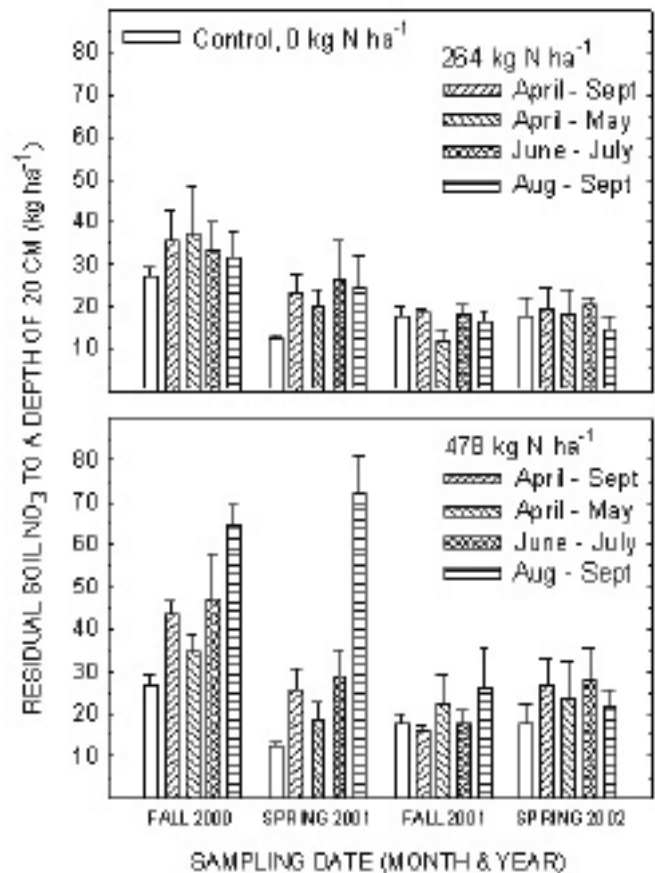

Figure 3. Effect of no irrigation (control) and four swine effluent spray seasons on the amount of residual soil nitrate to 20-cm depth in Prentiss sandy loam soil. Values represent the mean of four observations, and bars represent standard error of the mean.

bermudagrass from April to September (full season), as compared to shorter, 60-d periods during the growing season. Results indicate the risk of nitrate loss to the environment is increased when effluent application to bermudagrass is delayed until late in the growing season, particularly at higher application rates.

References

Adeli, A., J.J. Varco, and D.E. Rowe. 2003. Swine effluent irrigation rate and timing effects on bermudagrass growth, nitrogen and phosphorus utilization, and residual soil nitrogen. *J. Environ. Qual.* 32:681-686.

Adeli, A., D.E. Rowe, and J.J. Read. 2006. Effects of soil type on bermudagrass response to broiler litter application. *Agron. J.* 98:148-155.

Ball, D.M., C.S. Hoveland, and G.D. Lacefield. 1996. Southern forages. Potash and Phosphate. Inst., Norcross, GA.

Brink, G.E., D.E. Rowe, K.R. Sistani, and A. Adeli. 2003. Bermudagrass cultivar response to swine effluent application. *Agron. J.* 95:597-601.

Bremner, J.M. 1996. Nitrogen-total. p. 1085-1121. In D.L. Sparks et al. (ed.) *Methods of soil analysis, Part 3.* SSSA

POSTER SESSION

Book Series: 5. Soil Science Society of America and American Society of Agronomy, Madison, WI.

Burns, J.C., L.D. King, and P.W. Westerman. 1990. Long-term swine lagoon effluent application on 'Coastal' bermudagrass: I. Yield, quality, and elemental removal. *J. Environ. Qual.* 19:749-756.

Evers, G.W. 2002. Ryegrass-bermudagrass production and nutrient uptake when combining nitrogen fertilizer with broiler litter. *Agron. J.* 94: 905-910.

McLaughlin, M.R., K.R. Sistani, T.E. Fairbrother, and D.E. Rowe. 2005. Overseeding common bermudagrass with cool-season annuals to increase hay yield and N and P uptake in a swine effluent spray field. *Agron. J.* 97:487-493.

Mehlich, A. 1984. Mehlich 3 soil test extractant: A modification of Mehlich 2 extractant. *Commun. Soil Sci. Plant Anal.* 15:1409-1416.

Mississippi Natural Resources Conservation Service. 2000. Waste Treatment Lagoon. Code 359. Field Office Tech. Guide Section IV. Mississippi NRCS, Jackson MS.

Mulvaney, R. L. 1996. Nitrogen-Inorganic Forms. p. 1123-1131. In D.L. Sparks et al. (ed.) *Methods of soil analysis, Part 3*. SSSA Book Series: 5. Soil Science Society of America and American Society of Agronomy, Madison, WI.

Read, J.J. G.E. Brink, J.L. Oldham, W.L. Kingery, and K.R. Sistani. 2006. Effects of broiler litter and nitrogen fertilization on uptake of major nutrients by Coastal bermudagrass. *Agron. J.* 98:1065 1072.

Rowe, D.E., T.E. Fairbrother, and K.A. Sistani. 2006. Winter cover crop and management effects on summer and annual nutrient yields. *Agron. J.* 98:946-950.

Welsh, R., and B. Hubbell. 1999. Contract hog production and environmental management in the southern United States. *Agron. J.* 91: 883-888.

POSTER SESSION

Conservation planning for fish assemblages based on land cover distribution

Peter E. Schweizer and Glenn R. Matlack
Environmental and Plant Biology
Ohio University
Porter Hall 405
Athens, OH 45701
740-593-1131
Email: ps128502@ohio.edu

ABSTRACT

Landscape dynamics over various spatial scales are integrated by fish assemblage composition. We examined species diversity and abundance pattern of fish assemblages from 27 selected headwater or low-order outer coastal plain streams near Hattiesburg, Mississippi. Non-metric multidimensional scaling (NMDS) identified measures of fish assemblage composition which best described assemblage differences based on richness, diversity and species dominance. Assemblages varied in composition by feeding preference, water column position of dominant species, and tolerance to increased water temperature and silt or sediment deposition. Observed assemblage compositions are likely the result of synergistic processes with nested relationships between landscape structure, land cover, and spatial distribution of land cover. Mosquito fish and sunfishes were the most abundant species in urbanized catchments while minnows, darters, and madtoms contributed to larger species diversity in rural and forested watersheds. Rural and forested catchments with stable land cover exhibited the largest fish species diversity. Results of this study contribute to our understanding of how spatial distribution of land cover influences watershed health as measured by water quality, stream geomorphology, and fish assemblages as biotic indicators of watershed condition, and identified sensitive areas and land cover with potential negative impacts on biotic diversity for consideration of conservation planning.

Keywords: Conservation, ecology, water quality, surface water

POSTER SESSION

Real-Time Pier Scour Monitoring on the Pascagoula River at Interstate 10

John Storm
USGS Mississippi Water Science Center
308 South Airport Road
Jackson, MS 39208
601-933-2951
Email: jbstorm@usgs.gov

ABSTRACT

Scour at bridge piers located within a stream channel or floodplain is a major cause of bridge failure. Erodeable sediment can be degraded away from a bridge pier during a flood to the point where the pier is undermined and failure is imminent. Laboratory models and field analyses have been used to quantify the components of scour. The three basic components include:

- 1) Local scour: erosion caused by local disturbances in the flow. This can be caused by build-up of debris on the pier, or the vortices that naturally are produced by the pier.
- 2) Contraction scour: erosion caused by the increased flow velocities as the approach flow is forced through the reduced area of the bridge opening.
- 3) General scour: erosion that naturally occurs in a channel even when there is no bridge present.

The U.S. Geological Survey, in cooperation with the Mississippi Department of Transportation, has installed a real-time scour monitoring gage at a pier bent on the east-bound bridge at the U.S. Interstate 10 crossing of the Pascagoula River. The gage records both stream stage and channel-bed elevation at 15-minute intervals. The channel-bed is monitored using in-situ transducers at the upstream and downstream sides of the pier bent. Data are transmitted hourly via the Geostationary Operational Environmental Satellite, stored in a local database, and made available to the public at the following web site:

<http://ms.water.usgs.gov>

The objective of this gage is to monitor scour effects over time on a near instantaneous interval at a bridge pier that has been subjected to past scour problems, resulting in the loss of as much as 20 feet of penetration since the bridge was completed in 1975.

Keywords: Floods, Models, Sediments

DELTA GROUNDWATER



Agricultural Water Use in the Mississippi Delta

Shane Powers
Yazoo Mississippi Delta Joint Water Management District

Determining Potential for Direct Recharge in the Mississippi River Valley Alluvial Aquifer Using Soil Core Analyses, Washington County, Northwestern Mississippi

Claire E. Rose
Millsaps College

Changes in Water Volume in the Mississippi River Valley Alluvial Aquifer in Northwest Mississippi

Mark Stiles and Dean Pennington
YMD Joint Water Management District

Potential for Infiltration through the Fine-grained Surficial Deposits of the Bogue Phalia Watershed, Mississippi

Patrick C. Mills, Jeannie R. Bryson, Claire E. Rose, and Richard H. Coupe
U.S. Geological Survey, Illinois Water Science Center

Mississippi River Valley Alluvial Aquifer Geology of the Central Delta (East Central Sunflower County and West Central Leflore County)

Charlotte Bryant Byrd
Office of Land and Water Resources

Mississippi River Floodplain "Delta" - Bluff Margin Alluvial Fan Complexes

James E. Starnes and John C. Marble
Mississippi Office of Geology, Mississippi Department of Environmental Quality

DELTA GROUNDWATER

Agricultural Water Use in the Mississippi Delta

Shane Powers
Yazoo Mississippi Delta Joint Water Management District
P.O. Box 129
Stoneville, MS 38776
Phone: (662)902-2634
Email: shane@ymd.org

ABSTRACT

Agricultural water use from the Mississippi River Valley Alluvial Aquifer exceeds long term recharge rates and is resulting in declines of aquifer water levels. Understanding agricultural water use is essential to developing plans to reduce groundwater use to match the long term recharge of the aquifer. This paper reports the amount of ground water pumped on to the major crop types and the irrigation methods of the Mississippi Delta. Water use numbers have been gathered by YMD staff over the past 15 years in an effort to determine annual water use per acre. Major crop types studied include: Cotton, corn, soybeans, rice and catfish. Water used on individual sites is determined by obtaining flow rates for each well in the study, then determining each well's time of operation. By multiplying the flow rate by the time the wells ran, the amount of water pumped can be obtained. Field size is determined through the use of aerial photos and site inspection. The total water pumped is then divided by the acres receiving water to get water used per acre. Irrigation methods are recorded for each site. Different irrigation methods observed include pivot, furrow, contour levee, straight levee, straight levee multiple inlets, and zero grade. The per acre water use numbers are shown in three different ways: 1.) Annual water use across all crop types, 2.) Average water use per acre for each crop type, 3) Where it is relevant, water use per crop type by different irrigation methods. In 2006 results showed cotton use an average of .84 acre feet per acre over the course of the growing season. Soybeans used an average of 1.00 acre feet per acre, corn used an average of 1.16 acre feet per acre, catfish used an average of 2.40 acre feet per acre, and rice used an average of 3.34 acre feet per acre. These numbers represent the highest amount water used since 2000.

Keywords: Agriculture, Ground Water, Water Use

Introduction

Agricultural water use from the Mississippi River Valley Alluvial Aquifer currently exceeds long term recharge rates and is resulting in declines in aquifer levels across the Delta. Understanding agricultural groundwater use is essential to the development and implementation of plans aimed at reducing groundwater use to levels matching that of the long term recharge rate of the aquifer. In an effort to better understand irrigation requirements of the different crops of the Delta, YMD conducts a water use survey throughout each growing season. This survey is designed to reveal the

amount of groundwater used per acre on Delta crops.

YMD's Annual Water Use Survey was started in 1991 as a means of determining the amount of groundwater used per acre on catfish farms in the Delta. The original survey consisted of twelve sites all of which were located in Humphreys, Leflore, and Tunica counties. The Water Use Survey's focus remained on catfish groundwater use until 1994 at which time it was expanded to encompass rice and row crops as well as catfish.

While the basic goals of the Water Use Survey have remained the same, over the years, data collection and

analysis techniques have continually evolved. This evolution has allowed YMD to generate more accurate and useful groundwater use numbers each year. While early surveys included only a minimal number of sites, with a focus on catfish, more recent surveys have grown to include well over 100 sites focusing on all the major crop types of the Delta. Sites now range from the Mississippi River to the West, to Leflore County in the east, south to Yazoo County, North to Tunica County and all areas between. Through this layout, results are influenced less by localized rainfall events and are more representative of the Delta as a whole.

Survey sites are currently broken down and compared based on crop type as well as the irrigation methods used on each site. This analysis reveals the most water efficient methods of irrigating each crop. These groundwater use numbers play a vital role in the planning and implementation of water efficient management practices across the Mississippi Delta. By implementing these practices groundwater withdraws can be reduced to levels more closely matching the recharge rate of the aquifer, thereby cutting our overdraft significantly.

Purpose and Scope

The purpose of this study is to determine the amount of irrigation water applied to the crops grown in the Mississippi Delta and to reveal the most water efficient means of irrigating each crop. Crops included in the study are cotton, corn, soybeans, rice, and catfish. Early groundwater use numbers were divided into three primary categories: Rice, row crops, and catfish, but subsequent groundwater use numbers are divided into the five distinct categories breaking row crops down to cotton, corn, and soybeans.

Along with groundwater applied per crop type, the groundwater applied for each irrigation method under specific crop types is also recorded and compared. Irrigation methods and land contours observed in the study include zero grade, multiple inlet, straight levee, and contour levee irrigation for rice sites. Furrow, straight levee, and contour levee irrigation were used for soybean irrigation. Furrow and pivot irrigation were used for cotton irrigation, and furrow irrigation was used for corn irrigation. Each of the irrigation methods represents different groundwater use characteris-

tics among individual crop types, some of which use more groundwater while others use significantly less.

Methodology

Site Selection

The first step in each survey is site selection. Each year sites are added in an effort to generate more accurate and representative numbers. Typically the survey begins with between 250 and 300 sites, but through equipment failure, supplemental irrigation, or meter removals and changes the number falls to between 100 and 150 by the season's end. Sites are selected at random across the Delta based on three primary factors: Accessibility, availability of a dedicated utility meter, and crop type (when evident).

Sites must be accessible for YMD staff, meaning wells behind lockable gates or across low lying fields are generally kept out of the survey. Also sites close to growers' headquarters are kept to a minimum because YMD's influence on the irrigation practices of those growers is likely to increase as contact with the growers increases. Electric wells are the primary wells observed in this study. This is because their utility meters are a simple and effective way to keep up with their run time. If the electric well lacks a dedicated utility meter it will not be used unless a time totalizer is installed. Due to totalizer failure this is not a viable option for the majority of survey sites. Lastly crop type may be used in site selection late in the planting season in order to elevate numbers of a certain crop that may have been of a smaller sample size compared to the other crops.

Runtime Measures

Once sites have been selected, an initial reading is taken from either the utility meter running the pumping mechanism of the well, or a time totalizer installed by YMD staff before the irrigation season begins. After the initial reading, readings are taken at the end of every month throughout the growing season in order to get a monthly groundwater use number. A final reading is then taken at the end of the season in order to get the total kilowatts used on the electric wells and the total hours of operation displayed on the time totalizers.

DELTA GROUNDWATER

Kilowatts used per hour are figured during the growing season while the well is running. This figure is obtained by taking a reading while the well is running and recording this number down to the smallest practical unit of measure (hour/minute/seconds), then returning between 3 and 24 hours later to record a second measurement. The number of units used can then be divided by the elapsed time to give kilowatt usage per hour. This figure can then be used to figure hours of operation by dividing total kilowatts used by the kilowatts used per hour by the well. The time totalizers are mounted on diesel wells or electric wells lacking a dedicated utility meter. These devices calculate the total hours of operation by monitoring vibrations made while the wells are operating. The hours are then displayed on a LED screen negating the need for any further calculation in order to obtain total hours of operation.

Flow Rates

The flow rate of each well is measured during the growing season; this is done through the use of an ultrasonic flow meter. Flow meter sensors are attached to the outside of the pipe wall and use ultra sonic waves along with manually entered pipe parameters in order to calculate flow. Flow rates are recorded in gallons per minute and later are converted to gallons per hour to be used in groundwater use calculations. The ultrasonic flow meter is noninvasive meaning it is mounted to the outside of the pipe wall and does not inhibit flow in any way. The gallons pumped per hour can then be multiplied by the hours of operation to get the gallons pumped from the well. A Cross-Correlation flow meter was used for the 1991 and select sites for the 1992 survey. However ultra sonic flow meters were used to determine how many gallons per minute each groundwater well pumped from the 1992 survey until the present. Ultrasonic models used include a Tyme-Flyte portable flow meter, a Controtron 1010 portable flow meter, and most recently a Fuji Ultrasonic Portaflow flow meter.

Acreage Calculation

Acreage receiving the water can be determined through three primary methods: Through the use of YMD's GIS

database, physical land inspection, or through grower consultation. Most common is a combination of the GIS database information accompanied by physical inspection. Growers are only contacted if riser placement is ambiguous or supplementary irrigation from a surface water source or other groundwater well look likely. Gallons pumped are then divided by irrigated acres in order to get the gallons used per acre. This number is then divided by 325,900 to get the acre feet used per acre on each site. The per acre groundwater use numbers are displayed in three different ways: 1.) Annual average groundwater used across all crop types studied, 2.) Average groundwater used for each crop type studied, 3.) Where it is relevant, groundwater used per crop type by different irrigation methods.

Equations

Utility Meter Method

1. Flow Rate (GPM) X 60= Gallons Per Hour (GPH)
2. Total utility meter units / Utility meter rate (unit/unit per hour) = Total Hours of Operation
3. Total Hours of Operation x GPH= Total Gallons Used
4. Total Gallons Used / Acres Irrigated = Gallons Per Acre (GPA)
5. GPA / 325,900 (gallons per acre foot) = Total Acre Feet of Water Used Per Acre

Time Totalizer Method

1. Flow Rate (GPM) X 60= Gallons Per Hour (GPH)
2. Total Hours of Operation x GPH= Total Gallons Used
3. Total Gallons Used / Acres Irrigated = Gallons Per Acre (GPA)
4. GPA / 325,900 (gallons per acre foot) = Total Acre Feet of Water Used Per Acre

Table 1. Average acre feet of groundwater applied per acre per crop type.

Year	Catfish	Row Crops	Rice	Cotton	Corn	Soybeans	Yearly Average
1991	2.1						2.1
1992	1.8						1.8
1993	2.1						2.1
1994		1.0	3.0				2.0
1995		1.1	3.5				2.3
1996		0.7	2.5				1.6
1997		1.0	3.0				2.0
1998		1.1	3.5				2.3
1999		1.0	3.3	0.6	0.9	1.4	1.6
2000		1.2	3.6	0.7	1.2	1.6	1.8
2001							
2002		0.7	3.1	0.5	0.9	0.7	1.3
2003		0.6	2.7	0.5	0.6	0.6	1.1
2004	1.5	0.4	2.5	0.3	0.4	0.4	0.9
2005		0.7	3.0	0.5	1.0	0.6	1.3
2006	2.4	1.0	3.3	0.8	1.2	1.0	1.6
Average	2.0	0.9	3.1	0.6	0.9	0.9	1.4

Results

Yearly groundwater application (use) averages for individual crop types ranged from a high of 3.6 acre-feet per acre for rice during the 2000 growing season to a low of 0.3 acre feet per acre for cotton during the 2004 growing season. Average groundwater applied per crop type across all of the years included in the survey ranged from 3.1 acre feet per acre in rice to 0.6 acre feet per acre in cotton (Table 1).

Irrigation method analysis revealed that pivot irrigation was the most water efficient way to irrigate cotton, straight levee flooding was the most water efficient way to irrigate soybeans, and zero grade irrigation was the most water efficient means to irrigate rice (table 2). The differences in row crop irrigation practices show less of an impact on their irrigation groundwater use characteristics than do the differences in rice irrigation. The 2006 survey highlighted the fact that a well managed multiple inlet site can approach the

water efficiency of a zero grade field without the problems associated with zero grade land forming.

The 2006 Water Use Survey compared the groundwater use of catfish farmers receiving EQIP funds to practice the 6/3 method of water conservation with the groundwater use of farms not receiving funding. It was found that the groundwater use of both parties was nearly identical. Better educated farmers along with skyrocketing energy costs are thought to be the key reasons for the water use similarities. EQIP farms applied an average of 2.5 acre feet per acre, while farms not receiving EQIP funds applied 2.2 acre feet of groundwater per acre (table 3). It should also be noted that there were only seven sample sites compared in catfish water use, and numbers could have been influenced by localized rain events.

Differences in the irrigation groundwater use of individual row crops in the Delta have been shown to remain similar regardless of irrigation method. Rice, however, has shown

DELTA GROUNDWATER

Table 2. Average acre feet applied per acre for different irrigation methods 2004-2006.

	Furrow	Pivot	Contour	Straight Levee	Multiple Inlet	Zero Grade
Cotton	0.7	0.5				
Corn						
Soybeans	0.9		0.9	0.8		
Rice			3.8	3.1	2.3	1.6

greater irrigation groundwater use differences among the irrigation methods used. Therefore, the widespread implementation of more water efficient irrigation practices in rice production represents a promising opportunity to generate groundwater savings. Savings of only one acre foot per acre in rice irrigation could save the aquifer nearly 250,000 acre feet of water per year. This savings would approach the average overdraft and help to bring groundwater withdrawals closer to the recharge rate of the aquifer.

Table 3. Catfish average acre feet applied per acre 2006.

EQIP	Non-EQIP
2.5	2.2

DELTA GROUNDWATER

Determining Potential for Direct Recharge in the Mississippi River Valley Alluvial Aquifer Using Soil Core Analyses, Washington County, Northwestern Mississippi

Claire E. Rose
USGS Mississippi Water Science Center
Millsaps College
308 South Airport Road
Jackson, MS 39208
601-933-2976
Email: cerose@usgs.gov

ABSTRACT

In 2005, the U.S. Geological Survey National Water-Quality Assessment program selected a site in the Bogue Phalia Basin for a study involving the sources, transport, and fate of agricultural chemicals. Because of its unique natural features, which include rich soils and an ample water supply, the basin is an ideal setting for agricultural activities, making it an area heavy in application of agricultural chemicals. In 2006, the U.S. Geological Survey began study at a site in Washington County, Mississippi. The objective of the study was to assess the potential for water and agricultural chemical transport to the Mississippi River alluvial aquifer by interaction with surface water and recharge from precipitation.

Previous water-quality and flow system studies of the Mississippi River alluvial aquifer in northwestern Mississippi, locally referred to as the "Delta", have given rise to the questions about the effect and magnitude of the vertical recharge component of the flow system. Some models have indicated that rainfall is the single largest contributor to recharge of the alluvial aquifer, which is a surprising result given the dense clay soils overlaying the aquifer. In the topostratum of an agricultural field adjacent to the Bogue Phalia near Leland, soil cores were collected during installation of four shallow wells (all less than 24 feet deep). The soil cores were analyzed for bulk density, grain size distribution, and permeability. Hydraulic conductivity was estimated using three methods: (1) a falling head permeameter to determine vertical hydraulic conductivity; (2) the Rosetta Stone program, which uses bulk density and grain size values to model hydraulic conductivity values; and (3) the Hazen method, which uses effective grain size and sorting of the soil to determine empirically the hydraulic conductivity. The resulting data indicate that the upper 8 feet of topostratum consists of a clay loam with vertical hydraulic conductivity values ranging from 10^{-5} to as low as 10^{-7} centimeters per second. The interval from 10 to about 16 feet was a sandy loam with hydraulic conductivity values ranging from 10^{-3} to 10^{-4} centimeters per second. The data and the relatively homogenous and continuous blanket of lower permeability clay loam suggest that the potential for vertical recharge is low. However, appreciable lateral recharge from the Bogue Phalia is likely as the river incises the clay loam to the higher conductivity fine, sandy loam interval.

Keywords: Agriculture, Ground Water, Hydrology, Sediments, Surface Water

Introduction

The Delta, a 7,000-square-mile area of the Mississippi River alluvial plain in northwestern Mississippi, is underlain by the Mississippi River alluvial aquifer. This aquifer is the most heavily pumped in the state and is the sole source aquifer for agricultural and industrial water. The hydrology of the alluvial aquifer has been defined extensively by Arthur

(2001), Boswell and others (1968) and Snider and Sanford (1981).

Arthur (2001) used MODFLOW, a modular 3D finite-difference ground-water flow model, to study the flow system of the alluvial aquifer. Arthur reported that the most important source of vertical recharge to the alluvial aquifer is precipitation, which is surprising because it is seemingly incongruent

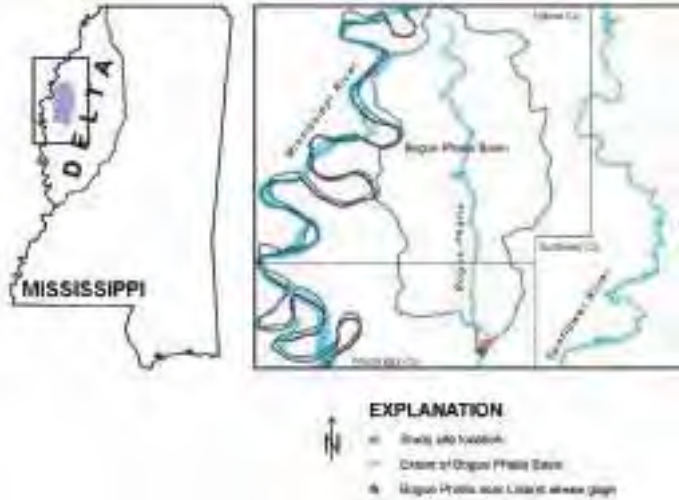

Figure 1. Location of Bogue Phalia Basin in the Delta of northwestern Mississippi.

with the lithology of the Delta. Additional study is needed in the Delta to better understand the magnitude and distribution of recharge from rainfall (Arthur, 2001).

In 2001, the U.S. Geological Survey's National Water-Quality Assessment (NAWQA) Program began studies in five agricultural basins within the United States to better understand how the transport and fate of water and agricultural chemicals is affected by natural factors and agricultural management practices. Assessments of two more basins began in 2005, including the Bogue Phalia Basin in northwestern Mississippi (fig. 1), which was selected because of its unique natural features.

The need to further define the source of vertical recharge to the alluvial aquifer prompted a study to identify the types of soil and assess soil permeability in the basin. In 2006 a site was selected in an agricultural field along the Bogue Phalia, east of Leland, Washington County, Mississippi, to investigate the potential for water and agricultural chemical transport to the alluvial aquifer.

This paper presents the results of an investigation into the mechanisms and pathways of water transportation through the unconsolidated soils overlying the Mississippi River alluvial aquifer in the Bogue Phalia Basin by determining the saturated vertical and empirical hydraulic conductivity values of the different soil types overlying the aquifer. In the study



Figure 2. Aerial view of Bogue Phalia study site and location of the vertically nested well pairs.

area, four shallow wells were installed in two agricultural fields on the banks of the Bogue Phalia.

Study Area

The study area, identified as "Bogue Phalia at Highway 82, Fratesi Boat Ramp," is located in a soybean field in the Bogue Phalia Basin, east of Leland, Mississippi. The field is adjacent to U.S. Highway 82, and the Bogue Phalia divides the field into two separate parcels of land (fig. 2). A public boat ramp is located on the west side of the Bogue Phalia.

The study site contains rich floodplain soils and an ample water supply. The average rainfall for Washington County is 52 inches annually, which makes for an ideal agricultural setting (Taylor and others, 1971), and an area in which agricultural chemicals are heavily used. Agricultural chemicals have been detected recurrently in surface water and rainfall in this area since the 1990s (Coupe and Capel, 2005). An earlier study on the Bogue Phalia indicated the presence of many herbicides. (Coupe, 2000).

Data Collection and Analysis

In March 2006, vertically nested shallow wells were installed, oriented in an east-west axis, which is assumed to be the direction of regional ground-water flow. Four shallow wells were installed with a Geoprobe, a direct-push hydro-

DELTA GROUNDWATER

Determining Potential for Direct Recharge in the Mississippi River Valley Alluvial Aquifer Using Soil Core Analyses, Washington County, Northwestern Mississippi

Rose

lic-sampling device. The wells were cased and instrumented to collect temperature and water-level data. Water levels ranged from a depth of 17.5 to 18.5 feet below land surface. Eighteen soil cores, 4-foot by approximately 2-inches, were collected using the Geoprobe. The Geoprobe allowed for the soil to be extracted in cylinders, making it possible to analyze the soil by depth because each core was representative of a small section of the soil stratum. As cores were extracted, they were collected in plastic tubes, which were then enclosed with rubber caps and sealed with electrical tape to retain the in-situ water for soil moisture data analysis. At the site, the soil type and interval change were recorded on the core tube with permanent marker. Subsequently, data sheets were completed in the field to document the depth to which the wells were drilled, what material was encountered and at what depths, and to what interval the wells were screened. Any use of trade, product, or firm names is for identification purposes only and does not constitute endorsement by the U.S. Government.

The collected soil cores were analyzed for permeability, bulk density, and grain size distribution during summer 2006. The first step in analyzing the cores was to differentiate each soil type by depth. A first assessment was done as the cores were extracted from the ground; but, to improve accuracy, the cores were visually and texturally analyzed further to note any subtle grain size changes or distribution that might have been overlooked while in the field. This assessment was performed in the laboratory using the methods described by the USDA in their Soil Texturing Field Flow Chart (Midwest Geosciences Group, 2001). The USDA Texturing Field Flow chart identifies soils based on the feel of the soil material, its grittiness when wet, and its cohesiveness, or propensity to roll into a ball and produce a ribbon when squeezed. Values for hydraulic conductivity (K) were obtained directly using a falling head permeameter (FHP) test (Raynolds and others, 2001) and modeled by the Rosetta Model (Rosetta Model, 1999) using bulk density values and grain size percentages, which were obtained using the Pipette method of grain size distribution (Hall, undated). The grain size distribution data were used to determine the empirical K from the Hazen method (Fetter, 2001).

Analytical Methods

Methods used to analyze the data include the falling head permeameter to determine K, the Rosetta Model to determine K, and the Hazen method to determine K. The Pipette method was used to determine grain size distribution, and X-Ray diffraction was used to identify the clay minerals.

Bulk Density

For bulk density, the samples were extracted so that the exact volume of the soil was known. In some cases, when possible, remaining sections of core that were tested in the permeameter were used, because the volume of soil could be calculated from the equation for the volume of a cylinder. The samples were then dried in a laboratory oven for 48 hours, and weighed. The bulk density is equal to the dry weight of the sample divided by the volume of the sample (Hall, undated).

Pipette Method of Grain Size Distribution

After the sections of core were taken for the permeameter, samples from each soil type were then taken to determine grain size distribution. The samples for the grain size distribution were analyzed using the Pipette method of grain size distribution by weight percentage (Hall accessed July 2006). Each test used a 20-gram sample from each soil type that was sieved through 0.90-, 1.17-, 2.29-, 7.62-, and 10.16-millimeter openings.

The dry weight retained for each grain size was determined using the Pipette method, (Hall, accessed July 2006) and those values were used to calculate the grain size percentage of each sample. Grain size distribution curves were then plotted from the percentage data and were used to determine the d_{10} (the grain size that is 10 percent finer by weight) and d_{60} (the grain size that is 60 percent finer by weight) values, which were used for the Hazen method.

Falling Head Permeameter

The falling head permeameter (FHP) method was determined to be the better testing method rather than the constant head permeameter method, because the sample material was primarily unconsolidated, non-granular soils.

DELTA GROUNDWATER

The procedure for the falling head permeameter was adapted from Reynolds and others (2001). The equation used to calculate the K values from the falling head permeameter test is as follows:

$$K = aL/At(\ln h_0/h_1), \quad (1)$$

where:

K equals hydraulic conductivity in centimeters per second;

a equals the area of the manometer (the tube through which the water is transported to the core);

A equals the sample area;

h_0 equals initial head;

h_1 equals the final head;

L equals the sample length; and

t equals time.

Cores were first selected for the FHP test based on the cohesiveness and homogeneity of the sediment in each section. Sections of core, 6 centimeters long, were removed from each soil type to test in the permeameters. Each section of core had to contain enough clay or silt to hold it together during the testing. The permeameter test was modified from Reynolds and others (2001) to adjust for the soil type that was collected from the study area. Because the soil sections were smaller in diameter than most permeameters have the capacity to test, a specialized falling head permeameter was built. Using Reynolds and others (2001) as a model and using common hardware store supplies, a modified falling head permeameter was successfully built.

After extracting the soil section, the exact dimensions of the cylinder of soil were measured, and the section was encased in paraffin wax before any evaporation occurred and to ensure that no shrinkage of the core occurred. Before encasing, the core was inspected for any surface features that might cause preferential flow during testing. Nearly half of all sections that were to be tested had vertical, shallow gouges down the length of the section caused by the plastic "rabbit" used by the Geoprobe during extraction of the cores from

the subsurface. To prevent water from running through the grooves, a razor knife was used to slice horizontal grooves into the outside of the cylinder of soil. These cuts were made slightly deeper than the vertical gouges. The carved grooves captured the wax and prevented water from running down between the wall of the core and the wax.

After the permeameter test was completed, the encased section of soil was saturated with a blue dye solution to test for flow on the outside of the core. The dye would, theoretically, travel the same paths that the water traveled through the core. Then the core was cut from its encasement and inspected for blue areas around the surface of the core and on the inside of the wax casing. The test was complete unless evidence of preferential flow was found. If blue dye was visible on the outside of the soil core, another section of the same soil type was tested again. The head values and recorded times, along with the dimensions of the core and manometer, were used in a formula that gave the K value in centimeters per second.

Hazen Method

The Hazen method of grain size analysis is empirically based. The method uses the effective grain size and the sorting of the soil to determine the K.

The equation used to determine the K for the Hazen method is as follows:

$$K = C(d_{10})^2, \quad (2)$$

where:

K is hydraulic conductivity in centimeters per second;

d_{10} is the effective grain size in centimeters; and

C is a coefficient based on grain size and correlated values.

Very fine, poorly sorted sand has a C coefficient ranging in value from 40 to 80. The C coefficient for fine sand with appreciable fines ranges from 40 to 80. Medium, well-sorted sand has a coefficient that ranges from 80 to 120. Coarse, poorly sorted sand has a C coefficient that ranges

Determining Potential for Direct Recharge in the Mississippi River Valley Alluvial Aquifer Using Soil Core Analyses, Washington County, Northwestern Mississippi

Rose

from 80 to 120, and clean, coarse, well-sorted sand has a C coefficient that ranges from 120 to 150 (Fetter, 2001). The d10 value is derived from the grain size distribution curve plotted for each sample.

Rosetta Model

The Rosetta Model is an empirically-based method for determining the hydraulic conductivity. The Rosetta Model is a computer program that uses bulk density values and sand, silt, and clay percentages as input to derive a value for hydraulic conductivity (Rosetta Model, 1999).

X-Ray Diffraction

To determine the clay mineralogy of the soil, representative samples were scanned on a Scintag XDS 2000 diffractometer. Approximately 1 gram of powdered soil was placed in a centrifuge tube filled with water. Following agitation, the sample was placed for 10 seconds in a centrifuge to remove higher specific gravity minerals. The supernatant fluid was drawn off into a separate tube and centrifuged again for 20 minutes. The sediment at the bottom of the centrifuge tube was re-suspended in a small amount of water and deposited on a glass slide with a pipette and permitted to dry. All slurry-mounted samples were scanned. Expandable layer clays were detected by an increase in the d-spacing after exposing the slides to ethylene glycol vapors overnight. The final scans were done after heating the slides to 400° C and again after heating to 550° C to destroy heat sensitive clays (Starkey and others, 1984).

Results

The sand percentage found above the 10-foot depth for all wells ranges from 4.1 to 18.2 percent, with an average of 11.6 percent. A significant increase in the sand percentage occurs below the 10-foot depth. The sand percentage from below the 10-foot depth for all wells ranges from 20.8 percent to 99.6 percent (table 1). The average sand percentage below the 10-foot depth for all wells is 75.8 percent. The bulk density data indicate a similar shift at the same depth interval (fig. 3).

There is an apparent change in the bulk density values of the soil above and below the 10-foot depth (fig. 3). There is a transitional area in the 10-foot depth zone in which the sediments transition from a silty loam to a fine sandy loam (table 1). In looking at the different lithologies, there is a notable close range of bulk density values for each soil type, and there is also a notable shift in bulk density below 10 feet. The bulk density values decrease with depth due to increase in percentage of sand. These values indicate that the soil porosity increases with depth. One might expect K to increase as the bulk density values decrease. The range of bulk density values above the 10-foot depth is about 1.7 to 2.2 grams per cubic centimeter, with an average bulk density value of about 2.0 grams per cubic centimeter. The range of bulk density values below the 10-foot depth, but above the 17-foot depth is lower, from about 1.2 to 1.7 grams per cubic centimeter with an average bulk density value of 1.36 grams per cubic centimeter. As the depth reaches 17 and 19 feet, and as the soil begins to include larger-grained sand, the bulk density values are on the higher end of the range for the fine sandy loams above (between 1.36 and 1.70 grams per cubic centimeter) with an average bulk density value of 1.51 grams per cubic centimeter (fig. 3).

Figure 4 shows how the three different methods used to obtain hydraulic conductivity relate. Because the FHP (falling head permeameter) could test only the shallower sections of the wells, and the Hazen method could be used only on the

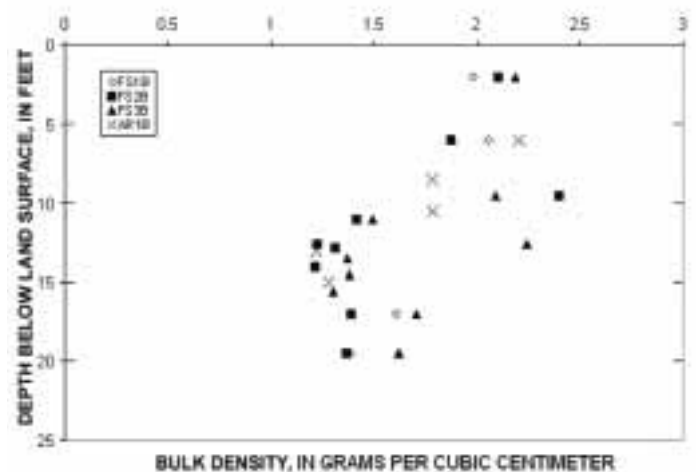

Figure 3. Bulk density by depth at four well locations at the study site.

Table 1. Hydraulic conductivity values as estimated by falling head permeameters (Raynolds and others, 2001), Rosetta (Rosetta Model, 1999), and Hazen methods (Fetter, 2001), and the silt, sand, and clay percentages determined using the Pipette method of grain size distribution for four shallow wells at the study site.

[ft, feet; cm/s, centimeters per second; N/A, not applicable]

Well	Depth (ft)	Kz Per-meameter (cm/s)	Rosetta k cm/s	Hazen k cm/s	Percent Sand	Percent Silt	Percent Clay
FS1B	2.0	7.11E-06	2.39E-04	N/A	11.8	88.2	0.00
FS1B	8.00 - 10.00	Soil cores not recoverable					
FS1B	6.00	no flow after 24 hours	2.00E-04	N/A	10.6	89.4	0.00
FS1B	17.0	N/A	8.62E-04	5.76E-03	99.6	0.30	0.15
FS1B	19.5	N/A	8.88E-04	4.00E-03	99.6	0.35	0.05
FS2B	2.00	7.80E-05	7.17E-05	N/A	4.1	87.2	8.70
FS2B	6.00	no flow after 24 hours	1.94E-04	N/A	11.0	79.3	9.64
FS2B	9.50	6.45E-06	8.41E-06	N/A	12.1	81.6	6.36
FS2B	11.0	N/A	6.34E-04	1.00E-03	80.0	20.1	0.00
FS2B	12.6	N/A	5.50E-04	N/A	26.9	67.0	6.17
FS2B	12.8	N/A	5.16E-04	1.96E-03	81.1	18.2	0.72
FS2B	14.0	N/A	8.41E-04	4.00E-03	96.4	3.34	0.27
FS2B	17.0	N/A	8.86E-04	4.84E-03	99.4	0.60	0.00
FS2B	19.5	N/A	6.36E-04	2.25E-03	79.9	17.5	2.64
FS3B	2.00	1.73E-05	7.25E-05	N/A	14.0	78.7	7.32
FS3B	6.00	no flow after 24 hours	2.97E-04	N/A	14.4	82.6	0.00
FS3B	9.50	1.71E-05	1.09E-04	N/A	8.8	84.3	6.90
FS3B	12.6	N/A	5.83E-05	N/A	20.8	72.3	6.91
FS3B	12.8	N/A	5.16E-04	1.96E-03	81.1	18.2	0.72
FS3B	13.5	N/A	8.79E-04	6.76E-03	99.0	0.76	0.29
FS3B	14.5	N/A	8.47E-04	4.00E-03	96.7	2.21	1.11
FS3B	17.0	N/A	6.15E-04	2.89E-03	88.3	7.79	3.90
AR1B	6.00	5.86E-07	4.73E-05	N/A	11.6	79.6	8.80
AR1B	8.50	5.82E-07	2.65E-04	N/A	18.2	74.2	7.68
AR1B	10.5	N/A	2.65E-04	N/A	26.1	66.3	7.64
AR1B	13.0	N/A	7.61E-04	2.25E-03	88.6	11.4	0.00
AR1B	15.0	N/A	5.62E-04	6.40E-04	51.0	49.0	0.00

Determining Potential for Direct Recharge in the Mississippi River Valley Alluvial Aquifer Using Soil Core Analyses, Washington County, Northwestern Mississippi

Rose

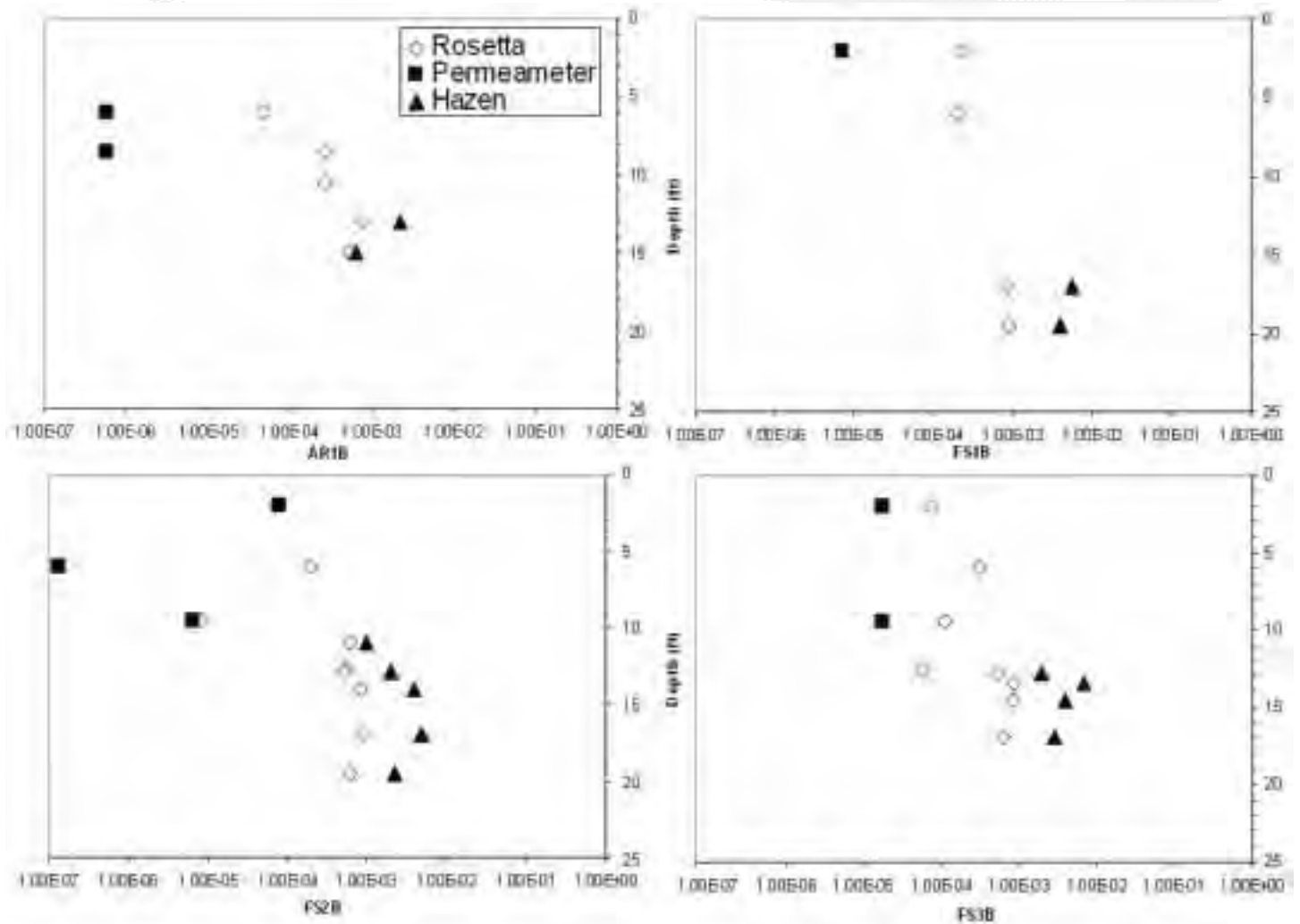

Figure 4. Relation of hydraulic conductivity values in centimeters per second, as estimated by three methods (falling head permeameter, Rosetta, Hazen) to depth in feet.

deeper sections of the wells to determine K values, these two methods could not be compared to each other. In the graph showing hydraulic conductivity values for the samples from AR1B, the FHP values do not match with the Rosetta values. The permeameter values are more than one order of magnitude lower from the Rosetta values. However, in this same graph, Rosetta and Hazen values are less than an order of magnitude different. In the graph of the hydraulic conductivity values for samples tested from FS1B, the FHP value is more than one order of magnitude less than the Rosetta value. For all other graphs, the FHP and the Rosetta values of K are not more than an order of magnitude different. Similarly, the Ro-

setta and the Hazen values of K are not more than one order of magnitude different in all graphs from each well.

Figure 5 shows a cross section through the study area that illustrates the placement of each well. The cross section of the study site, created from data gathered from analysis of soil cores, shows the layers of soil and the correlations of the layers between the wells. The cross section illustrates what all of the permeability, bulk density, and grain size data indicate, which is that there is a change in lithology below the 10-foot depth (fig. 5). Below the 10-foot depth, on the cross section, the lithology shifts from a silty clay loam and a silty loam to a fine, sandy loam (fig. 5).

DELTA GROUNDWATER

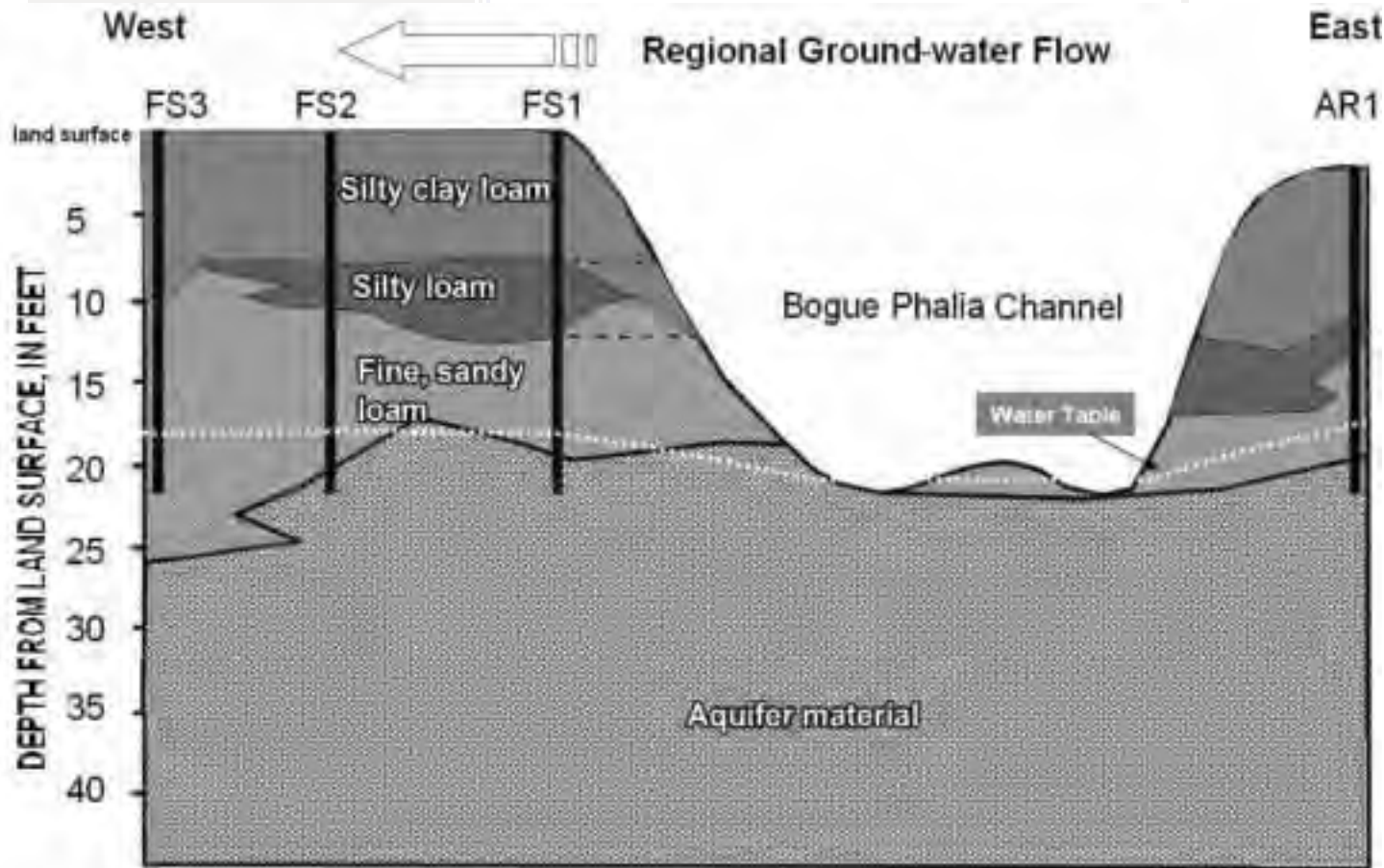

Figure 5. Generalized cross section of study site showing lithology.

Based on X-Ray diffraction (XRD), the mineralogy of the soil from 2 through 15 feet includes smectite clay, kaolinite, muscovite or illite, and quartz. In each sample, there were primarily four main d-spacing peaks. There was an ~ 14 Å (angstrom) peak, a 10.009 Å peak, a 7.180 Å peak, and a 3.342 Å peak. After glycolation, the 14 Å peak shifted magnitude to a $16-17$ Å peak. This indicated a swelling clay was present. There was no other change after glycolation. However, after the 400°C heating, the $16-17$ Å peak collapsed to 10 Å. This indicated that smectite was the swelling clay. Because the smectite peak collapsed to 10 Å, it was impossible to determine whether the original 10 Å Angstrom peak had collapsed or remained; therefore, it cannot be stated with certainty whether the 10 Å peak represents illite or muscovite. The 7 Å peak remained until 550°C heating, after which it collapsed; this represents kaolinite. However, for the sample AR1B 13.5 feet, the 7 Å peak remained even

after it was heated to 550°C . The 3.342 Å peak remained throughout all tests, and thus, it represents quartz.

Discussion and Conclusions

Previous models of the Mississippi River alluvial aquifer indicated that precipitation is the most important recharge component, as well as the greatest source of recharge in the alluvial aquifer flow system in the Delta. However, it is also the least studied component of the alluvial aquifer (Arthur, 2001).

The three methods used to determine K were the FHP, the Rosetta Model, and the Hazen method. These methods cannot all be compared directly, however, because the lack of cohesion of soil made it impossible to test the sandier sections in the permeameter, and the small grain sizes of the silty sections of soil made it impossible to test the sections using the Hazen method. It is good practice to obtain the hydraulic

Determining Potential for Direct Recharge in the Mississippi River Valley Alluvial Aquifer Using Soil Core Analyses, Washington County, Northwestern Mississippi

Rose

conductivity by several different methods. Generally, the data show that the FHP yielded lower hydraulic conductivity values, whereas the Hazen method yielded higher values than both the FHP and the Rosetta Model (table 1). However, the results from each method generally fell within the same order of magnitude (fig. 4).

Below the 10-foot depth, there is a change in material, validated by apparent changes in bulk density values, sand percentage, and permeability. The bulk density values above the 10-foot depth range from 1.78 to 2.20 grams per cubic centimeter, whereas below the 10-foot depth the bulk density values are lower, ranging from 1.21 to 1.78 grams per cubic centimeter (table 2). The sand percentage increases as depth increases. Above the 10-foot depth, the sand percentage ranges from 4.0 to 18.1 percent, whereas below the 10-foot depth, the sand percentage ranges from 20.7 to 99.6. The hydraulic conductivity data indicate that the upper 8 to 10 feet of soil consists of a silty clay loam with saturated vertical hydraulic conductivity values ranging from 10^{-5} to as low as 10^{-7} centimeters per second. The interval from 10 to about 16 feet was a sandy loam with hydraulic conductivity values ranging from 10^{-3} to 10^{-4} centimeters per second. The hydraulic conductivity values increase as the percentage of sand increases, and the K data from all four wells show that the hydraulic conductivity increases with depth.

K values obtained by the FHP test, for the upper 8 feet of soil, range from a magnitude of 10^{-6} to 10^{-5} centimeters per second. These values are typical for sandy silts and clayey

sands (table 3). At a depth of 6 feet, there was no flow through the soil cores after 24 hours from three of the four wells. This is due probably to the swelling smectite clay identified in the samples by X-Ray diffraction. The Rosetta Model predicted hydraulic conductivity values as high as 10^{-4} centimeters per second for the soil at a 2-foot depth. These values are also typical ranges of K values for sandy silts and clayey sands (table 3). The Hazen method predicted hydraulic conductivity values as high as 10^{-3} centimeters per second for the soils at a depth of 12-feet and more, which is in accord with the fine sands found at this depth, based on the values of intrinsic permeability (table 3). The FHP provided lower hydraulic conductivity values than the Rosetta Model or the Hazen method provided, because the permeameter gives saturated vertical hydraulic conductivity values whereas the Rosetta Model and the Hazen method both give saturated horizontal hydraulic conductivity values. Because of the stratified nature of the unconsolidated soils, the saturated vertical hydraulic conductivity (K_v) values will be lower (one or two orders of magnitude) than those of the horizontal hydraulic conductivity (K_h).

The results of this study indicate that it is unlikely that appreciable amounts of water penetrate vertically through the upper silty clay loam to the fine sandy unit that makes up the upper part of the alluvial aquifer at the study site, and at other similar locations in the Bogue Phalia Basin. This is not to say that other, non-vertical forms of recharge, such as horizontal recharge, do not occur. The Bogue Phalia incises

Table 2. Average bulk density value in grams per cubic centimeter per type of soil and the range of bulk density values per type of soil.

Soil Type	Average ρ_d value, in g/cm^3	Range of ρ_d value in g/cm^3
silty clay loam with organics to silty loam	2.03	1.78-2.20
fine, sandy loam	1.36	1.21-1.78
fine, sandy loam and medium sand	1.51	1.36-1.70

Table 3. Ranges of intrinsic hydraulic conductivities for unconsolidated sediments (from Fetter, 2001).

Material	Hydraulic Conductivity (centimeters per second)
Clay	10^{-9} - 10^{-6}
Silt, sandy silts, clayey sands, till	10^{-6} - 10^{-4}
Silty sands, fine sands	10^{-5} - 10^{-3}
Well-sorted sands, glacial outwash	10^{-3} - 1
Well-sorted gravel	10^{-2} - 1

DELTA GROUNDWATER

through the silty clay loam to the more permeable fine, sandy loam and, therefore, creates a potential pathway for lateral recharge to occur when the head in the river is greater than the head in the alluvial aquifer. In most cases, the Bogue Phalia is a gaining stream, meaning the head in the alluvial aquifer is usually higher than the head in the Bogue Phalia, causing the aquifer to recharge the river.

There are some discrepancies between the grain size analysis data and the field identification of the soil. The field identification matches the laboratory textural analysis of the soil type for the most part; whereas, both of these soil identification procedures yielded different results when compared to the grain size analysis data. The grain size data showed little or no clay was in the top 6 feet of soil. In the field identification, however, the top 6 feet are recorded as clay with silt and organics. The laboratory textural analysis classified the top 6 feet of soil as a silty clay loam. Natural Resources Conservation Service provides soil horizon data, and these data match closely with those gathered in the field. The upper 3 feet of soil in the study area was mapped as the Sharkey clay (Natural Resources Conservation Service, 2006). The Sharkey clay is listed as having 25-90 percent clay-sized particles. This discrepancy needs further review. In this study, all 26 samples indicated a small percentage of clay-sized particles.

This study did not address the possibility or probability of the occurrence of macroporosity. The possibility of root holes, worm holes, and mudcracks or soft sediment deformation in the soil can cause infiltration to occur if the cracks go deep enough to reach the sandier soil. Macroporosity can be common in low permeability soils, which can be due, in part, to the swelling nature of certain types of clays.

References

- Arthur, J.K. 2001. Hydrogeology, model description, and flow analysis of the Mississippi River alluvial aquifer in northwestern Mississippi. U.S. Geological Survey Water-Resources Investigations Report 01-4035, 40-45 p.
- ASTM Int'l, Standard D 2434-68, Reapproved 2000. Standard test method for permeability for granular soils (Constant Head).
- Blume, Theresa, and Weisbrod, Noam, and Selker, J.S. 2002, Permeability changes in layered sediments: Impact of particle release. *Ground Water*. Vol. 40. No. 5 September-October 2002. Pages 466-474.
- Boswell, E.H., Cushing, E.M., and Hosman, R.L., 1968, Quaternary aquifer in the Mississippi Embayment With a discussion of Quality of water by Jeffery, H.G.: U.S. Geological Survey Professional Paper 448-E, 15 p.
- Capel, P.D., Hamilton, P.A., and Erwi, M.L., 2004, Studies by the U.S. Geological Survey on sources, transport, and fate of agricultural chemicals: U.S. Geological Survey Fact Sheet 2004-3098, 4 p.
- Coupe, R.H. 2000. Occurrence of pesticides in five rivers of the Mississippi Embayment Study Unit, 1996-98: U. S. Geological Survey Water-Resources Investigations Report 99-4159, 30 p.
- Coupe, Richard and Capel, Paul, 2005, Bogue Phalia Watershed in Mississippi selected for a national water-quality study: U.S. Geological Survey Fact Sheet 2005-3050, 2 p.
- Dane, J.H., and Topp, G.C., eds., 2002, *Methods of Soil Analysis, Part 4 Physical Methods* Published by the Soil Science Society of America Madison, Wis.
- Fetter, C.W., 2001, *Applied hydrogeology*, 4th ed. Prentice Hall Inc. Upper Saddle River
- Hall, Robert, undated, Soil Geomorphology Laboratory. Particle Size Determination (Pipette Method). Accessed July 2006. <<http://www.geology.iupui.edu/research/SoilsLab/procedures/psd/>>
- Hall, Robert, undated, Soil Geomorphology Laboratory. Bulk Density Determination. Accessed July 2006. <http://www.geology.iupui.edu/research/SoilsLab/procedures/bulk/index.htm>

DELTA GROUNDWATER

Determining Potential for Direct Recharge in the Mississippi River Valley Alluvial Aquifer Using Soil Core Analyses, Washington County, Northwestern Mississippi

Rose

Midwest Geosciences Group, 2001, USDA soil texturing field flow chart. Midwest Geosciences Group Press, data available on the Web, accessed July 2006 at <<http://www.midwestgeo.com>>

Natural Resources Conservation Service, Web Soil Survey, 2006: NRCS data available on the Web, accessed July 2006 at <http://websoilsurvey.nrcs.usda.gov/app/WebSoilSurvey.aspx>

Noll, M. R., Building bridges between field and laboratory studies in an undergraduate groundwater course, <http://www.nagt.org/files/nagt/jge/abstracts/Noll_v51n2.pdf>

Raynolds, R.G.H., Johnson, K.R., Arnold, L.R., Farnham, T.M., Fleming, R.F., Hicks, J.F., Kelley, S.A., Lapey, L.A., Nichols, D.J., Obradovich, J.D., Wilson, M.D., 2001, The Kiowa core, a continuous drill core through the Denver Basin bedrock aquifers at Kiowa, Elbert County, Colorado: U.S. Geological Survey Open-File Report 2001-185, 127 p.

Rosetta Model. 1999. USDA Website. Edition 1.0 www.usda.gov/pls/caliche/ftpinfo?model_in=rosetta, www.usda.gov/Services/docs.htm?docid=8953.

Shepherd, R.G. Correlations of permeability and grain size: *Ground Water*, Vol. 27, No.5. September-October 1989, 633-638 p.

Snider, J.L., and Sanford, T.H., Jr., 1981, Water resources of the Terrace aquifers, central Louisiana: Louisiana Department of Transportation and Development, Water Resources Technical Report No. 25, 48 p.

Starkey, H.C., Blackmon, P.D., and Hauff, P.L., 1984. The systematics of clay mineral identification. U. S. Geological Survey Bulletin 1563.

Taylor, R.E., and Thomson, F.H., 1971, Water for industry and agriculture in Washington County, Mississippi: Delta Council Bulletin, 64 p.

TerraServer USA. 2005. <<http://terraserver.microsoft.com/image.aspx?T=1&S=10&Z=15&X=3504&Y=18494&W=1&qz=%7cleland%7cms%7c>> Accessed last on January 1, 2007.

DELTA GROUNDWATER

Changes in Water Volume in the Mississippi River Valley Alluvial Aquifer in Northwest Mississippi

Mark Stiles and Dean Pennington
YMD Joint Water Management District
PO Box 129
Stoneville MS 38776
662-686-7712
Email: mark@ymd.org

ABSTRACT

The Mississippi River Valley Alluvial (MRVA) aquifer in Northwest Mississippi is the primary source for agricultural crop irrigation in the Mississippi Delta. The water levels in the aquifer have generally declined in the past twenty years. Typically, the area in the center of the Delta experiences annual water level declines of approximately one foot. Several methods of analysis and display have been used to characterize these changes. These methods generally include the creation of hydrographs, contour maps, and two dimensional color grid maps of water level changes over a specified time interval. While these methods are useful for showing the areas of decline, the actual net gain or loss of water stored in the aquifer wasn't able to be accurately calculated. Due to recent enhancements in water level surface determinations and updated historical water level measurements we can now calculate the approximate annual change in the volume of water in the MRVA aquifer. A water level surface grid is interpolated using the measurements taken for a given year then subtracted from the previous year's surface. By using a one acre grid cell for both surfaces, the calculated difference value reflects the acre-feet of aquifer volume change for each grid cell. Then by adding all the change values for the entire one-year difference grid and applying a specific yield coefficient the change in water volume from one year to the next can be calculated. This annual change in water volume is very useful in understanding and protecting the Delta's abundant supply of water.

Keywords: Ground Water, Water Quantity, Agriculture, Irrigation, Water Use

Potential for infiltration through the fine-grained surficial deposits of the Bogue Phalia Watershed, Mississippi

Patrick C. Mills, Jeannie R. Bryson, Claire E. Rose, and Richard H. Coupe
U.S. Geological Survey, Water Resources Discipline
Illinois Water Science Center
1201 W. University Ave.
Urbana, IL 61801
217-344-0037 x3027
Email: pcmills@usgs.gov

ABSTRACT

The U.S. Geological Survey is conducting a preliminary assessment of the potential for deep infiltration of water and ground-water recharge through fine-grained Mississippi embayment deposits. Findings of this study will provide insight into the potential for transport of agricultural chemicals to ground water in this and similar humid regions of the United States. During an annular period that began in March 2006, various sediment-physical-property, sediment-hydraulic, ground-water, stream-flow, and meteorologic data will be collected at two sites in the Bogue Phalia River watershed. The paired sites allow study of the somewhat varying sediment compositions distributed across the watershed. Relatively sandy soils planted with cotton compose the northern site near Gunnison; relatively sand-free soils planted with soybeans compose the southern site near Leland. Both sites are within 0.1 mile of the Bogue Phalia River. Within the study area, about 13 feet of predominantly silt sediments overlie at least 100 feet of sand deposits. The coarse sediments compose the Mississippi embayment alluvial aquifer, with ground-water levels generally about 15-30 feet below land surface. Instrumentation includes vertically nested piezometers and soil-moisture sensors, as well as a meteorologic station, deep ground-water well, and streamgage. Much of the instrumentation is monitored continuously with data-logging devices and the data served to the World Wide Web.

Preliminary data from the growing season of March-September 2006 indicate infiltration generally is limited to the uppermost 3-4 feet of the soil horizon, or just below the primary root zone of the planted crops. Following rainfall events, no appreciable increase in soil-moisture content was detected at monitored depths approaching 9 feet. Underlying ground-water levels and stream stage responded almost instantaneously to these events, indicating that the aquifer and nearby river are in direct hydraulic connection with ground-water levels affected by stream stage. The fine composition of the surficial sediments (generally containing less than 25 percent fine sand) and their presumably low vertical hydraulic conductivity appear to inhibit the deep infiltration of water. Presently, available data are not adequate to differentiate between the deep-infiltration characteristics of the varying sediment compositions that distinguish the two study sites. Additionally, the reported growing season was unusually dry, with 25 to 50 percent of normal seasonal rainfall (about 18 inches recorded). Infiltration response during a seasonally wet period, when evapotranspiration rates are correspondingly low, will need to be monitored to more fully assess the potential for deep infiltration through these fine-grained sediments.

Keywords: Ground Water, Hydrology, Sediments, Methods

DELTA GROUNDWATER

Introduction

The Mississippi Delta region (fig. 1) is a rich agricultural area that is a substantial source of cotton, soybeans, rice, and corn. To help maintain this level of production, approximately 9 million pounds of pesticides are applied annually in Mississippi for control of grasses, weeds, insects, and fungi (U.S. Department of Agriculture, 2006a). With this substantial usage of pesticides, there is a potential risk to the quality of the region's surface and ground waters. To address such questions concerning the sources, transport, and fate of agricultural chemicals, the U.S. Geological Survey (USGS) is undertaking hydrologic-based studies in various agricultural and natural settings across the Nation, including the Bogue Phalia River Basin, Miss. (Erwin and others, 2005). The climate, geology, and hydrology of this basin are considered

characteristic of the Mississippi Delta region, as well as other humid, subtropical settings in the southeastern United States. The studies in the various areas will examine how natural factors (including climate, geology, topography, and soils) and management practices (including crop type, chemical use, tillage, vegetated buffering) may affect the fate and transport of agricultural chemicals.

Past studies of agricultural-related ground-water quality in the Mississippi Delta region indicate detections of one or more pesticides in about 13 to 36% of the wells that were sampled (Gonthier, G.J., 2003; Office of Pollution Control, 2004). These wells typically were supply wells that penetrate most of the approximately 135 ft thickness of the uppermost Mississippi River Valley alluvial aquifer. There is limited understanding of how these agricultural chemicals are

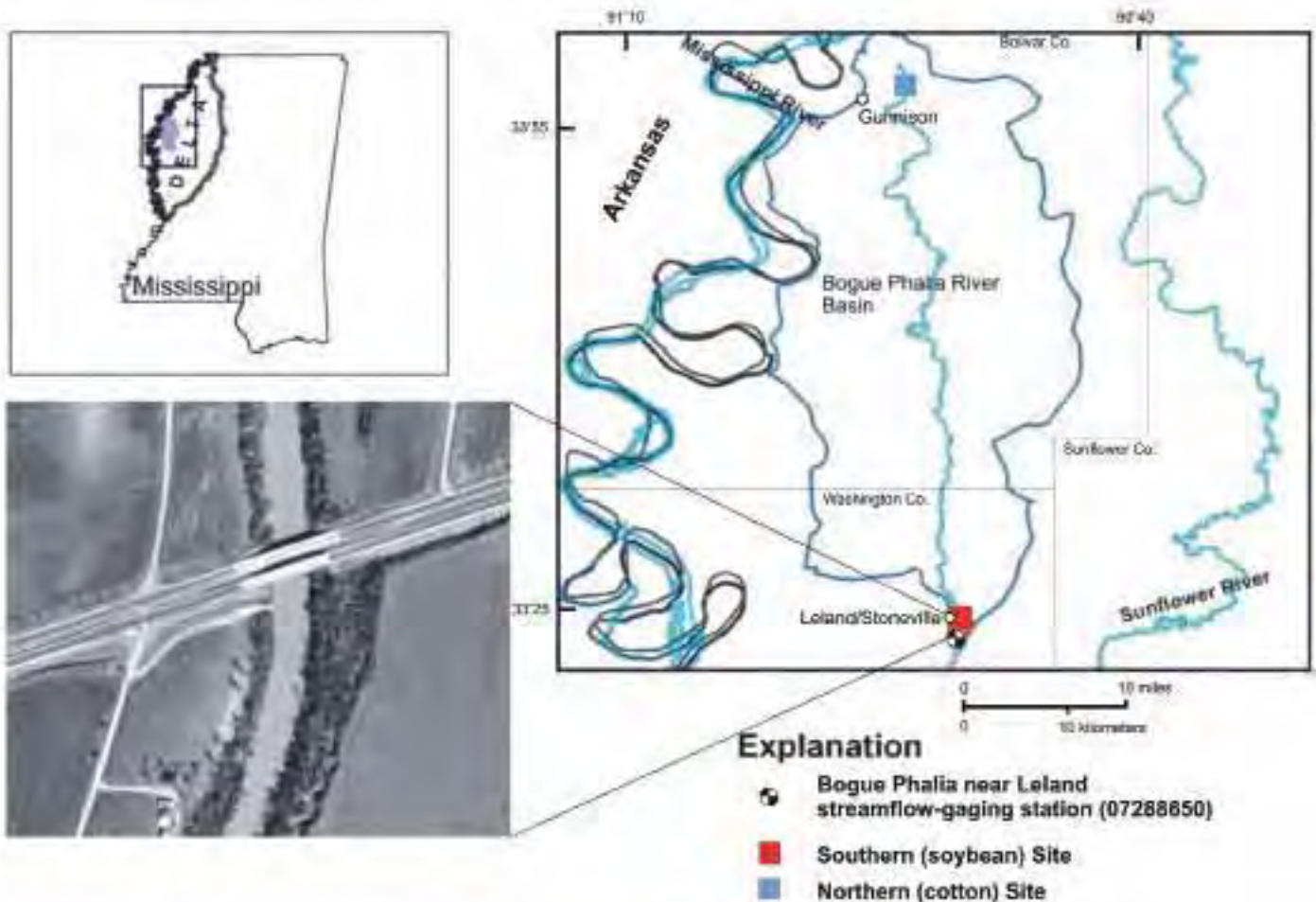

Figure 1. Location of study sites in the Bogue Phalia River Basin, Mississippi.

Potential for infiltration through the fine-grained surficial deposits of the Bogue Phalia Watershed, Mississippi Mills, et al

transported to ground water, particularly because there are few, if any, studies of deep infiltration through the approximately 25 ft thick unsaturated soils that almost fully overlie the aquifer. In addition, there are few, if any, studies of water quality at and near the water table. Water movement below the root zone that is unaffected by near-surface evapotranspiration is a potentially important mechanism for transport of agricultural chemicals to the underlying aquifer. Various estimates of average annual recharge to the aquifer by direct infiltration of precipitation through the overlying soils range from 0.5 (Sumner and Wasson, 1990) to 2.6 in/yr (Author, 2001; Krinitzky and Wire, 1964). Flow simulation by Author (2006) indicates that direct infiltration represents 86% of total recharge to the aquifer and 5% of annual precipitation. To a lesser extent, vertical leakage from surface-water bodies contributes recharge to the aquifer. The magnitude of this local contribution generally is greatest during wet spring and summer months and where these water bodies deeply incise the fine-grained soils that overlie the aquifer. The present USGS field study in the Bogue Phalia River Basin intends, in part, to assess the relative contribution of various sources of recharge to the Mississippi River Valley alluvial aquifer, and to determine the flux of water and agricultural chemicals through the fine-grained soils that overlie the aquifer.

This paper presents results of a preliminary assessment of the performance and utility for this study of a selected type of dielectric sensor in measuring volumetric soil-moisture content (VMC) and changes in VMC associated with infiltration or evapotranspiration. A brief preliminary conceptualization of the potential for deep infiltration of water through the surficial fine-grained soils of the Bogue Phalia River Basin also is presented and is based on available VMC's and associated data.

Methodology

Two study sites were established in the 484 mi² Bogue Phalia River Basin (fig. 1). A southern site was instrumented in the lower part of the basin near Leland (Washington Co.) and a northern site was instrumented in the upper part near Gunnison (Bolivar Co.). The separate sites allowed study of infiltration through different soil-textural compositions and

crop types. Predominantly silty clay to clayey silt soils planted with soybeans are present at the southern site; comparatively sandier clayey silt soils planted with cotton are present at the northern site. The fine-grained soils are about 13 ft thick at the southern site and range from about 7.5 ft to greater than 16 ft thick at the northern site (figs. 2, 3). These fine-grained soils overlie fine sands that compose the lower part of the unsaturated zone and upper part of the aquifer. Depth to the water table is about 17 ft at the southern site and 25 ft at the northern site.

Each study site is instrumented to allow monitoring of water movement through the unsaturated zone to the water table. Additionally, precipitation is monitored at or near each site and streamflow is monitored near the southern site. Instruments at the southern site are installed along an 800-ft transect approximately normal to the river channel. Instruments at the northern site are installed in two clusters: in comparatively siltier soils about 200 ft from the river (referred to as the "near-river" site) and comparatively sandier soils about 1,300 ft from the river (referred to as the "west" site) (fig. 3).

To monitor VMC, electronic sensors (Decagon Devices, Inc., 2006) (fig. 4) were installed in vertically nested pairs (fig. 3). A shallow sensor typically was positioned just below the anticipated crop root zone (about 3-4 ft below land surface) and a deep sensor about mid-depth between the

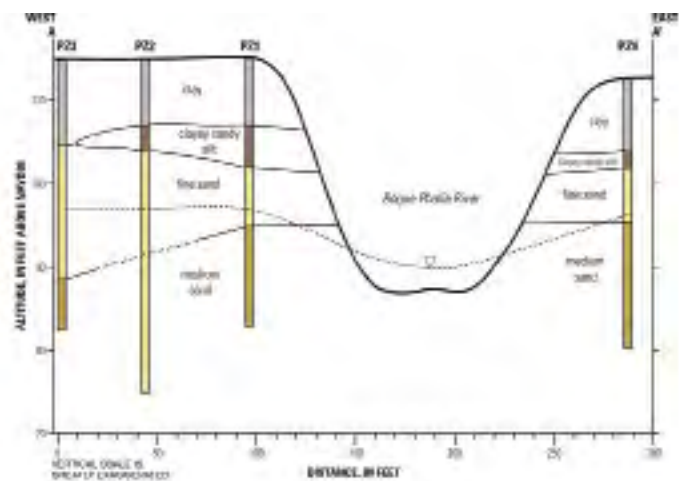

Figure 2. Hydrogeologic cross section of the southern study site in the Bogue Phalia River Basin, Mississippi.

DELTA GROUNDWATER

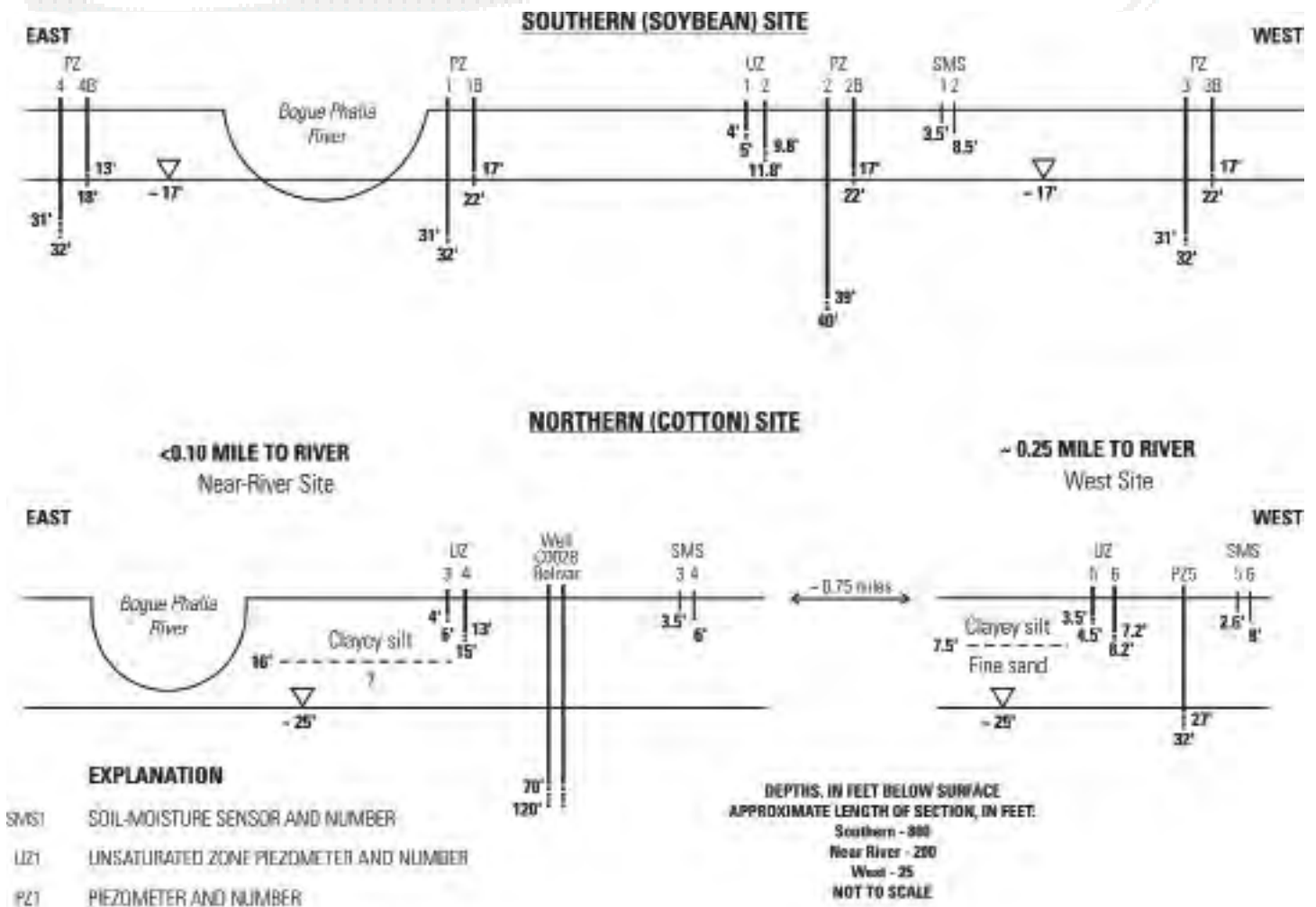

Figure 3. Cross sections showing instrument locations, depth to the water table, and selected stratigraphy at the southern and northern study sites in the Bogue Phalia River Basin, Mississippi.

soil surface and the water table (about 6-10 ft below land surface). The sensors were installed through the base of a 2- or 5-in.-diameter vertical core hole (fig. 5c) and the core hole backfilled with native soils in a manner intended to replicate the stratigraphy and bulk density of the native soils. Additionally, about 1 ft of bentonite was placed as backfill near the top of most core holes to further ensure they do not act as preferential conduits for deep infiltration. The sensors at each study site were connected to a digital data logger, with measurements recorded every 15 minutes.

The VMC sensors are a capacitance device that measures the dielectric constant (permittivity) of the medium

(soil, water) in which they are installed. This measurement is made by determining the rate of change of voltage applied to the embedded sensor. The high value of permittivity of water (about 80) relative to that of most soils (about 4) and air (about 1) allows ready detection and measurement of deviations from ambient permittivity (which approximates soil permittivity) (Decagon Devices, Inc., 2007). On this basis, changes in VMC can be readily detected and measured as wetting and drying occurs in association with infiltration or evapotranspiration cycles. From this capacitance measurement, a mathematical model of the linear relation between the output voltage of the sensors, in millivolts (mv), and VMC

Potential for infiltration through the fine-grained surficial deposits of the Bogue Phalia Watershed, Mississippi Mills, et al

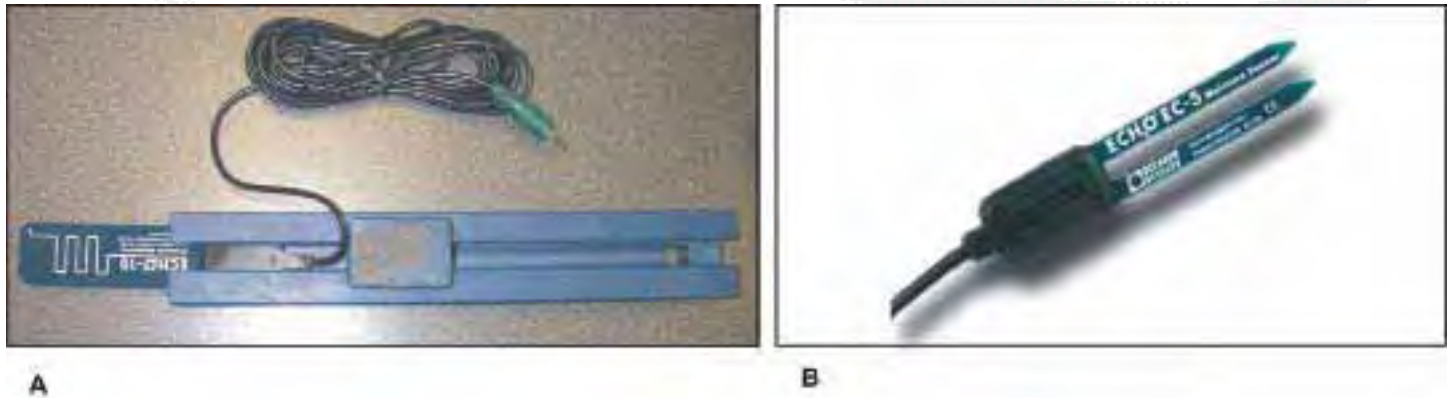

Figure 4. Soil-moisture sensors installed in the fine-grained soils of the Bogue Phalia River Basin, Mississippi study sites: (A) model installed in first phase, April 2006, (B) model installed in second phase, January 2007.

can be resolved (Cobos, 2007). For the sensors used in the study with a 2,500 mv excitation current, the model determined from generic (manufacturer) calibration is:

$$VMC = 0.00093 * mv - 0.376.$$

Capacitance sensors generally are considered to be readily affected by salinity and temperature conditions because of the low frequency (<10MHz) of the applied oscillating voltage. Additionally, electrical properties of soils can vary with soil texture, resulting in comparatively less accurate measurement of the permittivity of coarse-textured soils by the sensors. However, the circuitry design of the sensors used in this study and the soil conditions of the study sites (temperatures between -20 to 50° C, salinity less than 500 μS/cm, and predominantly fine-grained soils) are such that these factors are not expected to appreciably affect the measurement accuracy of the sensors. In fact, the site soil conditions are considered similar enough to the soil conditions used in the generic (manufacturer) calibration of the sensors (table 1) that site-soil-specific calibration was concluded to be unnecessary. Measurement accuracies of about +/- 4% VMC are expected (Decagon Devices, Inc., 2006).

In an attempt to directly capture infiltrating water, unsaturated-zone (UZ) piezometers were installed adjacent to each cluster of soil-moisture sensors. Similar to a gravity lysimeter, the 1-in.-diameter UZ piezometers consisted of a 1- to 2-ft long slotted screen with 1 ft of bottom-sealed cas-

ing attached to the base of the screen. Mid-points of the UZ piezometer screens were set at the approximate depths of the sensors (fig. 3). Beginning in June 2006, water levels in the piezometers have been monitored during most site visits. The visits generally have been made weekly to monthly. When standing water has been detected, the height of the

Soil type - source	Sand, in %	Silt, in %	Clay, in %	Electrical conductivity in μS/cm
Sandy silt loam - BF ¹	12-25	68-83	5-90 ²	<500 ³
Loam - G ⁴	47	29	24	90
Silt loam - G	3	71	26	120
Silty clay loam - G	3	68	29	90
Silty clay - G	17	41	42	1,480

¹Bogue Phalia River Basin study sites
²Upper value from U.S. Department of Agriculture (2006b)
³Estimated
⁴Generic (manufacturer) calibration

DELTA GROUNDWATER



Figure 5. Installation of unsaturated-zone monitoring instruments at the Bogue Phalia River Basin, Mississippi study sites: (A) direct-push rig used to collect cores for installation of piezometers and soil-moisture sensors (looking west along piezometer transect at the southern study site); (B) sensor and insertion tool; (C) insertion of sensor; and (D) data-logging station for recording sensor data, and flush-mounted unsaturated-zone and water-table piezometers.

water column has been measured. As planned, the standing water was to be evacuated after each measurement, but to date this has not been done regularly. It is assumed that any flow into the piezometers results from soil moistures at or near saturation levels and not from preferential drainage down the annulus adjacent to the piezometer casing. This assumption is considered valid because the annulus of each piezometer was backfilled with bentonitic clay.

At the southern site, conventional 1-in.-diameter piezometers were installed in the saturated zone in four vertically nested pairs along the instrument transect (figs. 4, 5). Each pair consists of one piezometer with a 5-ft screen positioned

near the water table (about 17 ft below land surface) and another with a 1-ft screen about 10 to 20 ft below the water table. During the initial spring-fall 2006 study period, measurement of water levels in all piezometers were made only during site visits; future data-collection plans include installation of pressure transducers for continuous monitoring of levels in some piezometers. Precipitation at this site is measured by a tipping-bucket gage co-located with a USGS streamflow-gaging station (07288650) about 1 mi south of the site (fig. 1). Site precipitation data are supplemented by measurements at the Mississippi Agricultural Experimental Station at Stoneville, Miss., about 4 mi northwest of the study

DELTA GROUNDWATER

Potential for infiltration through the fine-grained surficial deposits of the Bogue Phalia Watershed, Mississippi

Mills, et al

site (National Weather Service, 2007a).

The instrument cluster at the northern near-river site is co-located with an unused irrigation well and a tipping-bucket rain gage (fig. 3). The well is screened from 70 to 120 ft below land surface. Ground-water levels and rainfall are recorded automatically at 15-minute intervals by a digital data logger. The instrument cluster at the northern west site, located about 0.75 mi west of the near-river site, includes vertically nested soil-moisture sensors, UZ piezometers, and a conventional piezometer positioned near the water table (fig. 3).

Automatically logged data from the northern near-river site and the USGS streamflow-gaging station are transferred by satellite telemetry to the USGS Mississippi Water Science Center Web site (<http://ms.water.usgs.gov/>). Additionally, soil cores were collected during installation of the monitoring instruments and analyzed for various physical properties including particle-size distribution (soil texture), bulk density, soil-moisture content, and hydraulic conductivity.

Results

Following are the initial assessments of the performance of the soil-moisture sensors and the potential for deep infiltration through the fine-grained soils at the two Bogue Phalia River Basin study sites. These assessments are considered preliminary, pending possible additions to instrumentation along with full data collection and analysis.

Performance of Soil-Moisture Sensors

Soil cores collected near and at the installation depths of the sensors were used for verification of sensor-determined VMC's. Analysis of the VMC of southern study site cores collected about one month before the sensors were installed indicates that initially, most sensor values were acceptably close to existing field values (table 2). Differences between the core and sensor-determined VMC's are attributed primarily to (1) disturbance of ambient soil-moisture conditions during sensor installations, resulting in drier soils as measured by the sensors; and (2) differences in ambient soil-moisture between the March and April collection and measurement dates. In January 2007, additional sensors were installed at

Table 2. Comparison of initial values of volumetric moisture content, as measured by soil-moisture sensors installed at the southern study site in the Bogue Phalia River Basin, Mississippi, and moisture contents of cores collected near or at the depths of the sensors.

Soil-moisture sensor or core	Sensor or core depth, in ft ¹	Representative date of moisture value	VMC ² in m ³ /m ³
SMS1	3.5	04-27-06	0.34
Core1	4.0	03-28-06	.46
SMS2	8.5	04-27-06	.31
Core2	8.0	03-28-06	.37

¹below land surface
²volumetric moisture content

both study sites. Cores also were collected at the depths of the sensors to better assess the reliability of the sensor measurements. Results are pending for the VMC analysis of these sensors and cores.

Following the disturbance of sensor installation, several weeks seemed to be required to reestablish near-in situ conditions of soil moisture and compaction (figs. 6, 7, 8). Post-equilibration measurements of VMC by most of the sensors seem reasonable, particularly in late spring through early July. During that period, VMC's ranged from about 0.3 to 0.4 m³/m³, which generally is consistent with the measured values in nearby soil cores (table 2; figs. 6, 7, 8). The shallow sensor installed at the northern west site (fig. 3) did not seem to perform acceptably, as its measured VMC's were consistently about 0.06 m³/m³. During mid-summer, performance problems developed with many of the sensors. To a varying extent, these problems have limited their usefulness in measuring VMC and monitoring infiltration through the fine-grained soils of the sites.

The expected level of performance of the sensors can be seen best in the record of VMC's from the northern near-river site (fig. 7). These sensors have provided seemingly reliable measurements throughout the study period. Following the early equilibration period, cycles of wetting and drying soils

DELTA GROUNDWATER

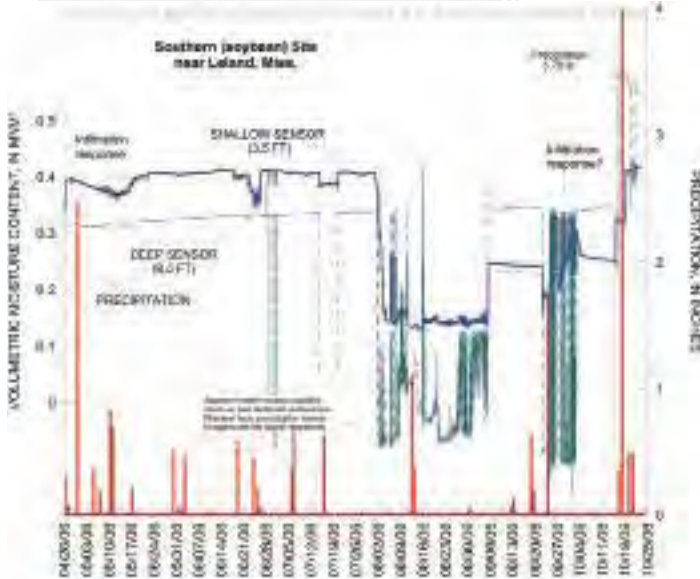

Figure 6. Soil moisture and precipitation at the southern study site in the Bogue Phalia River Basin, Mississippi, April-October, 2006.

have been recorded by the shallow sensor in response to precipitation events. VMC's at this site approach a maximum of about $0.35 \text{ m}^3/\text{m}^3$. The ambient VMC's measured during periods of limited precipitation seem unexpectedly low for depths below the root zone (about 3 ft below land surface) in fine-grained soils. Measured VMC's were about $0.15 \text{ m}^3/\text{m}^3$ for the deep sensor and $0.2 \text{ m}^3/\text{m}^3$ for the shallow sensor. However, VMC's determined from cores collected near the respective depths of the sensors (but at different times) were $0.27 \text{ m}^3/\text{m}^3$ and $0.08 \text{ m}^3/\text{m}^3$. Increasing evapotranspiration related to seasonal warming and crop emergence through the summer months is expected to have limited infiltration to soil depths below the root zone. Additionally, this was the beginning of a period of limited precipitation, with only about 14 in. during May through September (about 11 in. at the southern site). The long-term average for this location is about 18 in. (National Weather Service, 2007a, b). Soils in the vicinity of the deeper sensor also may be sandier than the soils distributed elsewhere at this site, thus accounting for the lower than expected VMC. To assess the accuracy of the deep sensor, additional cores were collected near the sensor in January 2007 for analysis of VMC

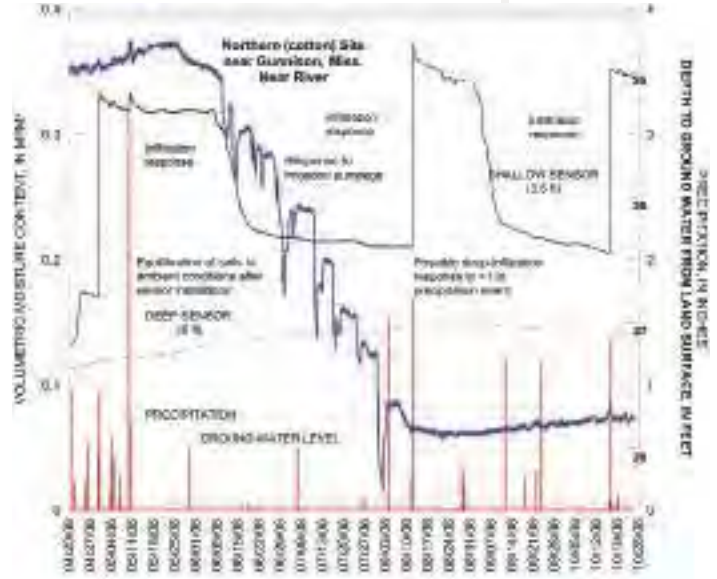

Figure 7. Soil moisture, precipitation, and ground-water levels at the northern near-river study site in the Bogue Phalia River Basin, Mississippi, April-October, 2006.

and particle-size distribution.

In mid-July, near-simultaneous fluctuations and unrealistic decreases in the output signals of both soil-moisture sensors at the southern site began to occur (fig. 6). These fluctuations increased in the following weeks, rendering the measurements unusable. With visual filtering, early portions of the output data signal are extractable for measurement of VMC's. Around the first of July, the shallow sensor at the northern west site rapidly failed, with output values thereafter indicating unrealistic moisture contents (greater than $1.0 \text{ m}^3/\text{m}^3$); a similar failure of the deep sensor occurred several weeks later (fig. 8). Both failures occurred during hot, dry periods, with little precipitation during the preceding weeks. Prior to that time, neither sensor responded to the few precipitation events that occurred earlier in the summer; however, most of these events totaled less than 1 in.

It is difficult to specifically determine the cause of the performance problems associated with various soil-moisture sensors. Although not individually tested or calibrated prior to installation to assure against manufacturing problems, their history of effective use in other settings (E.A. Smith, U.S. Geological Survey, oral commun., 2006) and their seem-

Potential for infiltration through the fine-grained surficial deposits of the Bogue Phalia Watershed, Mississippi Mills, et al

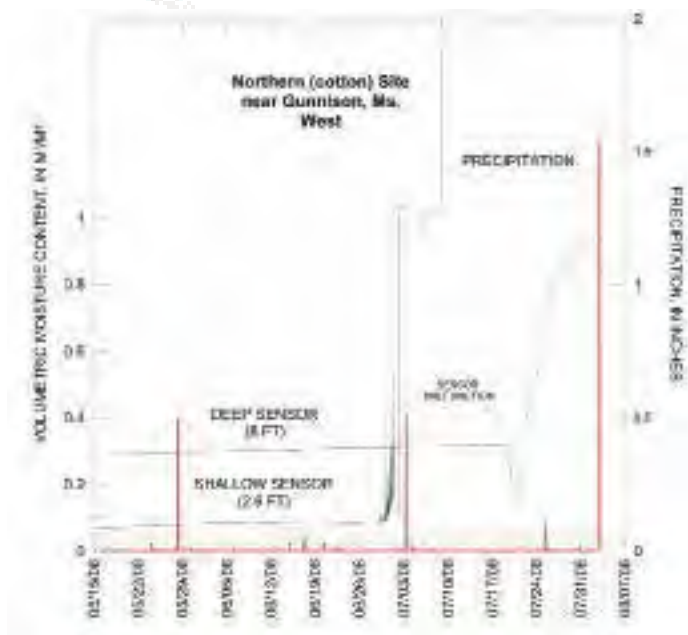

Figure 8. Soil moisture and precipitation at the northern west study site in the Bogue Phalia River Basin, Mississippi, May-August, 2006.

ingly reliable early time performance in this study suggest the problems may be related to one of the following issues.

- The epoxy-impregnated circuit boards that encase the electronic circuitry of the sensors may have been damaged during insertion of the sensors into the dense, clay-rich soils at the study sites. The likelihood of this damage is greatest at the southern site where the Sharkey clay soils are present. Difficulty in aligning the sensors with the insertion slots made at the base of the deep, small-diameter core holes using the bladed sensor-insertion tool further compounded installation problems. Through time, moisture may have come into direct contact with the circuitry of the damaged sensors. However, the near-simultaneous signal surges that occurred in the vertically nested sensors at the southern site are not readily accounted for by this explanation.
- The buried cabling that connects the deeper-buried sensors to the data loggers may have been damaged following sensor installation. Such damage could explain the near-simultaneous surges of the sensor signals at the southern site as well as the apparent sensor

failures at northern west site. However, all cables were buried in plastic pipe at a depth of about 2 ft; thus, it seems unlikely that the sensors or cabling were damaged by subsequent plowing or by shrinkage cracks that developed in the near-surface soils during the dry summer months.

- The near-simultaneous signal surges in both shallow- and deep-buried sensors at the southern site suggest a near-surface cause, possibly associated with problems with the power-supply system. Electrical connections may have been loose and(or) moisture may have been present where the sensors and the solar cell/battery assemblies connect with the data loggers. However, no apparent problems have been identified upon inspection of these systems.

One additional limitation of the sensors is that the maximum VMC that can be recorded is $0.40 \text{ m}^3/\text{m}^3$. As noted in the VMC measurements by the shallow sensor at the southern site during May through July (fig. 6), the maximum output signal may have been exceeded several times. This limitation can be avoided in future applications by employing an alternative model of capacitance sensor available from the manufacturer. That model can measure moisture VMC's up to $1.0 \text{ m}^3/\text{m}^3$. Despite the noted problems, the overall performance of the sensors was considered positive enough to warrant their continued use at the study sites. Their performance will continue to be monitored to ensure the sensors satisfy the data-quality objectives of the study. It is anticipated that installation of the alternative sensor model will be necessary to fully describe and quantify water movement through the unsaturated soils at the sites.

Potential for Deep Infiltration

Soil texture, permeability, moisture-content, and groundwater-level data available from spring through fall 2006 allow preliminary assessment and conceptualization of the potential for deep infiltration of precipitation through the fine-grained soils at the Bogue Phalia River Basin study sites. Soil-texture data collected at various depths indicate an upper soil horizon composed predominately of silts and clays; the horizon ranges from about 7.5 ft to greater than

DELTA GROUNDWATER

16 ft thick. Soil data collected at the sites (Rose, 2007) and available from nearby U.S. Department of Agriculture (2006b) surveys indicate clay contents in this horizon range from 5 to 90%. The highest clay content was in the Sharkey Clay soils at the southern site. Silt content typically is greater than 68%. Underlying these fine-grained soils, generally present at least to the depth of the water table, is a horizon consisting of fine to very fine sand. Bulk densities of these soils generally range from about 1.3-1.7 g/cm³ (R.W. Healy, U.S. Geological Survey, written commun., 2006) (fig. 9) and are greatest, exceeding 1.6 g/cm³, near mid-depth of the fine-grained horizon (about 8 ft) and in the upper part of the fine-sand horizon (below about 13 ft). Vertical hydraulic conductivities of the fine-grained soils at the southern study site, as determined from laboratory permeameter measurements, range from about 1×10^{-2} to less than 10^{-3} ft/d, with a geometric mean of about 9×10^{-3} ft/d (Rose, 2007). The fine texture, high density, and low vertical hydraulic conductivity of the uppermost fine-grained soil horizon suggest limited potential for infiltration of precipitation to the underlying Mississippi River Valley alluvial aquifer. Evidence of expandable smectitic clays within the fine-grained soils at the southern site (Rose, 2007) further suggests a limited potential for deep

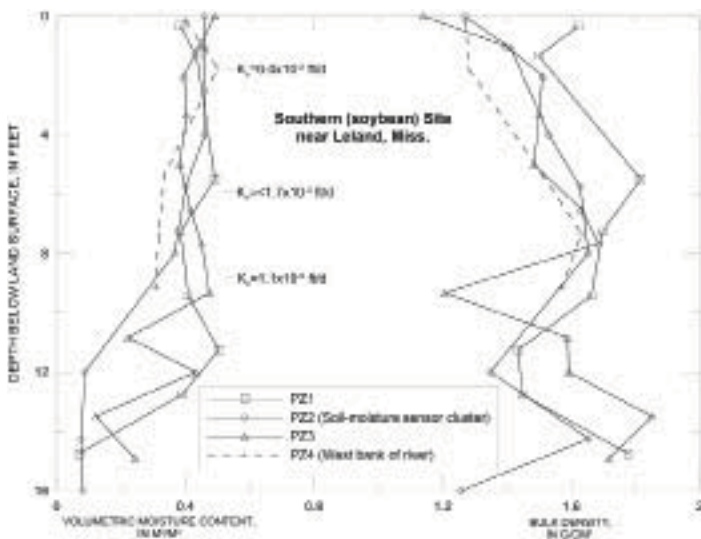

Figure 9. Volumetric moisture content, bulk density, and vertical hydraulic conductivity of soils at the southern study site in the Bogue Phalia River Basin, Mississippi (moisture content and density data from R.W. Healy [U.S. Geological Survey, written commun., 2006]; conductivity data from Rose [2007]).

infiltration through these soils.

The available soil-moisture data from the study sites also suggest limited potential for deep infiltration. At both the southern and northern near-river sites, shallow infiltration to a depth of about 3.5 ft is indicated in response to selected precipitation events that individually or collectively exceed about 1 in.

At the southern site, infiltration responses seem to have occurred following storms in mid-May, late September, and mid-October that produced about 1.5 in., 1.75 in., and 5.7 in. of precipitation, respectively. The responses in the fall months are not certain because of the erratic sensor output (fig. 6). Although the soil-moisture increase associated with the first event appears to be only about 0.05 m³/m³, it is likely greater. As previously discussed, the maximum VMC measured by the sensors is 0.40 m³/m³. There appears to be an increase in VMC of about 0.1 m³/m³ associated with the September event and possibly about 0.1 m³/m³ or more with the October event. In both these cases, the actual VMC may be higher than the recorded value of about 0.40 m³/m³. It is uncertain why there was no apparent response to the approximately 2.5-in. event in late April. Possibly the precipitation total applied here from the Stoneville, Miss., precipitation gage exceeded the actual total at the study site. The recorded total from the site (0.86 in.) was presumed to be underestimated and thus was not used in this evaluation. It also is possible that the apparent infiltration response in mid-May is a delayed response to the two large storms during the previous two weeks.

At the northern site, infiltration responses are observed in late April, mid-May, early August, and mid-September (fig. 7). The response in April followed multiple precipitation events distributed over about one week, each of which produced about 0.5 in. of precipitation. The increase in VMC associated with these events was about 0.18 m³/m³. This infiltration primarily contributed to the equilibration of soils to ambient conditions following sensor installation. About two weeks later, following about 3.25 in. of precipitation, there was an additional increase in soil moisture at the 3.5-ft depth. However, the comparatively small increase in VMC of only 0.01 m³/m³ suggests the soils were already near

Potential for infiltration through the fine-grained surficial deposits of the Bogue Phalia Watershed, Mississippi

Mills, et al

saturation, thus allowing minimal infiltration. Most of the water from that large storm presumably drained from the field as runoff to the nearby river. This assumption is supported by the accompanying rapid and near-simultaneous rise in ground-water levels (fig. 7), which has been attributed to a response to rising river stages (Ackerman, 1989; Sumner and Wasson, 1990). The infiltration response in August followed two storms producing about 1.5 in. of precipitation each, spaced about one week apart. The associated increase in VMC's was about $0.15 \text{ m}^3/\text{m}^3$. In September, moisture contents at the depth of the shallow sensor increased by about $0.15 \text{ m}^3/\text{m}^3$ following a storm producing about 1.5 in. of precipitation. The varying responses to the storms in August and September, along with the seemingly low ambient soil-moisture content (about $0.22 \text{ m}^3/\text{m}^3$) at the depth of the shallow sensor, and the minimal response of the deep sensor to precipitation (as will be discussed subsequently) suggest evapotranspiration is affecting subsurface water movement. More precipitation was required to raise moisture contents at the 3.5-ft depth in early August than in September. During mid-summer the soils were depleted of much of their moisture by lack of precipitation and high rates of evapotranspiration. By late September, evapotranspiration appears to have less effect on sensor response and on limiting infiltration.

Minimal infiltration seems to occur through the fine-grained soils to depths greater than about 6 ft, assuming that all deep sensors were functioning properly into mid-July. VMC's appeared to increase steadily over the recording period by about $0.02 \text{ m}^3/\text{m}^3$, but no obvious sensor response to any large individual or clustered precipitation events was observed. The only possible indication of deep infiltration is a slight (less than $0.01 \text{ m}^3/\text{m}^3$) increase in VMC as recorded by the sensor at the northern study site in early September (fig. 7). If the sensor reading represents an actual increase in moisture content, the increase possibly is a response to the multiple 1-in. storms that occurred in early August (fig. 7). This response would suggest a travel time for the wetting front of about 0.08 ft/d through the sub-root-zone soils.

Data from the UZ piezometers provide qualitative insight into the potential for deep infiltration at the study sites. However, interpretation of the data is limited by the fact that

the piezometers were not regularly evacuated between visits. Furthermore, it is possible that direct drainage into some piezometers occurred when their flush-mounted surface vaults flooded during several large, early spring storms. Preferential flow down the installation annulus also may have occurred prior to full hydration of the bentonite seal. At the first measurement in early June, the 1-ft basal traps of the shallow piezometers at the southern site and northern near-river site (fig. 3) were filled fully with water. Prior to that time there had been more than 5 in. of precipitation at both sites, including 1.5- and 2.5- in. storms about 1 month earlier. In mid-July, about one week after the piezometer had been pumped dry, about 0.1 ft of water was measured in the shallow piezometer at the southern site. Similarly, about 0.9 ft of water was measured in the shallow piezometer at the northern near-river site in late October, about 3 months after the piezometer had been pumped dry. Precipitation totals during these periods were 0.6 in. and 14.5 in., respectively. No drainage to the shallow piezometer at the northern west site was recorded. These observations indicate water can infiltrate through the fine-grained soils to depths of at least 4 ft. The infiltration seemed to occur primarily during late spring and mid-fall, when there is available water for drainage as the result of seasonally high precipitation rates and low evapotranspiration rates. The UZ piezometer data also suggest that infiltration varies spatially, most likely because of variability in soil texture. Drainage to the shallow piezometers seems to be limited to the finer-grained soils at the southern and northern near-river sites. The clay-rich soils tend to inhibit vertical flow, allowing the soil moisture to increase to levels that induce flow into the piezometers. The presumably more permeable soils of the northern west site, along with the comparatively thin fine-grained horizon (about 7.5 ft) at this site, probably allow for more rapid drainage, thus limiting flow into the piezometer.

With one possible exception, no flow was recorded into the deep UZ piezometers. In mid-June, 0.04 ft of water was measured in the piezometer open to the depths of 13-15 ft. However, installation of this piezometer was problematic because of a moist zone at that time near the 6 ft depth. The annulus likely was filled with bentonite only to a depth of

DELTA GROUNDWATER

about 6 ft. The recorded drainage to the piezometer is considered unrepresentative of ambient flow conditions at that depth. One possible explanation for the absence of water in the deep UZ piezometers is minimal deep infiltration through these fine-grained soils.

Available ground-water data collected from March through October 2006 at and near the various unsaturated-zone instrument clusters is insufficient for definitive analysis of the potential for deep infiltration and ground-water recharge from precipitation. Periodically measured ground-water levels indicate water levels fluctuate seasonally and in response to selected precipitation events. However, the lack of continuous monitoring makes it difficult to discern if the levels are responding to changes in stream stage or direct recharge from the overlying unsaturated zone. Available data from the deep soil-moisture sensors and UZ piezometers suggest the rise in ground-water levels is associated primarily with rises in stage in the nearby Bogue Phalia River. This is most evident from the continuously collected ground-water-levels at the northern near-river site, as previously discussed. Thus, the river seems to be hydraulically connected to the aquifer and suggests that the river may be an important source of recharge.

Additional Data Collection and Analysis

From the initial period of study during spring through fall 2006, data gaps and instrument needs were identified. In January 2007, additional soil-moisture sensors were installed at the three instrument clusters. Modifications in the installation method, advances in sensor design, and more typical climatic conditions hopefully will result in the newly installed sensors outperforming their predecessors. Newly installed shallow sensors were positioned about one foot deeper than their predecessors to assure that they were below the zero-flux plane, thus, isolated from evapotranspiration effects. With one exception, 2-in. model sensors replaced the original 4-in. sensors (fig. 4). The replacement sensors operate at a higher frequency (70 MHz) than their predecessors (5MHz). This should improve measurement accuracy within a wider range of soil textures (including sand) and allow measurement of VMC's over a wider range (0-100%).

The smaller size of the replacement sensors also eases their installation, thus reducing the likelihood of installation-related damage to the sensors.

Along with installation of the replacement sensors, core samples were collected at each of the installation depths for measurement of VMC. These time-synchronous moisture contents will serve as an additional check of sensor accuracy. Finally, particle-size distribution will be determined on selected cores from each of the study sites. This analysis hopefully will provide better delineation of variations in soil texture with depth and between study sites; subsurface water movement is affected, in part, by soil texture.

Future data-collection plans include addressing shortcomings associated with monitoring the UZ piezometers. These instruments seemingly can provide useful information regarding infiltration through the unsaturated zone. To provide accurate information, they must be regularly evacuated of standing water and their sealing caps must be watertight.

It is recognized that the majority of the available data were collected during a period of limited precipitation. The instruments were installed in mid-spring, the seasonal period when most precipitation occurs and most ground-water recharge is expected. During this time, the newly installed instruments seemed, for the most part, to be equilibrating with the subsurface settings that were perturbed by their installation. During the summer months that followed, precipitation was about 60-75% of normal. It is anticipated that data collection during spring 2007 will provide additional insight into the potential for deep infiltration; the wide array of instruments installed between spring 2006 and winter 2007 should be fully equilibrated with the surrounding subsurface conditions and many of the questionably performing instruments have been replaced with technically advanced models.

Conclusions

Initial data obtained during spring through fall 2006 from the two study sites in the Bogue Phalia River Basin, Miss., provided (1) insights regarding the performance and utility of the various monitoring instruments employed and types of data collected for this unsaturated-zone infiltration

Potential for infiltration through the fine-grained surficial deposits of the Bogue Phalia Watershed, Mississippi Mills, et al

study, and (2) the basis for a preliminary conceptual model of the potential for deep infiltration through the fine-grained soils of the basin. Although the performance of the soil-moisture sensors satisfied many of the data-quality objectives of this study, there are remaining questions regarding their utility to the study that necessitate their continued evaluation. When performing optimally, the sensors provided acceptably representative measurements of soil-moisture content. The present soil-physical-property, soil-moisture, and ground-water data suggest only minor amounts of precipitation infiltrate below the approximate depth of the root zone (about 4 ft) in the fine-grained soils of the basin. Soil texture appears to account, in part, for the seemingly greater potential for deep infiltration in the northern part of the basin compared to the southern part. In general, the northern soils are more coarse grained. During spring and fall months, ground-water levels and stream stage responded similarly after large precipitation events (exceeding about 1 in.), indicating that the aquifer and river most likely are hydraulically connected. Thus, the river may be an important source of aquifer recharge.

The additional data from technically advanced soil-moisture sensors installed during January 2007 and the soil-texture analyses of cores collected at each of the study sites hopefully will improve understanding of the potential for deep infiltration and allow quantification of water flux through the fine-grained soils of the Bogue Phalia River Basin. This information, along with water-chemistry and continuously monitored water-level and temperature data from an associated network of streambed and ground-water piezometers, and analyses of the basin's shallow ground water and streams for agricultural chemicals, hopefully will advance understanding of the factors that may account for the presence (or absence) of agricultural chemicals in ground waters of the basin.

References

Arthur, J.K, 2001, Hydrogeology, model description, and flow analysis of the Mississippi River alluvial aquifer: U.S. Geological Survey Water-Resources Investigations Report 01-4035, 47 p.

Campbell, C.S., 2001, Response of the ECH2O soil moisture probe to variation in water content, soil type, and solution electrical conductivity: Decagon Devices, Inc.: accessed February 13, 2007 at URL http://www.decagon.com/appnotes/echo_analysis.pdf

Cobos, D.R., 2007, Calibrating ECH2O soil moisture sensors: Decagon Devices, Inc.: accessed February 13, 2007 at URL <http://www.decagon.com/appnotes/echocal.pdf>

Decagon Devices, Inc., 2006, ECH2O Soil moisture sensor, Operator's manual: accessed February 13, 2007 at URL <http://www.decagon.com/manuals/echomanual.pdf>

Decagon Devices, Inc., 2007, ECH2O soil moisture probes: theory: accessed February 13, 2007 at URL <http://www.decagon.com/echo/theory.html>

Erwin, M.L., Coupe, R.H., and Capel, P.D., 2005, Bogue Phalia watershed in Mississippi selected for a National water-quality study: U.S. Geological Survey Fact Sheet 2005-3050, 2 p.

Gonthier, G.J., 2003, Quality of ground water in Pleistocene and Holocene subunits of the Mississippi River Valley alluvial aquifer, 1998: U.S. Geological Survey Water-Resources Investigations Report 03-4202, 80 p.

Krinitzky, E.L., and Wire, J.C., 1964, Ground water in the alluvium of the lower Mississippi valley (upper and central areas): U.S. Army Corps of Engineers Waterways Experiment Station, TR3-658, v. 1, 2,400 p.

National Weather Service, 2007a, Jackson, Ms. Forecast Office, Climatological Data, Stoneville Experimental Station, Ms.: accessed February 23, 2007 at URL http://www.srh.noaa.gov/jan/climate/climate_stonevilleexpstn.htm

National Weather Service, 2007b, Jackson, Ms. Forecast Office, Climatological Data, Rosedale, Ms.: accessed

DELTA GROUNDWATER

February 23, 2007 at URL http://www.srh.noaa.gov/jan/climate/climate_rosedale.htm

Office of Pollution Control, 2004, Mississippi agricultural chemical groundwater monitoring program, March 1, 1989–December 31, 2004: Mississippi Department of Environmental Quality, 41 p.

Rose, C.E., 2007, Determining the potential for direct recharge in the Mississippi River Alluvial Aquifer using soil core analyses, Washington County, Northwest Mississippi: Jackson, Miss., Millsaps College, unpublished honors thesis, 22 p.

Sumner, D.M., and Wasson, B.E., 1990, Geohydrology and simulated effects of large ground-water withdrawals on the Mississippi River alluvial aquifer in northwestern Mississippi: U.S. Geological Survey Water-Supply Paper 2292, 60 p.

U.S. Department of Agriculture, 2006a, Agricultural chemical usage: 2005 field crops summary: accessed February 20, 2007 at URL <http://usda.mannlib.cornell.edu/usda/nass/AgriChemUsFC//2000s/2006/AgriChemUsFC-05-17-2006.pdf>

U.S. Department of Agriculture, 2006b, Natural Resources Conservation Service, Web soil survey, Washington County, Mississippi: accessed November 11, 2006 at URL <http://websoilsurvey.nrcs.usda.gov/app/WebSoilSurvey.aspx>

The use of firm, trade, and brand names in this report is for identification purposes only and does not constitute endorsement by the U.S. Government.

DELTA GROUNDWATER

Mississippi River Valley Alluvial Aquifer Geology of the Central Delta (East Central Sunflower County and West Central Leflore County)

Charlotte Bryant Byrd
Office of Land and Water Resources
P.O. Box 10631
Jackson, MS 39289-0631
601-961-5216
Email: charlotte_bryant_byrd@deq.state.ms.us

ABSTRACT

The Mississippi River valley alluvial aquifer (MRVA) underlies the alluvial plain in northwestern Mississippi, an area commonly known as the Delta. This very prolific aquifer is the most intensely developed source of groundwater in Mississippi, and is used mostly for irrigation and catfish culture. Probably one of the most intensely developed areas within the Delta is East Central Sunflower County and West Central Leflore County where most of the alluvial wells are used for rice and catfish. As a result of the intense use of groundwater from the MRVA in this area, water levels have declined more rapidly than water levels from the surrounding Delta area.

Considering the tremendous importance of this aquifer to the economic viability of agriculture in the Delta, understanding the geology of the MRVA, along with water level trends, is imperative for proper planning and management of this water resource.

Since the fall of 1980, water levels from wells screened in the alluvial aquifer Delta-wide have been collected twice each year. The number of wells in this project, called the semi-annual survey, has varied from approximately 300 to currently over 500. Staff of the MDEQ's Office of Land and Water Resources has been involved in an ongoing drilling project to determine the remaining amount of saturated thickness within the alluvial aquifer. Stratigraphic holes have been drilled near several of these wells to determine the geology, including the depth of the base of the MRVA, the thickness of the surficial clay, the physical characteristics of the saturated portion of the aquifer, as well as whether or not the MRVA is connected to an underlying aquifer.

Future drilling sites include southeast Bolivar County, north Sunflower County, and west Leflore County adjacent to the Tallahatchie River.

Keywords:

DELTA GROUNDWATER

Mississippi River Floodplain "Delta" - Bluff Margin Alluvial Fan Complexes

James E. Starnes and John C. Marble
Mississippi Office of Geology
Mississippi Department of Environmental Quality
P.O. Box 20307
Jackson, MS 39289-1307
601-961-5544

ABSTRACT

Lateral migration of the Mississippi River into the river's east valley wall creates an escarpment of Peorian loess (often thick), Early Pleistocene Pre-loess terrace deposits (coarse sand and gravels of the ancestral Mississippi River), and underlying Tertiary formations (which commonly form the toe of the escarpment). As the river migrates westward from the escarpment, the trunks of dendritic drainage systems must cross an alluvial plain of low relief. Alluvial fans develop where the stream trunk enters into the "Delta" as these streams lose their energy and therefore their bed load. These fans owe their size to the extensiveness of their watersheds and are fed by an unconsolidated sedimentary section with a high susceptibility to erosion and where mass wasting events such as failures in the loess are commonplace. The streams receive spring water in their upper reaches from a loess/terrace and Tertiary bedrock where the lithologies permit. The trunk of the stream recharges the alluvial fan (or fan complexes where neighboring fans inter-finger) and possibly even the Mississippi River alluvial aquifer where the alluvial fan and the river alluvium inter-finger. Unlike much of the Mississippi River alluvium the "Delta"-bluff margin alluvial fans may receive recharge from surface waters over parts of the fan. The thickest accumulation of coarse-grained sediments is near the apex of the fan and this may be a local source of groundwater for agricultural irrigation or domestic wells. The fans are elevated above the flood plain surface and are associated with running water, and therefore, they commonly contain large, well-preserved, often multi-component, archaeological deposits.

Keywords:



MODELING



Evaluation of HSPF Streamflow Uncertainty Bounds Due to Potential Evapotranspiration Bias and Parameter Variability

J. N. Diaz, W. H. McAnally, and J. L. Martin
Department of Civil and Environmental Engineering, Mississippi State University

Spatial distribution of land cover and their influences on watershed condition

Peter E. Schweizer and Glenn R. Matlack
Environmental and Plant Biology, Ohio University

Pesticide Runoff from Bermudagrass: Effects of Plot Size and Mowing Height

Peter A. Ampim, J. H. Massey, B. R. Stewart, M. C. Smith, K. L. Armbrust, A. B. Johnson and A. A. Andrews
Department of Plant and Soil Sciences, Mississippi State University

Modeling Mobile Bay Sediments and Pollutants with New Technologies

William H. McAnally, James L. Martin, Mary Love Tagert and Jeremy Sharp
Department of Civil and Environmental Engineering, Mississippi State University

Integration of Impact Factors of Gas-Liquid Transfer Rate

Zhiyong Duan and James L. Martin
Department of Civil and Environmental Engineering, Mississippi State University

Activities of the U.S. Geological Survey Related to Total Nitrogen and Total Phosphorus Trends and Modeling in Surface Waters of the Lower Mississippi and Texas-Gulf River Basins

Richard A. Rebich
U.S. Geological Survey, Mississippi Water Science Center

Evaluation of HSPF Streamflow Uncertainty Bounds Due to Potential Evapotranspiration Bias and Parameter Variability

J. N. Diaz, W. H. McAnally, and J. L. Martin
Department of Civil and Environmental Engineering
Mississippi State University
Box 9546
Mississippi State, MS 39762
662-325-1452
E-mail: jd216@mssstate.edu

ABSTRACT

The Hydrologic Simulation Program – FORTRAN (HSPF) is used to develop Total Maximum Daily Loads (TMDLs). Watershed models are defined by input time series (e.g., precipitation, evaporation, etc), physical characteristics of the area (e.g., size, slope, land use, etc), and algorithms. Approximations of real environments using models are a good alternative to reduce costs and save time; however modelers are faced with various uncertainties in input and output data, model parameters, and model structure due to lack of knowledge and/or random variability of the processes. Quantification of uncertainty should be considered in TMDL models. Probabilistic point estimation methods propagate the parameter uncertainty by performing point estimations of the parameter space instead of calculating the entire probability density function (PDF). The objective of this study is to evaluate potential evapotranspiration and parameter uncertainty propagation on simulated flows using the Harr's probabilistic point estimate method. This work attempts to model daily flows using the HSPF model and uncertainty bounds for a watershed in Alabama and Mississippi. Uncertainty bounds for daily streamflows are generated using the 5th and 95th percentiles of simulated flows. Twelve HSPF parameters and +/- 5%, +/-10%, +/-20%, +/-30%, +/-40% and +/-50% of potential evapotranspiration data are evaluated. Observed daily streamflow data from 01/01/2001 to 11/30/2004 are used to evaluate the HSPF uncertainty bounds. From the bounds constructed using parameter uncertainty for the evaluated period, the observed streamflow data are 77% within the 90% certainty bounds. The model is more sensitive to lower potential evapotranspiration linear bias than higher values.

Keywords: Hydrology, models, surface water

Spatial distribution of land cover and their influences on watershed condition

Peter E. Schweizer and Glenn R. Matlack
Environmental and Plant Biology
Ohio University
Porter Hall 405
Athens, OH 45701
740-593-1131
E-mail: ps128502@ohio.edu

ABSTRACT

Using competing spatial models we examined the influence of spatial distribution of land cover on watershed condition for headwater and small-order streams in Forrest and Lamar County, MS. Land cover analysis utilized multi-spectral aerial photography, Landsat5 data, National Agriculture Imagery Program (NAIP) images, and GIS to evaluate contribution of spatial extent and position of land cover type within catchments on water quality, stream geomorphology and fish assemblages. Land cover distribution varied between watersheds. Land cover analysis identified forest vegetation as dominant element within the landscape matrix. Total variation in water quality was greater among catchments with different land cover type than within catchments with similar land cover. At the catchment scale the spatial extent of total forest cover was the best predictor of watershed condition. Impervious surfaces, transient land cover, and managed green areas were correlated to stream hydrology, creek bed geomorphology and sediment transport, with impervious surface cover and managed green areas as strongest influences on stream conditions at the reach scale. Fish assemblages varied in their composition. Urbanized catchments showed pauperized species diversity with an increase in cosmopolitan species compared to watersheds with a dominant rural or forest land cover. Results of the study indicate that not only the spatial extent of land cover type but also their explicit spatial distribution within the catchment influence watershed condition.

Keywords: Models, water quality, surface water, sediments, ecology

Pesticide Runoff from Bermudagrass: Effects of Plot Size and Mowing Height

P. A. Ampim, J. H. Massey, B. R. Stewart, M. C. Smith, K. L. Armbrust, A. B. Johnson and A. A. Andrews
Department of Plant and Soil Sciences
P. O. Box 9555
Mississippi State University
Mississippi State MS, 39762
662-617 3645
E-mail: paa24@pss.msstate.edu

ABSTRACT

Improved prediction of environmental concentrations of pesticides in the urban environment involves understanding factors that affect their transport. We investigated the effects of plot size and mowing height on pesticide runoff from Mississippi Pride bermudagrass (*Cynodon dactylon* [L] Pers. x *Cynodon transvalensis* Burt-Davy) maintained as golf course fairways and residential lawns. The fairway and homelawn treatments were cut at 1.3 cm and 5 cm respectively. The study was conducted on a hydrologic class D Brooksville silty clay soil (fine montmorillonitic, thermic Aquic Chromudert). The four plot sizes investigated were 1.8 x 1.8 m, 3.7 x 9.1 m, 6.1 x 24.4 m and 12.2 x 38.1 m. The plots had 3 % slope with minimal cross slope. The experimental design was a randomized complete block design with split plot arrangement of treatments. The main plot factor was plot size while the sub-plot factor was mowing height (1.3 and 5.0 cm). Following a standardized protocol, the dimethylamine salt of 2, 4-D herbicide, flutolanil fungicide and chlorpyrifos insecticide were co-applied at 1.12 kg ai/ha, 2.24 kg ai/ha and 2.24 kg ai/ha, respectively. A conservative tracer (KBr) was also applied separately at 15 kg/ha to allow tracking of water movement in the turfgrass system. Simulated rainfall was applied at 38.1 mm/h to the plots 24 h after pesticide application. Pesticide concentrations in runoff and application monitors were analyzed by a high performance liquid chromatography using UV-Vis detection. The limit of quantification for the three pesticides was approximately 10 ppb. Plot size and grass mowing height effects on pesticide runoff and several hydrological parameters will be discussed.

Keywords: Models, Nonpoint Source Pollution, Surface Water, Water Quality

Modeling Mobile Bay Sediments and Pollutants with New Technologies

William H. McAnally, James L. Martin, Mary Love Tagert and Jeremy Sharp
Department of Civil and Environmental Engineering
Mississippi State University
662-325-9848
E-mail: mcanally@cee.msstate.edu

ABSTRACT

The overall goal of this new investigation is to provide insight into the flow of sediment and specific associated pollutants in the Mobile Basin and similar coastal basins so that resource management decisions can be made in an informed manner and the Basin's environmental quality improved.

The work will develop a management-oriented model of sediment, mercury, and dichlorodiphenyltrichloroethane (DDT) for Mobile Bay and the major tributaries to the Bay. The study will first synthesize available data in order to obtain mass budget estimates for water and sediments. Numerical models previously applied to the system will be refocused, and/or converted, to simulation of sediment, DDT and mercury. The models, along with available data and data analysis tools, will be used in the assessment of factors impacting the fate and transport of mercury and DDT in the Basin. Estimates will be made, wherever possible, as to the uncertainty of assessments based upon data and/or model results. Estimating uncertainties is of particular importance since, for example, some of the processes impacting the transformations of mercury, such as methylation, are poorly understood and quantified. The available data and model predictions will be used to evaluate potential management strategies (e.g. no action and action alternatives) using a weight of evidence approach. The modeling and data analysis tools will also provide a basis for a "living model" of the Basin that can be updated to address other management questions as they arise. Work to date has consisted of compiling and analyzing data from Mobile Bay and set-up of transport models.

Keywords: Models, Nonpoint Source Pollution, Sediments, Surface Water

Integration of Impact Factors of Gas-Liquid Transfer Rate

Zhiyong Duan and James L. Martin
Department of Civil Engineering
Mississippi State University
P.O. Box 9546
Mississippi State, MS 39762-9546
662-325-2902
E-mail: zd9@msstate.edu

ABSTRACT

The gas transfer rate at air-water interface (reaeration rate) has significant impact on surface water quality. The gas transfer rate is affected by multiple factors including stream, wind, wave breaking, etc. When wind is blowing over water, the turbulence generated at the air-water interface is the predominant factor impacting reaeration. A number of empirical relationships have been established for the gas transfer rate as a function of wind speed. A theoretical model of the wind reaeration rate has also been developed by O'Connor. However, in addition to wind-induced turbulence in an "unbroken" water surface, wave breaking is predominant factor impacting reaeration in the "broken" water surface, where the reaeration is driven by the bubble-mediated gas transfer. In this paper, a relationship is developed to integrate the effects of wave breaking and wind on the rate of reaeration.

Keywords: Models, Surface Water, Water Quality

Introduction

The distribution of the constituents in aquatic ecosystems is significantly affected by the transfer of sparingly soluble gases such as dissolved oxygen across the air-water interface. Many factors such as wind, wave breaking, bubbles, etc. affect the gas-liquid transfer rate. Some studies (Broecker et al. 1978; Jahne et al. 1979; Liss and Merlivat 1986; Wanninkhof 1992; Wanninkhof and McGillis 1999) have focused on the effects of wind; some studies (Boettcher et al. 2000; Peirson et al. 2003; Woolf 1997; Zappa 2001) on the effects of wave breaking; and some other studies (Broecker and Siems 1984; Eckenfelder 1959; Memery and Merlivat 1983; Thorpe 1982 and 1986; Woolf and Thorpe 1991) on the effects of bubble-mediated gas-liquid transfer rate. Only a few studies (Asher and Farley 1995) were on

the combined effects of wind, wave breaking and bubbles, in which basically empirical formulae were used for the calculation of the total gas-liquid transfer rate. In this study, an integrated gas-liquid transfer rate formula is developed, in which the majority components are theoretical. It will have wider application ranges as its majority is theoretical.

Wind-driven gas-liquid transfer rate

Wind has significant effects on gas-liquid transfer rate in many water bodies such as estuaries, lakes, oceans, etc. A theoretical wind-stream-driven gas-liquid transfer rate has been developed (Duan et al. 2007). It incorporates the combined effects of both wind and stream on gas-liquid transfer rate. By setting the stream velocity to be zero, a theoretical wind-driven gas-liquid transfer rate formula was obtained

(Duan and Martin 2007) as:

$$\text{when } 0 \leq n_1 \leq \left(\frac{g\nu}{\lambda\alpha} \right)^{1/2} \quad (1)$$

$$K_L = \frac{1}{\left(\frac{\Gamma - 1}{\lambda} \right)^2 + \sqrt{\frac{121.5\nu}{D \frac{\rho_a C_{11}}{\rho_a} 2}} + \sqrt{\frac{121.5\nu}{D \frac{\rho_a C_{11}}{\rho_a} 2}}} W - C_1 W$$

$$\text{when } \left(\frac{g\nu}{\lambda\alpha} \right)^{1/2} \leq n_1 \leq \left(\frac{\Gamma g\nu}{\alpha} \right)^{1/2}$$

$$K_L = \frac{1}{\left(\frac{\Gamma\nu}{D \sqrt{\frac{\rho_a C_{11}}{\rho_a} 2}} + \sqrt{\frac{121.5\nu}{D \frac{\rho_a C_{11}}{\rho_a} 2}} \right) W^{-1} - \frac{\alpha \frac{\rho_a C_{11}}{\rho_a} 2}{Dg} W^{-2}} = \frac{1}{C_{21} W^{-1} + C_{22} W^{-2}}$$

$$\text{when } n_1 \geq \left(\frac{\Gamma g\nu}{\alpha} \right)^{1/2}$$

$$K_L = \sqrt{\frac{D \frac{\rho_a C_{11}}{\rho_a} 2}{121.5\nu}} W - C_3 W$$

where C_1 = coefficient of wind-driven gas-liquid transfer rate in segment 1; C_{21} , C_{22} = coefficient of wind-driven gas-liquid transfer rate in segment 2; and C_3 = coefficient of wind-driven gas-liquid transfer rate in segment 3. The wind-driven gas-liquid transfer rate formula is reasonable as a specific case of the wind-stream-driven gas-liquid transfer rate formula which has been successfully tested. In this study, the wind-driven gas-liquid transfer rate formula is considered as applicable for non-breaking wave gas-liquid transfer rate.

Wave breaking gas-liquid transfer rate

When wind speed is large enough and wave breaking occurs, the gas-liquid transfer rate is significantly increased. The gas transfer dominated by breaking wave is proportional to fractional whitecap coverage. The coefficient is based on the calculations of bubble-mediated transfer, and therefore depends on the solubility of the gas. A simple formula, ap-

propriate for CO_2 at 20°C , is given by (Woolf 1997):

$$K_L = 850W \quad (2)$$

where K_L = gas-liquid transfer rate induced by breaking wave in cm/hr; W = wind speed, m/s.

Different research areas focus on the gas-liquid transfer processes of different gases; e.g. dissolved oxygen is the major concern in environmental engineering and carbon dioxide is the major concern in oceanography. The similarity of the transfer processes of different low solubility gases allows the conversion of transfer rates among different low solubility gases. The related conversion relationships are described with Schmidt number:

$$K_{La} = K_{Lb} \left(\frac{Sc_a}{Sc_b} \right)^x \quad (3)$$

where K_{La} = gas-liquid transfer rate of gas a, m/s; K_{Lb} = gas-liquid transfer rate of gas b, m/s; Sc_a = Schmidt number of gas a; Sc_b = Schmidt number of gas b; and x = Schmidt number dependence that is $-2/3$ for smooth surfaces and $-1/2$ for rough surfaces (Donelan, et al. 2001). The Schmidt number (Sc) is a dimensionless number which equals to ν/D , with ν as kinematic viscosity, a property of the material. The Schmidt number is used to characterize fluid flows with convection processes caused by simultaneous momentum and mass diffusion (Munson, 1994).

With this relationship, the transfer rates of different gases including oxygen, carbon dioxide, PCBs, etc. are related. With the transfer rate of one gas, the rates of other gases can be calculated by this relationship. Thus, Substitution of Eq.2 into Eq.3 yields the wave breaking gas-liquid transfer rate for dissolved oxygen as:

$$K_{Lbw} = 850W \left(\frac{Sc_a}{Sc_b} \right)^x = C_{bw} W \quad (4)$$

where K_{Lbw} = breaking wave gas-liquid transfer rate, m/s; and C_{bw} = coefficient of breaking wave gas-liquid transfer rate.

Bubble-mediated gas-liquid transfer rate

Bubble-mediated gas transfer is an important part of the total gas transfer especially during wave breaking, droplets, etc. It was reported that dissolved oxygen will be supersaturated by deep bubble clouds (Thorpe 1982 and 1986; Woolf and Thorpe 1991). The breaking waves entrain bubbles at high wind speeds, which increase the gas-liquid transfer rate (Memery and Merlivat, 1983; Broecker and Siems, 1984). The bubbles entrained by breaking waves were observed to greatly enhance the gas-liquid transfer rate (Farmer et al. 1993). But some studies indicated that the bubble-mediated gas transfer was at most 7% of the total gas transfer in wind-driven turbulence (Komori and Misumi 2001).

Eckenfelder (1959) described the oxygen transfer in terms of Sherwood number, Reynolds number and Schmidt number:

$$\frac{K_L d_b}{D} = F \left(\frac{d_b U_b}{\nu} \right) \left(\frac{\nu}{D} \right) \quad (5)$$

where U_b = bubble velocity, m/s; ν = kinematic viscosity, m^2/s ; $K_L d_b / D$ = Sherwood number (Sh); $d_b u / \nu$ = Reynolds

number (Re); ν / D = Schmidt number (Sc); and F = bubble-mediated gas-liquid transfer rate constant coefficient.

Integration of impact factors of gas-liquid transfer rate

Asher and Farley (1995) showed that gas-liquid transfer rate K_L could be partitioned into several components: near-surface turbulence generated by currents and non-breaking wave (K_{Lnw}), turbulence generated by breaking waves (K_{Lbw}), and bubble-mediated transfer (K_{Lb}). If the gas concentration grade is large, the total gas-liquid transfer rate is given by:

where W_c = fractional area of whitecap whitecap coverage.

$$K_L = [K_{Lnr} + W_c(K_{Lbw} - K_{Lnr})] + W_c K_{Lb} \quad (6)$$

In this study, Eq.1 is used for the calculation of K_{Lnw} ; Eq.4 is used for the calculation of K_{Lbw} ; and Eq.5 is used for the calculation of K_{Lb} . Substitution of Eq.1, Eq.4 and Eq.5 into Eq.6 yields the integrated gas-liquid transfer rate for the combined effects of wind, wave breaking, and bubbles as Eq.7-10 (Eq.10 has three segments) show:

$$K_L = (K_{L_{nw}} + Wc(K_{L_{bw}} - K_{L_{nw}})) + WcK_{L_b} \quad (7)$$

$$\frac{K_{L_b} d_B}{D} = F\left(\frac{d_B U_B}{\nu}\right) \left(\frac{\nu}{D}\right) \quad (8)$$

$$K_{L_{bw}} = C_{bw} W \quad (9)$$

$$(10)$$

$$0 \leq u_* \leq \left(\frac{g\nu}{\lambda_y \alpha}\right)^{\frac{1}{3}}$$

$$K_L = \frac{1}{\left(\frac{\Gamma - \frac{1}{\lambda_y}}{\nu}\right) + \sqrt{\frac{121.5\nu}{D \frac{\rho_a C_{fl}}{\rho_w 2}}}} W = C_1 W$$

$$\left(\frac{g\nu}{\lambda_y \alpha}\right)^{\frac{1}{3}} \leq u_* \leq \left(\frac{1'g\nu}{\alpha}\right)^{\frac{1}{3}}$$

$$K_L = \frac{1}{\left(\frac{\Gamma \nu}{D \sqrt{\frac{\rho_a C_{fl}}{\rho_w 2}}}\right) + \sqrt{\frac{121.5\nu}{D \frac{\rho_a C_{fl}}{\rho_w 2}}}} W^{-1} - \frac{\alpha \frac{\rho_a C_{fl}}{\rho_w 2}}{Dg} W^2 = \frac{1}{C_{21} W^{-1} + C_{22} W^2}$$

$$u_* \geq \left(\frac{\Gamma g\nu}{\alpha}\right)^{\frac{1}{3}}$$

$$K_L = \sqrt{\frac{D \frac{\rho_a C_{fl}}{\rho_w 2}}{121.5\nu}} W = C_3 W$$

Conclusions

An integrated gas-liquid transfer rate formula was developed in this study for the combined effects of wind, wave breaking and bubbles. The wind-driven gas-liquid transfer rate formula was used for the calculation of the non-breaking wave component $K_{L_{nw}}$. A breaking wave gas-liquid transfer rate formula was developed for the calculation of the breaking wave component $K_{L_{bw}}$. The bubble-mediated gas-liquid transfer rate formula developed by Eckenfelder (1959) was used for the calculation of the bubble-mediated component K_{L_b} . All of the components except the wave breaking one are theoretical formulae. Thus, the integrated gas-liquid transfer

rate formula has wide application ranges since its majority is theoretical. For further study, a theoretical wave breaking gas-liquid transfer rate formula needs to be developed. The experimental data for the combined effects of wind, wave breaking and bubbles need to be conducted to test the integrated gas-liquid transfer rate formula.

Acknowledgements

The writers thank Dr. Dennis D. Truax, Dr. William H. McAnally, Dr. Richard L. Stockstill, and Dr. David H. Bridges. Financial support is provided by a research grant from Kelly Gene Cook, Sr. Endowment at Mississippi State University.

References

- Asher, W. E., and Farley, P. J. (1995). "Phase-Doppler anemometer measurement of bubble concentrations in laboratory-simulated breaking waves", *J. Geophys. Res.*, 100C: 7045-7056.
- Broecker, H. C., Petermann, J., and Siems, W. (1978). "The influence of wind on CO₂-exchange in a wind-wave tunnel, including the effects of monolayers." *J. Marine Res.*, 36, 595-610.
- Boettcher, E. J., Fineberg, J., and Lathrop, D. P. (2000). "Turbulence and Wave Breaking Effects on Air-Water gas transfer." *Physical Review Letters*, 85, 2030-2033.
- Broecker, H. C. and Siems, W. (1984). "The role of bubbles for gas transfer from water to air at higher windspeeds. Experiments in the wind-wave facility in Hamburg." *Proc., Gas Transfer at Water Surfaces*, Kluwer Academic Publishers, Dordrecht, Holland, 229-236.
- Duan, Z., Martin, J. L., McAnally, W. H., and Stockstill, R. L. (2007). "Combined effects of Wind and Stream on Gas-liquid Transfer Rate." Under preparation.
- Duan, Z. and Martin, J. L. (2007). "Gas-liquid transfer rate in wind-driven systems." Under preparation.
- Eckenfelder W. W. (1959). "Factors affecting the aeration efficiency." *Sewage ind. Wastes*, 31, 61-70.
- Jahne, R., Munnich, K.O., and Siegeuthaler, U. (1979). "Measurements of gas exchange and momentum transfer in a circular wind-water tunnel." *Tellus*, 31, 321.
- Liss, P. S., Merlivat, L. (1986). "Air-sea gas exchange rates: introduction and synthesis". *Proc., The Role of Air-Sea Exchange in Geochemical Cycling*, Norwell, MA, 113-129.
- Memery, L., and Merlivat, L. (1983). "Gas exchange across an air-water interface: experimental results and modelling of bubble contribution to transfer." *J. Geophys. Res.*, 88, 707-724.
- Peirson, W. L., and Banner, M. L. (2003). "Aqueous surface layer flows induced by micro-breaking wind waves." *J. Fluid Mech.*, 479, 1-38.
- Thorpe, S. A. (1982). "On the clouds of bubbles formed by breaking wind-waves in deep water, and their role in air-sea gas transfer." *Phil. Trans. R. Soc., London*, A304, 155-210.
- Wanninkhof, R. (1992). "Relationship between wind speed and gas exchange over the ocean." *J. Geophys. Res.*, 97, 7373-7382.
- Wanninkhof, R. H., and McGillis, W. R. (1999). "A cubic relationship between air-sea CO₂ exchange and gas speed." *Geophys. Res. Lett.*, 26, 1889-1892.
- Wolf, D. K. (1997). "Bubbles and their role in gas exchange." *Proc., The Sea Surface and Global Change* (Liss, P. S., and Duce, R. A., eds), Cambridge University Press, Cambridge, 173-205.
- Wolf, D. K. and Thorpe, S. A. (1991). "Bubbles and the air-sea exchange of gases in near-saturation conditions." *J. Mar. Res.*, 49, 435-466.
- Zappa, C. J., Asher, W. E., and Jessup, A. T. (2001). "Microscale wave breaking and air-water gas transfer." *J. Geophys. Res.*, 106(C5), 9385-9392.

Activities of the U.S. Geological Survey Related to Total Nitrogen and Total Phosphorus Trends and Modeling in Surface Waters of the Lower Mississippi and Texas-Gulf River Basins

Richard A. Rebich
U.S. Geological Survey, Mississippi Water Science Center
308 South Airport Road
Jackson, MS 39208-6649
601-933-2928
E-mail: rarebich@usgs.gov

ABSTRACT

The U.S. Geological Survey recently completed an assessment of trends in total nitrogen and total phosphorus concentrations and loads for the period 1993-2004 for surface waters in the Lower Mississippi (including the Arkansas-White-Red) and the Texas-Gulf River Basins. This assessment was part of a national effort to complete similar trend analyses for eight different regions in the United States as part of the U.S. Geological Survey National Water-Quality Assessment Program. Preliminary results indicated few trends in total nitrogen and total phosphorus data and no regional patterns where trends were observed during the study period. Decreasing trends in total nitrogen likely were an artifact of decreasing trends in flow. Increasing trends in total nitrogen were attributed to point source discharges (that have not been improved) and to areas where animal feeding operations (poultry and cattle) increased during the past decade. Decreasing trends in total phosphorus were attributed primarily to improvements in point source discharges, such as installation of advanced treatment facilities. Most of the increasing trends in total phosphorus were attributed to point sources (that have not been improved) and to animal feeding operations (poultry, swine, and cattle), similar to increasing trends in total nitrogen.

The trends assessment was focused at locations where State and Federal agencies collect flow and nutrient samples as part of routine monitoring efforts. However, information about trends in nitrogen and phosphorus concentrations and loads also is needed at other locations where such information does not exist. Future efforts will focus on development of a Spatially Referenced Regression on Watershed Attributes (SPARROW) model to estimate total nitrogen and total phosphorus loadings at non-sampled locations in the study area. The SPARROW model is a non-linear regression model using constituent loads at known locations as dependent variables and spatially-derived source data (coupled with land-to-water and aquatic transport functions) as independent variables. Source data could include nitrogen from atmospheric deposition, fertilizer use, and manure applications. The SPARROW model is based on a digital stream network (for this effort, the U.S. Environmental Protection Agency Enhanced River Reach File 1 network will be used) and catchments derived from digital elevation data. Once calibrated, the SPARROW model can also be used to simulate potential changes in the study area such as population shifts, improvements in point sources, and improvements in agricultural best management practices.

Keywords: Models, Nutrients, Nonpoint Source Pollution, Water Quality



INVASIVES



Ecologically-based Invasive Aquatic Plant Management: Using Life History Analysis to Manage Aquatic Weeds

John D. Madsen
GeoResources Institute, Mississippi State University

Common Reed: *Phragmites Australis* (Cav.) Trin. Ex. Steud: Life History in the Mobile River Delta, Alabama

Joshua Cheshier and John D. Madsen
GeoResources Institute, Mississippi State University

Littoral Zone Plant Communities in the Ross Barnett Reservoir, MS

Ryan M. Wersal, John D. Madsen and Mary Love Tagert
GeoResources Institute, Mississippi State University

The Invasive Status of Giant Salvinia and Hydrilla in Mississippi

Wilfredo Robles, John D. Madsen, Victor L. Maddox and Ryan M. Wersal
GeoResources Institute, Mississippi State University

Ecologically-based Invasive Aquatic Plant Management: Using Life History Analysis to Manage Aquatic Weeds

John D. Madsen
GeoResources Institute
Mississippi State University
Box 9652
Mississippi State, MS 39762-9652
662-325-2428
E-mail: jmadsen@gri.msstate.edu

ABSTRACT

Invasive plants are increasingly recognized as a major problem in conserving and managing natural resources. Invasive aquatic plants not only threaten the diversity and functioning of aquatic, wetland, and riparian areas, but also contribute to flooding and reduce irrigation water flow. Management of these species has often focused on an engineering approach, either with direct herbicide application or mechanical removal, with little thought to the biology and ecology of the target species. I will demonstrate how knowledge of the life history of the target plant can greatly enhance management effectiveness using five examples: waterchestnut (*Trapa natans* L.), curlyleaf pondweed (*Potamogeton crispus* L.), Eurasian watermilfoil (*Myriophyllum spicatum* L.), hydrilla (*Hydrilla verticillata* (L.f.) Michx.), and waterhyacinth (*Eichhornia crassipes* (Mart.) Solms). For these analyses, I utilize studies that have focused on seasonal biomass allocation, carbohydrate storage, and propagule production. Waterchestnut is an annual, reproducing from seed. Successful long-term management must focus on preventing seed production. Curlyleaf pondweed is an herbaceous perennial, which overwinters using a turion. In this instance, management timing was critical in preventing turion formation and depleting the turion bank. Eurasian watermilfoil is a widespread evergreen perennial; management techniques can utilize the lack of resistant dormant propagules, as well as examining the timing of carbohydrate storage low points in selecting the best timing and management technique. Hydrilla uses several diverse life history strategies and is found as at least two distinct biotypes in the United States with very different phenologies. Understanding the differential response of the biotypes to the environment is one component to a successful management strategy. Waterhyacinth, a tropical plant, has shifted its life history pattern in subtropical and temperature zones. For all invasive plants of natural habitats, an understanding of the plant life history is vital to successful management.

Keywords: Ecology, Invasive species, Wetlands

Introduction

Aquatic plants, whether submersed, floating, or emergent, are an important component to aquatic ecosystems (Carpenter and Lodge 1986). Aquatic plants stabilize lake sediments, reducing sediment and nutrient resuspension. Aquatic plants increase sedimentation rates, reducing turbidity and suspended solids. Aquatic plants provide habitat for macroinvertebrates and forage fish, are critical to the spawning of some fish species, and generally provide a nursery

area for young-of-the-year fishes. Typically, nuisance problems develop in large water bodies through the introduction of invasive aquatic plants. Invasive aquatic plants are usually nonnative species that are well adapted to rapid growth, extensive spread, and competition with existing native vegetation (Madsen 2004). Invasive aquatic plants cause extensive disruption to economic uses of waterways, costing up to \$100M per year in damages and control costs (Pimentel et al. 2000). Impacts to human uses of water resources include

disruption of commercial navigation, hydropower generation, flood control, an recreational use; spread of insect-borne disease, reduction in property value, and direct impacts on human health (Madsen 1997). Ecological degradation caused by invasive plants includes degradation of water quality, reduction in species diversity, suppression of desirable native plant growth, localized extinction of rare, threatened, or endangered species, and alteration of predator/prey interactions (Mullin et al. 2000, Madsen 1997a).

Management of these species is typically approached from either an engineering (e.g., mechanical control) or biochemical perspective (e.g., chemical control), with limited consideration for the biology and ecology of the target plant species. The purpose of this paper is to demonstrate how the knowledge of the life history and ecology of the target plant can be utilized to identify weak points in the plant life cycle, and exploit them for long-term control (Madsen 1993a).

Plant Life History

Most aquatic plants initiate their growth in the early spring from low overwintering biomass, and increase their biomass exponentially until self-shading or self-limitation is reached. As the plant approaches its maximum point of biomass, typically the plant will flower, set fruit, and form its vegetative propagule. At this point, the plant will begin to senesce, and slough off excess biomass until the plant reaches its overwintering biomass point. For some plants, the overwintering or dormant mass is composed of green shoots, while other species have dormant stages composed of seeds or vegetative propagules (Westlake 1965, Wetzel 2001).

During the year, plants may utilize one or more strategies: sexual reproduction, vegetative reproduction, and clonal growth (Figure 1). Through sexual reproduction, plants form seeds (Figure 1A). Specific environmental cues regulate both the initiation of flowering, and the germination of seeds. Seeds are the most hardy and resistant propagule, but are often smaller than vegetative propagules (Madsen 1991). The second strategy, vegetative reproduction, involves the production of vegetative propagules such as tubers, turions, winter buds, and autofragments (Madsen 1991). Unlike

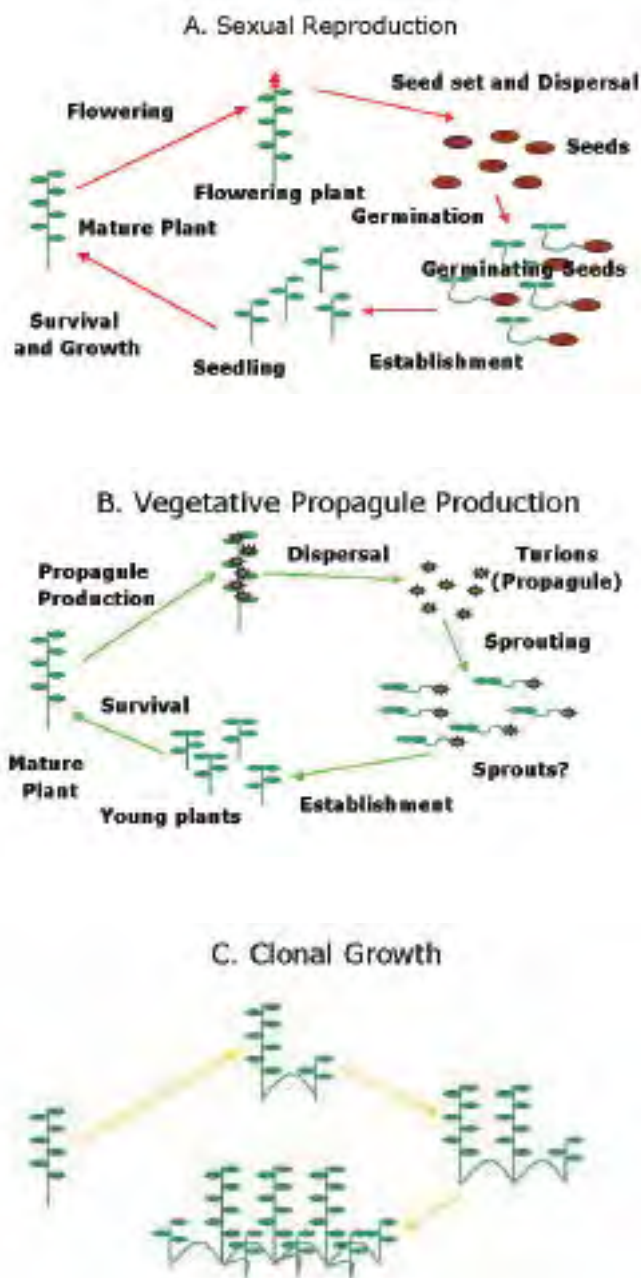

Figure 1. Life history strategies of plants during the year; A. sexual (seed-producing) strategy, B. vegetative propagule strategy, C. clonal growth strategy. An individual species may have any or all of these.

seed production, vegetative propagules are formed from the parent plant. As with seeds, specific environmental cues regulate both propagule production and propagule sprouting (Figure 1B). The third strategy is clonal growth, in which

more individual plants, or ramets, are formed by stolons, rhizomes, or runners (Figure 1C).

Aquatic plants are predominantly herbaceous, or non-woody, plants; and have three potential life history types: annual, herbaceous perennial, or evergreen perennial. The life history types are based on the propagule type that predominates for the dormant period, when the plant is not actively growing. The annual life history is one in which the entire green portion of the plant dies back during the dormant season, and the only portion of the plant present is the seed. Therefore, sexual reproduction is critical to the annual regeneration of this plant. The herbaceous perennial life history is one in which the only life stage present during the dormant period is the vegetative propagule, and the entire green portion of the plant dies. Therefore, the vegetative reproduction cycle is critical to the annual regeneration of this plant. The last common life history of aquatic plants is the evergreen perennial life history, in which there are green shoots present throughout the calendar year. While these plants may have propagules or seeds, green shoots that are not actively growing dominate the dormant period.

Application to Management

To demonstrate how this is applied to management, I will use four examples: waterchestnut (an annual), curlyleaf pondweed (an herbaceous perennial), hydrilla (either an herbaceous perennial or evergreen perennial), and Eurasian watermilfoil (an evergreen perennial). For each, research will be presented to demonstrate how the timing of management, and not the selection of management technique, is critical to improving long-term control of the species.

Waterchestnut.

Waterchestnut (*Trapa natans* L.) is a floating rosette-forming plant that typically grows in water from 1 to 4 meters in depth. A true annual, a single floating rosette can form up to a two dozen nutlets that are up to 4 grams fresh weight (Madsen 1990, Madsen 1993b, Methe et al. 1993). A native of eastern Asia, it is currently found in the northeastern United States (Madsen 1994, 1997a). In New York, the annual growth cycle initiates by seed germination in late March

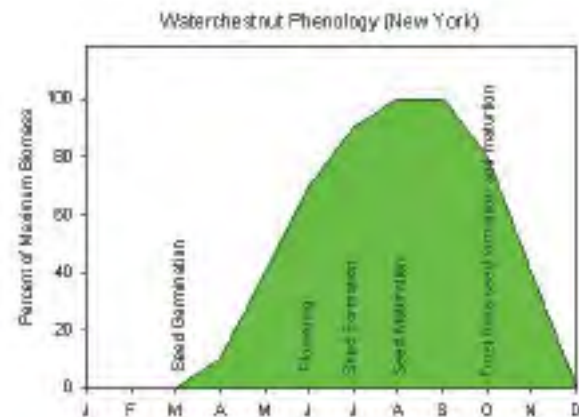

Figure 2. Annual growth cycle of the annual waterchestnut in New York State (from Madsen 1990).

to early May (Figure 2). By June, flowering begins, with seed formation and seed maturation following at four-week intervals afterwards. Seed production continues until the first heavy frost, typically in October. The key to long-term control of waterchestnut is to prevent new seed formation (Madsen 1993b).

The operators of Watervliet Reservoir, a drinking water supply overrun by waterchestnut, evaluated the effectiveness of long-term control by shallow-depth cutting. The City of Watervliet mounted a cutting bar on the front of an airboat that would cut rosettes only four inches below the surface of the water. Because of the rapid rate of cutting, they could cut waterchestnuts throughout the problem area as often as very two weeks, thus preventing the formation of mature seeds. Madsen (1993b) and Methe and others (1993) reported on seed production rates in untreated areas versus cut areas in 1989 and 1990, respectively. Seed production in untreated areas ranged from 140 to 210 new seeds per square meter per year, while areas that were cut lost 14 to 60 seeds per square meter per year from the seed bank. Therefore, cutting has potential for long-term control of waterchestnut.

Curlyleaf Pondweed.

Curlyleaf pondweed (*Potamogeton crispus* L.) is also a native of eastern Asia. It is a submersed plant that survives its dormant period in axillary turions, which are hardened axillary buds. Instead of overwintering, though, this plant

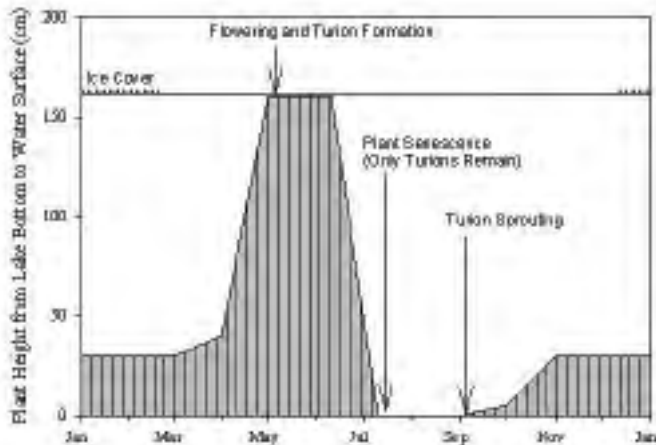

Figure 3. Life history of curlyleaf pondweed in Minnesota (from Woolf and Madsen 2003b).

oversummers (Woolf and Madsen 2003b, Figure 3). The plant survives its dormant period from July through September as the turion, which sprouts in September. Plant growth is slow over winter, but occurs rapidly beginning in March as water temperatures warm above 5 °C. Maximum biomass occurs in May, with flowering and turion formation beginning in June. By early July, the entire shoot biomass has died away. The key to long-term control of curlyleaf pondweed is to prevent turion formation (Woolf and Madsen 2003a).

Traditionally, herbicide treatments with contact herbicides in May or June provided short-term control of nuisance growth, but were not successful in long-term control of this species because turions had formed prior to herbicide applications. Herbicide applications would have to occur in March or April, in waters colder than indicated on the herbicide label. For long-term control, Netherland and others (2000) first had to demonstrate that the contact herbicides diquat and endothall could be effective at cold temperatures (10 to 15 °C). Once the effectiveness of endothall was established at low temperatures, a pond study verified that early season treatments in cold water before turion formation was initiated would significantly reduce turion and seedhead formation (Netherland et al. 2000, Skogerboe and Getsinger 2006). The key to long-term curlyleaf pondweed control was to control the shoots before turion formation had begun.

Hydrilla.

Hydrilla (*Hydrilla verticillata* (L.f.) Royle) is a submersed aquatic plant that can form dense masses of plants in water depths of up to 5 meters. A widespread nuisance plant in the east, southeast and California, it is currently the fastest-spreading invasive aquatic plant. Two biotypes are found in the United States: a dioecious strain in the southeast, and a monoecious biotype in the mid-Atlantic, northeast, California, and Washington. Hydrilla can grow as an evergreen perennial or an herbaceous perennial, depending on seasonal temperatures and biotype. Both biotypes form large numbers of axillary turions, subterranean turions (hereafter called tubers), and can also spread by stem fragments. The tubers are formed deep in the sediment, and resist management activities. The key to long-term control of hydrilla is to control or reduce the production of tubers.

In north Florida, dioecious hydrilla forms tubers from October through May, and the tubers sprout from April through November (Haller et al. 1976). One technique to successfully control hydrilla in lakes that have water level control structures was to dewater the lake (drawdown) from September through November, to kill the hydrilla before tubers could

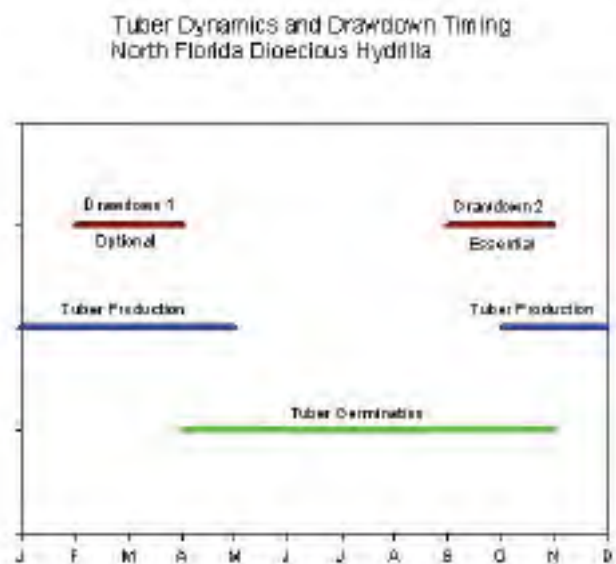

Figure 4. Timing of hydrilla tuber germination and production in North Florida, and optimal times for drawdown to control tubers. Redrawn from Haller et al. 1976.

Madsen

be formed, with an additional drawdown in early spring (February to April) to stimulate additional tuber sprouting (Figure 4, Haller et al. 1976). Long-term hydrilla control is management of the tuber bank.

Eurasian watermilfoil.

Eurasian watermilfoil (*Myriophyllum spicatum* L.) is an evergreen perennial submersed aquatic plant, growing rooted to the bottom and forming a canopy in water from 1 to 5 m deep, although it can grow deeper in exceptionally clear water. Eurasian watermilfoil is possibly the most widespread invasive aquatic plant in the United States, with infestations from Maine to Florida to California to Washington and all states in between (Madsen 2005). The annual growth cycle varies tremendously across this range, from a winter dormant and late summer peak growth in cold northern lakes to a summer dormant plant with peaks in spring and fall (Figure 5).

Eurasian watermilfoil does not possess any specialized vegetative propagule, and seeds are not considered important to its propagation and spread; but this plant does

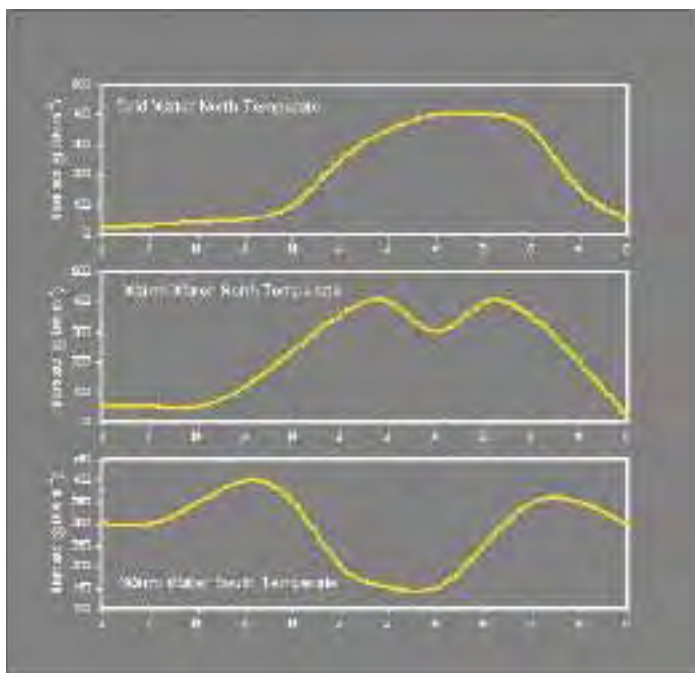

Figure 5. Growth cycles of Eurasian watermilfoil from cold northern lakes, to shallow mid-continental lakes, and southern ponds (from Madsen 2005).

form a unique propagule: stem fragments can be formed by abscission (Madsen et al. 1988, Smith et al. 2002). While a number of factors are important to the density of fragments formed, autofragmentation does tend to occur seasonally just after flowering. This time period also coincides with the lowest point in carbohydrate storage in the plant (Madsen 1997b). Evergreen perennial plants rely on stored carbohydrates to regrow from dormant periods or plant damage. Timing management to occur just before flowering can gain the two-fold benefit of preventing the spread of Eurasian watermilfoil through autofragmentation and of exploiting a low-point in carbohydrate storage to reduce potential regrowth. Owens and Madsen (1998) demonstrated that control of Eurasian watermilfoil could be improved by timing the application of a contact herbicide (endothall) to the low-point in carbohydrate storage.

Summary

Three important points should be gained from these examples. First, the life history and seasonal growth patterns are critical to long-term control of invasive aquatic plant species, and thus it is vital to know the growth pattern of the target invasive plant in your region. Second, the management technique itself is not of primary importance, so long as the technique can be utilized to further long-term control of the plant. Many different techniques (biological, chemical, mechanical, and physical) can be utilized to achieve long-term control, depending on the plant species, the location, and the constraints of the site. I have presented examples of long-term management that utilized completely different techniques, mechanical (cutting), chemical (endothall herbicide) and physical (drawdown). Third, research on the ecology and life history of target invasive aquatic plants linked with research on control techniques themselves will provide substantial benefits in terms of improved long-term control of invasive plants.

Acknowledgements

Approved for publication by the Mississippi Agricultural and Forestry Experiment Station Publication. Kurt Getsinger, Al Rankins, and David Spencer provided reviews of this

manuscript.

Literature Cited

- Carpenter, S.R. and D.M. Lodge. 1986. Effects of submersed macrophytes on ecosystem processes. *Aquat. Bot.* 26:341-370.
- Haller, W.T., J.L. Miller, and L.A. Garrard. 1976. Seasonal production and germination of hydrilla vegetative propagules. *J. Aquat. Plant Manage.* 14:26-29.
- Madsen, J.D. 1990. Waterchestnut (*Trapa natans* L.) Research in Watervliet Reservoir – 1989 Report. Fresh Water Institute Report #90-8, Rensselaer Fresh Water Institute, Rensselaer Polytechnic Institute, Troy, NY. April 1990. 29pp.
- Madsen, J.D. 1991. Resource allocation at the individual plant level. *Aquat. Bot.* 41:67-86.
- Madsen, J.D. 1993a. Control points in the phenological cycle of Eurasian watermilfoil. Information Exchange Bulletin A-93-1, U.S. Army Engineer Waterways Experiment Station, Vicksburg, MS. June 1993, 10pp.
- Madsen, J.D. 1993b. Waterchestnut seed production and management in Watervliet Reservoir, New York. *J. Aquat. Plant Manage.* 31:271-272.
- Madsen, J.D. 1994. Invasions and declines of submersed macrophytes in Lake George and other Adirondack lakes. *Lake Reserv. Manage.* 10:19-23.
- Madsen, J.D. 1997a. Chapter 12. Methods for Management of Nonindigenous Aquatic Plants, pp. 145-171. In: J.O. Luken and J.W. Thieret, eds. *Assessment and Management of Plant Invasions*. Springer, New York. 324pp.
- Madsen, J.D. 1997b. Seasonal biomass and carbohydrate allocation in a southern population of Eurasian watermilfoil. *J. Aquat. Plant Manage.* 35:15-21.
- Madsen, J.D. 2004. Invasive aquatic plants: A threat to Mississippi water resources. 2004 Proceedings, Mississippi Water Resources Conference, pp. 122-134.
- Madsen, J. D. 2005. Eurasian Watermilfoil Invasions and Management Across the United States. *Currents: The Journal of Marine Education.* 21 (2): 21-26.
- Madsen, J.D., L.W. Eichler, and C.W. Boylen. 1988. Vegetative spread of Eurasian watermilfoil in Lake George, New York. *J. Aquat. Plant Manage.* 26:47-50.
- Methe, B.A., R.J. Soracco, J.D. Madsen, and C.W. Boylen. 1993. Seed production and growth of waterchestnut as influenced by cutting. *J. Aquat. Plant Manage.* 31:154-157.
- Mullin, B.H., L. W.J. Anderson, J.M. DiTomaso, R.E. Eplee, and K.D. Getsinger. 2000. *Invasive Plant Species*. Issue Paper Number 13, Council for Agricultural Science and Technology, Washington, D.C. February 2000. 18pp.
- Netherland, M.D., J.D. Skogerboe, C.S. Owens, and J.D. Madsen. 2000. Influence of water temperature on the efficacy of diquat and endothall versus curlyleaf pondweed. *J. Aquat. Plant Manage.* 38:25-32.
- Owens, C.S. and J.D. Madsen. 1998. Eurasian watermilfoil control using a contact herbicide phenological timing. Aquatic Plant Control Technical Note CC-01, U.S. Army Engineer Waterways Experiment Station, Vicksburg, MS. 9pp.
- Pimentel, D., L. Lach, R. Zuniga, and D. Morrison. 2000. Environmental and economic costs of nonindigenous species in the United States. *BioScience* 50:53-65.
- Skogerboe, J. G. and Getsinger, K. D. 2006. Selective Control of Eurasian Watermilfoil and Curlyleaf Pondweed Using Low Doses of Endothall Combined with 2,4-D, ERDC/TN APCRP-CC-05, U.S. Army Engineer Research and Development Center, Vicksburg, MS.

Ecologically-based Invasive Aquatic Plant Management: Using Life History Analysis to Manage Aquatic Weeds

Madsen

Smith, D.H., J.D. Madsen, K.L. Dickson, and T.L. Beitinger. 2002. Nutrient effects on autofragmentation of *Myriophyllum spicatum*. *Aquat. Bot.* 74:1-17.

Westlake, D.F. 1965. Some basic data for the investigations of the productivity of aquatic macrophytes. *Mem. Ist. Ital. Idrobiol.* 18(Suppl.):229-248.

Wetzel, R.G. 2001. *Limnology: Lake and River Ecosystems*, 3rd Ed. Academic Press, San Diego. 1006pp.

Woolf, T.E. and J.D. Madsen. 2003a. Seasonal biomass and carbohydrate allocation patterns in southern Minnesota curlyleaf pondweed populations. *J. Aquat. Plant Manage.* 41:113-118.

Woolf, T.E. and J.D. Madsen. 2003b. Seasonal biomass and carbohydrate allocation patterns in southern Minnesota curlyleaf pondweed (*Potamogeton crispus*) populations. Letter Report, Minnesota State University, Mankato. May, 2003. 59pp.

Common Reed: *Phragmites Australis* (Cav.) Trin. Ex. Steud: Life History in the Mobile River Delta, Alabama

Joshua C. Cheshier and John D. Madsen
GeoResources Institute
Mississippi State University
Box 9952
Starkville, MS 39762
662-325-221
E-mail: Cheshier@gri.msstate.edu

ABSTRACT

Common reed (*Phragmites australis*) is a non-native invasive perennial grass that creates a nuisance in aquatic and riparian environments across the United States. The ability of common reed to reproduce quickly combined with its ability to cycle nutrients has made it an aggressive invader of riparian and wetland ecosystems. Common reed often forms monotypic stands that displace native vegetation more desirable as wildlife food and cover than common reed. Common reed has been differentiated into multiple haplotypes, two haplotypes being native to North America, and a non-native, European haplotype. The European haplotype is of concern due to its ability to out compete native vegetation, alter hydrology, and change community structure of aquatic and riparian habitats. In order to help maintain native habitats and manage and populations of common reed in the United States, a complete understanding of its life cycle is needed. Twelve samples were taken from four sites in Mobile River Delta, AL from January 2006 until December 2006. Above ground biomass allocation is highest from July through September with a high of 2.9 kg/m². Below ground biomass allocation was highest from May through August with a high of 2.7 kg/m² in May. This understanding will provide insights into the relationships between common reed and the environment as well as to guide management strategies.

Keywords: Ecology, Invasive species, Phragmites, Wetlands

Littoral Zone Plant Communities in the Ross Barnett Reservoir, MS

Ryan M. Wersal, John D. Madsen and Mary Love Tagert
GeoResources Institute
Mississippi State University
Box 9652
Mississippi State, MS 39762-9652
662-325-4595
E-mail rwersal@gri.msstate.edu

ABSTRACT

The Ross Barnett Reservoir is a 33,000 acre surface water impoundment created on the Pearl River near Jackson, Mississippi. The Reservoir is the primary source of potable water for the city of Jackson. It also provides recreational opportunities in the form of fishing, boating, water sports, and onshore camping and hiking; activities that bring revenue to the state. In recent years, non-native aquatic macrophytes have increased in distribution, impeding navigation, fishing, and reduced the aesthetics of waterfront properties. The Pearl River Valley Water Supply District requested assistance in developing and implementing a long term management plan for the Reservoir. Prior to developing and implementing lake-wide management programs, reservoir-wide surveys were needed to assess the current distribution of plant communities in the Reservoir. For this reason, we conducted a whole-lake survey in June 2005 to assess the distribution and abundance of plant communities in the Reservoir. In October 2006 a survey of the littoral zone (water depths of ≤ 10 feet) was conducted based on the points sampled in 2005. A plant rake was deployed at each of the 508 points visited. Species distribution was mapped using handheld computers outfitted with GPS receivers, and data stored in database templates using Farm Site Mate software. Areas of increased plant occurrence were in the upper Reservoir, Pelahatchie Bay, and along the eastern shoreline. A total of 21 aquatic or riparian plant species were observed growing in or along the shoreline of the littoral zone. American lotus and water primrose were the most common plant species observed in the littoral zone (17.7 % and 7.4% respectively). Non-native plants included alligatorweed (3.9%), waterhyacinth (2.9%), and hydrilla (0.6%). Bladderwort, a native submersed aquatic plant was also observed (0.4%) for the first time. Overall, species distribution was lower during October 2006 than in 2005.

Keywords: Invasive species, Ecology, Water Use, Wetlands

Introduction

The Ross Barnett Reservoir is a 13,400 hectare (33,000 acre) freshwater impoundment that is located just north of Jackson, Mississippi. The reservoir is the largest surface water impoundment in Mississippi and serves as the primary drinking water supply for the City of Jackson. The reservoir is surrounded by over 4,600 homes and provides recreation in the form of fishing, boating, camping, and trail systems along the shoreline. In recent years, invasive plant species have become an increasing problem by clogging navigation chan-

nels, reducing recreational fishing opportunities, and reducing access for users of the reservoir (Madsen 2004).

In 2005, hydrilla (*Hydrilla verticillata* L.f. Royle) was discovered at four locations within the Reservoir (Wersal et al. 2006). Hydrilla is an invasive submersed aquatic plant that was introduced into the United States in the 1960's by the aquaria market (Blackburn et al. 1969). Hydrilla is spread by asexual reproduction via tubers (produced below the sediment), turions (produced in leaf axils), and fragmentation of stems. These reproductive structures can remain viable for

several days out of water, remain in the sediment up to four years, survive the ingestion and regurgitation of waterfowl, and survive herbicide applications (Langeland 1996). Hydrilla has been called "the perfect aquatic weed" as a result of its reproductive mechanisms and its resiliency to survive under adverse environmental conditions (Langeland 1996).

The objectives of this study were to 1) monitor the aquatic plant community in the Ross Barnett Reservoir, specifically plants growing in the littoral zone; 2) identify new hydrilla populations and monitor populations that already exist; and 3) assess herbicide applications of established hydrilla populations.

Materials and Methods

Vegetation Survey

Aquatic plant distribution was evaluated using a point intercept survey method using a 300 meter grid in October 2006 (Madsen 1999). The grid of points for the current survey was modified from the 2005 survey to include only those points occurring in water depths of ≤ 3 meters (Wersal et al. 2006). Sampling points in this manner allowed for a more rigorous survey of the littoral zone, the portion of the reservoir most likely to be inhabited with aquatic plants (Figure 1). There were still areas within the littoral zone that were inaccessible by boat due to low water levels experienced at the time of the survey. Points that were located in those areas

Sample Locations During October 2006 Survey

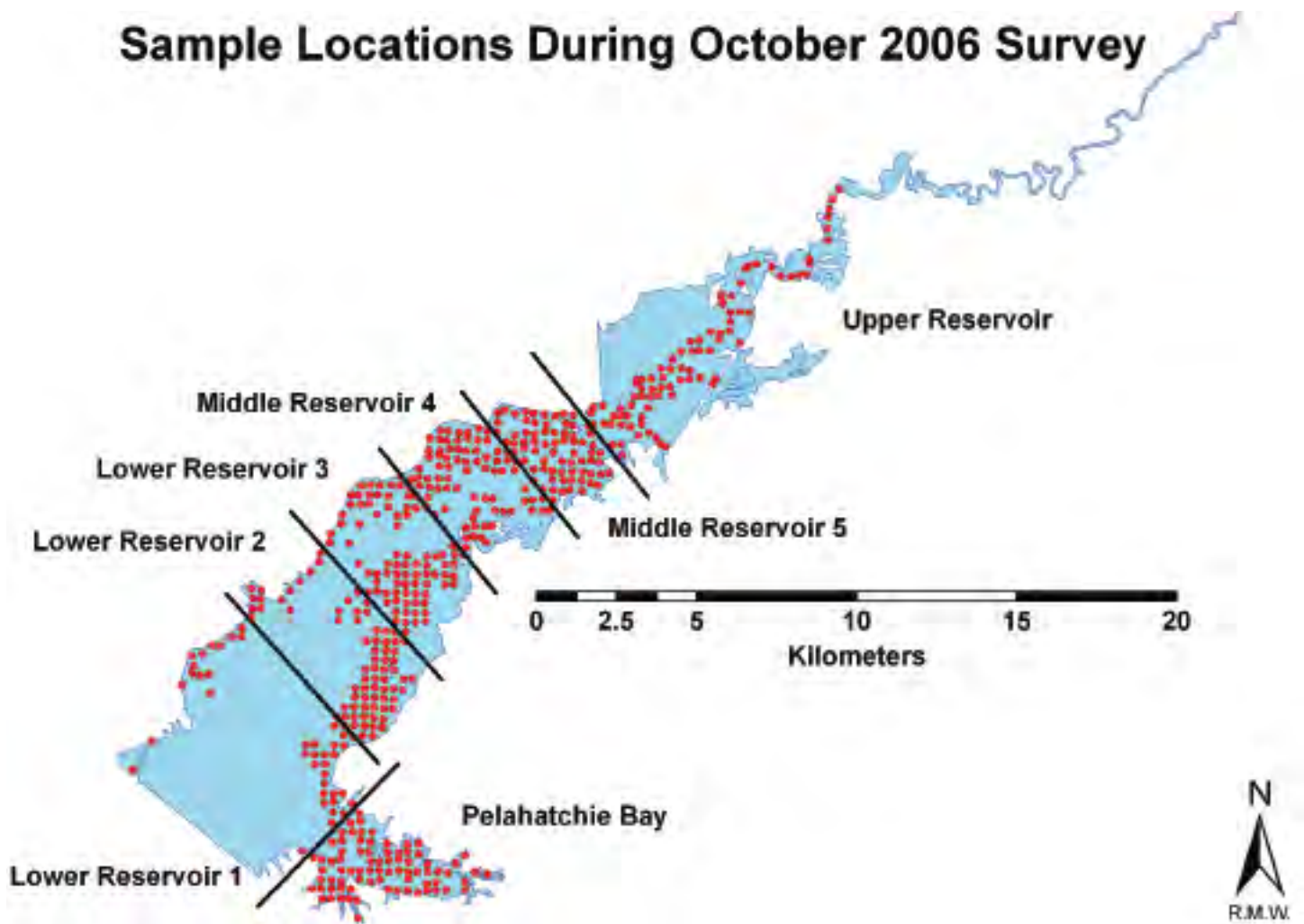

Figure 1. Points sampled within the littoral zone of the Ross Barnett Reservoir during the survey conducted in October 2006.

were not sampled. For the purposes of recording data, the reservoir was divided into seven sections: Upper Reservoir, Middle Reservoir 5, Middle Reservoir 4, Lower Reservoir 3, Lower Reservoir 2, Lower Reservoir 1, and Pelahatchie Bay.

A hand-held personal digital assistant (PDA) outfitted with a global positioning systems (GPS) receiver was used to navigate to each point. Spatial data were directly recorded in the hand-held computer using Farm Works® Farm Site Mate software. Data were recorded in database templates using specific pick lists constructed for this project. The software provides an environment for displaying geographic and attribute data and enables navigation to specific points during the survey. A total of 508 points were sampled by deploying a rake to determine the presence or absence of aquatic plant species. Percent frequency of occurrence was calculated for each species by dividing the number of detections for that species by the total number of points sampled. Estimated total acreage for commonly occurring aquatic plant species was also calculated by using the total number of points that a given species was observed at and multiplying that number by 39.5 (the acreage represented by one survey point).

Hydrilla Population Assessment

Thirty and 60 days after fluridone treatments to the four hydrilla populations (Site 1, Site 2, Site 3, and Site 4) in April 2006, approximately 25 plant rake tosses were performed in each of the hydrilla sites to assess herbicide efficacy on hydrilla. Also, a tuber survey of the four hydrilla sites was conducted in February and December of 2006 to assess the density of the tuber bank. Thirty core samples were collected within each hydrilla site using a PVC (0.018 m²) coring device (Madsen et al. 2007). Core samples were washed in a pail with a 0.25 m² wire mesh bottom to separate plant material (tubers) from the sediment. Plant material was placed into 3.78 Liter Ziploc® bags for transport back to Mississippi State University. Samples were sorted, dried to a constant mass, and weighed to assess tuber biomass and density.

Results

Vegetation Survey

A total of 19 species of aquatic or riparian plants were observed during the survey. Of the 19 species, 15 are strictly aquatic species (Table 1). Alligatorweed was the exotic invasive aquatic plant species observed most often, followed by waterhyacinth and hydrilla. The distributions of these species were located primarily in the Upper Reservoir and Pelahatchie Bay. Native species found during the survey include American lotus, coontail, fragrant waterlily, American pondweed, duckweed, frogbit, cattail, soft-stem bulrush, two species of arrowhead, and bladderwort (Table 1). American lotus was the most common native plant species observed, followed by waterprimrose. American lotus was observed throughout the Reservoir, with increased occurrence in the Upper Reservoir and Pelahatchie Bay. The occurrence of aquatic plants was greatest in the Upper Reservoir and Pelahatchie Bay. Species occurrence was low in parts of the Middle Reservoir and the Lower Reservoir where water depths are too great to support aquatic plant growth.

The estimated acreages for the commonly occurring native and non-native aquatic plant species are shown in Table 2. Native species occupied the greatest area, with American lotus occupying the largest area (1998 acres), followed by waterprimrose (844 acres), and coontail (555 acres). The non-native alligatorweed occupied approximately 444 acres followed by waterhyacinth (333 acres), and hydrilla (67 acres). Based on these acreage estimates, native plant species occupy the greatest area and non-native aquatic plant species currently occupy less than 2.5% of the total Reservoir area. These estimates are derived from the point survey, in which each point of occurrence represents 22.2 acres. There were approximately 125 acres of hydrilla treated in 2006 resulting in a 54% reduction based on the estimates from the survey. For accurate mapping of waterhyacinth and alligatorweed, the use of remote sensing may be needed, since access is limited in some areas where these species are found.

Table 1. Percent frequency of occurrence for plant species observed in the littoral zone during the survey, October 2006 (n=508). The percent frequency of occurrence reported for 2005 data (n=677) are from points that were sampled in 3 m of water or less during that survey.

Species Name	Common Name	Native (N) or Exotic (E), Invasive (I)	2005 ¹ % Frequency	2006 % Frequency
<i>Alternanthera philoxeroides</i>	alligatorweed	E I	21.10	3.94
<i>Azolla caroliniana</i>	mosquito fern	N	0.00	0.20
<i>Cabomba caroliniana</i>	fanwort	N	2.20	0.00
<i>Ceratophyllum demersum</i>	coontail	N	4.40	4.92
<i>Colocasia esculenta</i>	wild taro	E I	0.00	0.98
<i>Eichhornia crassipes</i>	waterhyacinth	E I	4.90	2.95
<i>Hydrilla verticillata</i>	hydrilla	E I	0.00	0.79
<i>Hydrocotyle ranunculoides</i>	pennywort	N	6.40	0.59
<i>Lemna minor</i>	common duckweed	N	3.10	2.56
<i>Limnobium spongia</i>	American frogbit	N	1.50	0.79
<i>Ludwigia peploides</i>	waterprimrose	N	4.90	7.48
<i>Myriophyllum aquaticum</i>	parrotfeather	E I	0.70	0.00
<i>Nelumbo lutea</i>	American lotus	N	17.10	17.72
<i>Nitella</i> sp.	stonewort	N	0.10	0.00
<i>Nuphar odorata</i>	fragrant waterlily	N	4.40	3.35
<i>Potamogeton nodosus</i>	American pondweed	N	2.70	2.76
<i>Sagittaria latifolia</i>	arrowhead	N	1.00	1.18
<i>Sagittaria platyphylla</i>	arrowhead	n	0.00	1.77
<i>Scirpus validus</i>	softstem bulrush	N	1.20	0.20
<i>Typha</i> sp.	cattail	N	1.30	2.36
<i>Utricularia vulgaris</i>	bladderwort	N	0.00	0.39
<i>Zizaniopsis miliacea</i>	giant cutgrass	N I	1.50	3.54

¹A direct comparison between years is not valid due to the different times of the year that the two surveys were conducted. The difference in time likely introduced seasonal effects on the growth of aquatic plant species.

Hydrilla Population Assessment

Hydrilla was observed growing at the four locations treated with fluridone during the water sample collection at 30 and 60 days after treatment. Although plants were found, they exhibited symptoms typical of exposure to fluridone. During the October survey, hydrilla was observed

growing in a previously unreported area near a boat landing along Pipeline Road on the eastern side of the Upper Reservoir (Figure 2). The hydrilla observed at these sites was green, healthy, and exhibited no herbicide symptoms. There was no hydrilla observed at Site 3 on the western side of the Reservoir. Hydrilla Site 4 was not sampled due to low water

Table 2. Estimated acreage of the commonly occurring aquatic plants in the littoral zone during the Ross Barnett Reservoir Survey, October 2006.

Species Name	Common Name	Native (N) or Exotic (E), Invasive (I)	Estimated Acreage ¹
<i>Alternanthera philoxeroides</i>	alligatorweed	E I	444
<i>Eichhornia crassipes</i>	waterhyacinth	E I	333
<i>Hydrilla verticillata</i>	hydrilla	E I	67
<i>Ceratophyllum demersum</i>	coontail	N	555
<i>Lemna minor</i>	common duckweed	N	289
<i>Ludwigia peploides</i>	waterprimrose	N	844
<i>Nelumbo lutea</i>	American lotus	N	1998
<i>Nuphar odorata</i>	fragrant waterlily	N	377
<i>Potamogeton nodosus</i>	American pondweed	N	310

¹Each point of the survey represents approximately 22.2 acres.

Hydrilla Locations During October 2006

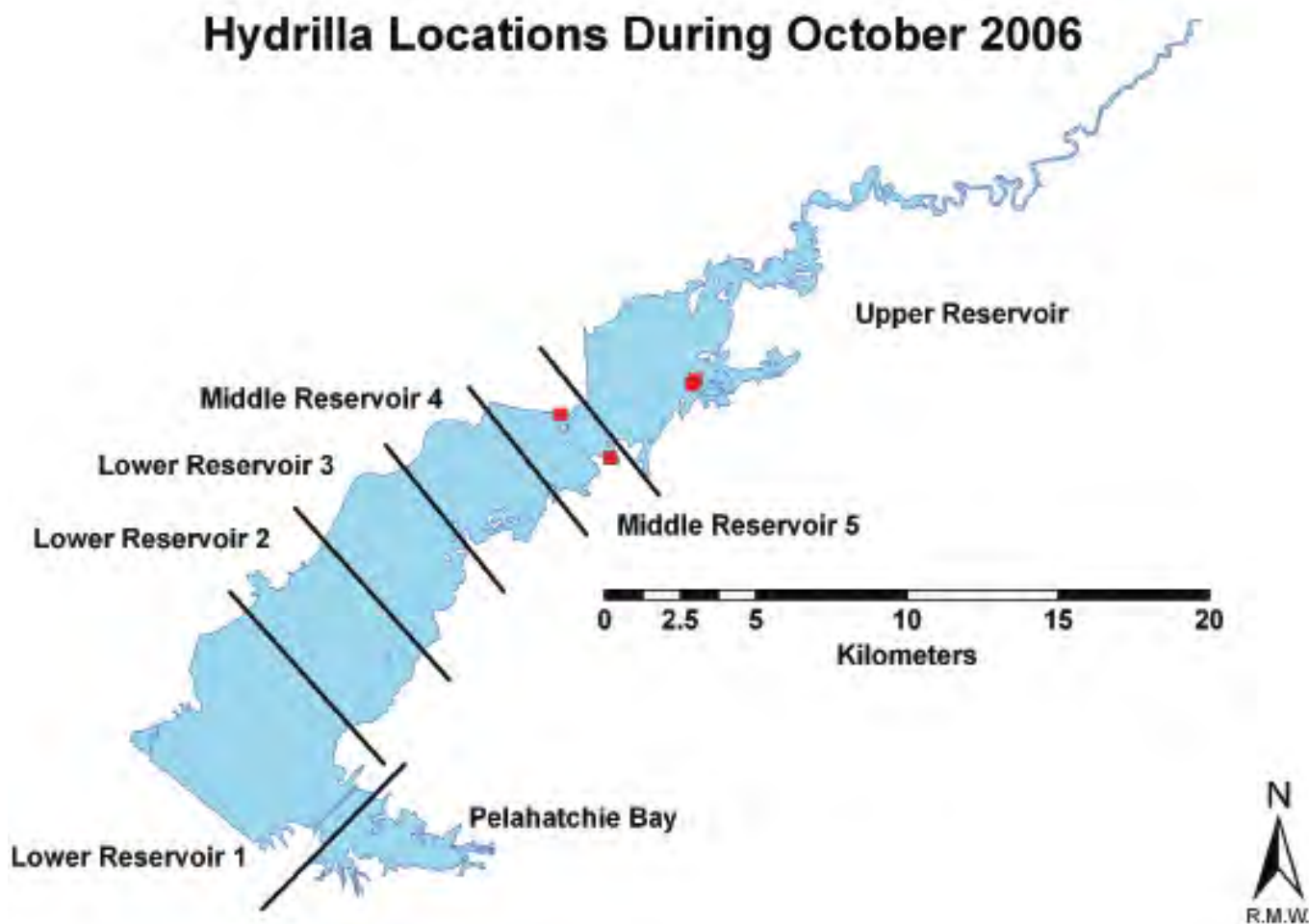

Figure 2. Locations of hydrilla in the Ross Barnett Reservoir, October 2006.

depths and the inaccessibility by boat to these points. Based on the October survey and the finding of a new hydrilla population, the Ross Barnett Reservoir now has at least five separate locations where hydrilla is growing.

Hydrilla is typically a prolific producer of tubers, however, no tubers were found at any of the hydrilla sites surveyed in February 2006. During a similar survey of the same four sites in December 2006, only two tubers were found. These tubers were found in Site 4 and appeared unviable. A single small shoot of hydrilla was also found in Site 1 and appeared to be healthy and viable.

Discussion

Aquatic plant growth in the Ross Barnett Reservoir appears to be limited to the Upper Reservoir, Pelahatchie Bay, and the eastern shoreline of the Reservoir. Species that are able to overcome deficiencies in light availability were observed most often. These species included American lotus, alligatorweed, waterprimrose, and waterhyacinth, species with an emergent or floating growth habit. Light profiles from seven sites within the Reservoir indicate that light transmittance is less than 20% in the upper 3 ft of the water column (Wersal et al. 2006). The limitation of light in deeper water areas excludes submersed plant species from inhabiting these areas and forces colonization to shallower water depths where greater than 21% of surface light reaches the bottom sediments (Chambers and Kalff 1985). However, species such as coontail and hydrilla are well adapted to survive in low light environments and have mechanisms to overcome the stresses associated with light limitations, which may explain their dominance as submersed species in the Reservoir. Under low light availability, hydrilla can increase its shoot length to reach the water surface rapidly where it forms a dense canopy to overcome deficiencies in light availability (Barko and Smart 1981). The elongation of shoots under low light conditions may allow hydrilla to expand its depth distribution more so than other species (Barko and Smart 1981). Furthermore, the ability of hydrilla to increase shoot elongation confers a competitive advantage over other species in waterbodies of limited transparency (Barko and Smart 1981).

Intensive management efforts have been deployed to control the hydrilla populations in the Reservoir. These include herbicide applications of endothall in the fall of 2005 to control actively growing hydrilla prior to tuber formation, followed by spring to early summer herbicide applications of fluridone in 2006 to offer greater control of new hydrilla growth. Intensive monitoring was conducted in and around the hydrilla populations following the fluridone applications. To date, only two tubers have been collected, indicating that the tuber bank may be small and year-to-year recruitment is from over-wintering of individual plants or from fragmentation of live stems. The potential small size of the tuber bank may be a good indicator of how long hydrilla has been growing in the reservoir and also an indicator of the potential for eradication. The longevity of hydrilla tubers is unknown, but field evidence suggests that there has been a decrease in tuber numbers over time following fluridone treatments (Netherlands 1997). However, it has also been noted that hydrilla tubers can remain viable for up to three years following an application (Netherlands 1997). The tubers found during the December survey were soft, white, and appeared non-viable, likely a result of the fluridone treatments. Long-term monitoring and repeated herbicide applications to hydrilla populations need to continue to allow for effective control of hydrilla from the Reservoir.

Acknowledgements

Approved for publication by the Mississippi Agricultural and Forestry Experiment Station. The Pearl River Valley Water Supply District funded this research. We thank Billy Lester, Wilfredo Robles, Josh Cheshier, and Jimmy Peebles for assisting during the survey. Joe Massey, Victor Maddox, and Todd Tietjen provided reviews of this manuscript.

Literature Cited

Barko, J. W. and R. M. Smart. 1981. Comparative influences of light and temperature on the growth and metabolism of selected submersed freshwater macrophytes. *Ecological Monographs* 51:219-235.

Blackburn, R. D., L. W. Weldon, R. R. Yeo, and T. M. Taylor. 1969. Identification and distribution of certain similar-appearing submersed aquatic weeds in Florida. *Hyacinth Control Journal* 8:17-23.

Chambers, P. A., and J. Kalf. 1985. Depth distribution and biomass of submersed aquatic macrophyte communities in relation to Secchi depth. *Canadian Journal of Fisheries and Aquatic Sciences* 42:701-709.

Langeland, K. A. 1996. *Hydrilla verticillata* (L. F.) Royle (Hydrocharitaceae), "The perfect aquatic weed". *Castanea* 61: 293-304.

Madsen, J. D. 1999. Point and line intercept methods for aquatic plant management. APCRP Technical Notes Collection (TN APCRP-M1-02), U.S. Army Engineer Research and Development Center, Vicksburg, MS, USA.

Madsen, J. D. 2004. Invasive aquatic plants: A threat to Mississippi water resources. 2004 Proceedings, Mississippi Water Resources Conference, pp. 122-134, Mississippi State University and Water Resources Institute, Mississippi State, MS.

Madsen, J. D., R. M. Wersal, and T. E. Woolf. 2007. A new core sampler for estimating biomass of submersed aquatic macrophytes. *Journal of Aquatic Plant Management* 45:31-34.

Netherland, M. D. 1997. Turion ecology of hydrilla. *Journal of Aquatic Plant Management* 35:1-10.

Wersal, R. M., J. D. Madsen, and M. L. Tagert. 2006. Aquatic plant survey of Ross Barnett Reservoir for 2005. GeoResources Institute Report 5003 11pp.

The Invasive Status of Giant Salvinia and Hydrilla in Mississippi

Wilfredo Robles, John D. Madsen, Victor L. Maddox and Ryan M. Wersal
GeoResources Institute
Mississippi State University
Box 9952
Starkville, MS 39762
662-325-2311
E-mail: wr40@pss.msstate.edu

ABSTRACT

Giant salvinia (*Salvinia molesta* Mitchell) is a nuisance, free-floating aquatic fern that can double biomass in 10 days through vegetative reproduction. Hydrilla (*Hydrilla verticillata* (L.f.) Royle) is a perennial submersed aquatic plant that can propagate from stem fragments, turions, and subterranean tubers representing a triple threat for management methods. Both plants disrupt water bodies by affecting ecological interactions and halting boat traffic. Surveys were conducted during 2005-06 to detect the current status of giant salvinia and hydrilla in Mississippi. Giant salvinia was found at the Wedgeworth Creek located northeast of Leaf River near Petal in Forrest County. To date, giant salvinia has not escaped into the Leaf River. The bio-control agent *Cyrtobagous salviniae* has been released at this site; however, no suppression and damage was noticed on the giant salvinia population. Hydrilla has been found in Lake Aberdeen, Aliceville Lake, Columbus Lake, Ross Barnett Reservoir, and Loakfoma Lake on the Noxubee National Wildlife Refuge (NWR). Management practices have been addressed for hydrilla control in the Ross Barnett Reservoir and Noxubee NWR. However, Lake Aberdeen, Aliceville Lake, and Columbus Lake are not currently under active management. Further surveys should be conducted to track giant salvinia and hydrilla spread over the reported sites as well as examine their presence in other of Mississippi water bodies.

Keywords: Invasive species, Ecology, Wetlands

Introduction

Invasive aquatic plant species are a significant threat to the water resources and wetlands of the nation, including the state of Mississippi. For instance, invasive aquatic plants disrupt many bodies of water, affecting the ecological interactions, disrupting water supply, and impeding boat traffic. Two species in particular, hydrilla (*Hydrilla verticillata* (L.f.) Royle) and giant salvinia (*Salvinia molesta* Mitchell) are considered invasive aquatic plants worldwide. Giant salvinia is a free-floating aquatic fern that can double its biomass in ten days through vegetative reproduction. Hydrilla is a submersed aquatic plant that can propagate from stem fragments, turions, and subterranean tubers, representing a triple threat for management methods. Both plants are listed as

noxious weeds on both the Federal Noxious Weed List and the Noxious Weed List for the state of Mississippi.

Both also are present in Mississippi (Madsen et al., 2006). However, little information exists on the number of water bodies impacted and threat, county records, and control methods to date for these two species.

Methods

An extensive survey was conducted in 2006 throughout Mississippi to detect the presence of giant salvinia and hydrilla. A total of 17 counties were surveyed including reservoirs, waterways and major rivers (Table 1). A handheld computer with Global Positioning System (GPS) capabilities was used to obtain geographic coordinates of surveyed locations.

Table 1. MS counties and water bodies surveyed in 2006 as depicted in Figure 1. (Positive location = +; Negative location = -)

County Name	Water Body	Hydrilla	Giant Salvinia
Attala	Yockanookany River	-	-
Clay	Lake Columbus	+	-
Forrest	Wedgeworth Creek	-	+
	Leaf River	-	-
George	Pascagoula River	-	-
Greene	Leaf River	-	-
	Chickasawhay River	-	-
Jackson	Pascagoula River	-	-
Leake	Yockanookany River	-	-
Leflore	Yazoo River	-	-
Lowndes	Lake Columbus	+	-
Madison	Ross Barnett Reservoir	+	-
Monroe	Lake Aberdeen	+	-
Noxubee	Noxubee National Wildlife Refuge	+	-
	Lake Aliceville	+	-
Oktibbeha	Private Pond	-	-
Perry	Leaf River	-	-
Rankin	Ross Barnett Reservoir	+	-
Washington	Oxbow east of Mississippi River	-	-
Webster	Big Black River	-	-

Data were acquired and reported in latitude and longitude, datum World Geodetic System (WGS 84). Once the GPS points were recorded, 2005 aerial photography at 2-meter resolution was used to make distribution maps and establish potential sites for the spread of hydrilla and giant salvinia (maps not shown). Maps were built in ArcGIS-ArcMap, v. 9.1 software (ESRI 2005). Aerial photography by county was downloaded from the Mississippi Automated Resource Information System (MARIS) (<http://www.maris.state.ms.us>) web page. In order to have information about control methods performed on these two plants in the surveyed water body, agencies managing the water body were contacted.

Any control method performed in the water body was rated as achieving poor, fair, good, and excellent control at the time of the survey.

For hydrilla, we selected and extended potential survey sites by contacting natural resource agencies in the state, as well as encountering hydrilla infestations as part of our other research activities. For giant salvinia, surveys at known sites were performed including southern Mississippi counties after Hurricane Katrina. Current sites were widely surveyed to detect giant salvinia presence and its potential spread to connected water bodies.

Results and Discussion

Presence and absence of hydrilla and giant salvinia in Mississippi in the 2006 survey are presented in Table 1 and Figure 1. The status of each plant and description of known locations will be discussed as well as the performance of control methods used at each water body.

Hydrilla Status

Tennessee-Tombigbee Waterway

Hydrilla was found in the Tennessee Tombigbee Waterway at Lake Aberdeen, Lake Columbus, and Lake Aliceville (Table 1). Associated species growing with hydrilla include: waterhyacinth (*Eichhornia crassipes* (Mart.) Solms), coontail (*Ceratophyllum demersum* L.), and Eurasian watermilfoil (*Myriophyllum spicatum* L.). At Lake Aberdeen and Lake Aliceville, hydrilla has been found localized at boat ramps and scattered along shorelines at depths of 2 feet. However, hydrilla populations have expanded in Lake Columbus since 2005, after control activities reduced waterhyacinth abundance. The Lake Columbus hydrilla population has been observed in the northern most part of the lake that intersects with Highway 50. The shade and light interception previously provided by waterhyacinth are no longer impeding hydrilla development and growth in this location. Therefore, hydrilla population expansion is likely at Lake Columbus. To date, no control methods have been implemented to manage hydrilla populations on these three water bodies along the Tennessee

Tombigbee Waterway. Therefore, a “no action” method has been rated as poor because hydrilla has not been controlled (Table 2).

Noxubee National Wildlife Refuge

Hydrilla was found in the Noxubee National Wildlife Refuge at Lake Loakfoma (Table 1). Associated species growing with hydrilla include: American lotus (*Nelumbo lutea* Willd.) and coontail (*Ceratophyllum demersum*). The only control method performed at this water body was drawdown and was rated as good at the time of the survey (Table 2). Drawdown may be useful as short-term control. However, asexual reproductive structures such as tubers and turions may remain in the sediment and sprout after the water body is refilled.

Ross Barnett Reservoir

Hydrilla was found in the upper lake of the Ross Barnett Reservoir (Table 1). Associated species growing with hydrilla include American lotus (*Nelumbo lutea*) and alligatorweed (*Alternanthera philoxeroides* (Mart.) Griseb.). To date, 124 acres have been sprayed for hydrilla control using the aquatic herbicide fluridone. This control method has been rated as excellent because hydrilla shoots have been controlled (Table 2). Also, asexual reproductive structures such as tubers and turions have not been found at locations where the herbicide was applied.

Table 2. Visual ratings at the time of survey for each known control method applied at known locations of hydrilla and giant salvinia in Mississippi.

Location	Plant	Method	Agent	Rating
Lake Aberdeen	hydrilla	None	None	Poor
Lake Columbus	hydrilla	None	None	Poor
Noxubee National Wildlife Refuge	hydrilla	Physical	Drawdown	Good
Lake Aliceville	hydrilla	None	None	Poor
Ross Barnett	hydrilla	Chemical	Fluridone	Excellent
Wedgeworth Creek	hydrilla	Biological	<i>Cyrtobagous salviniae</i>	Poor

INVASIVES

The Invasive Status of Giant Salvinia and Hydrilla in Mississippi
Robles, et al

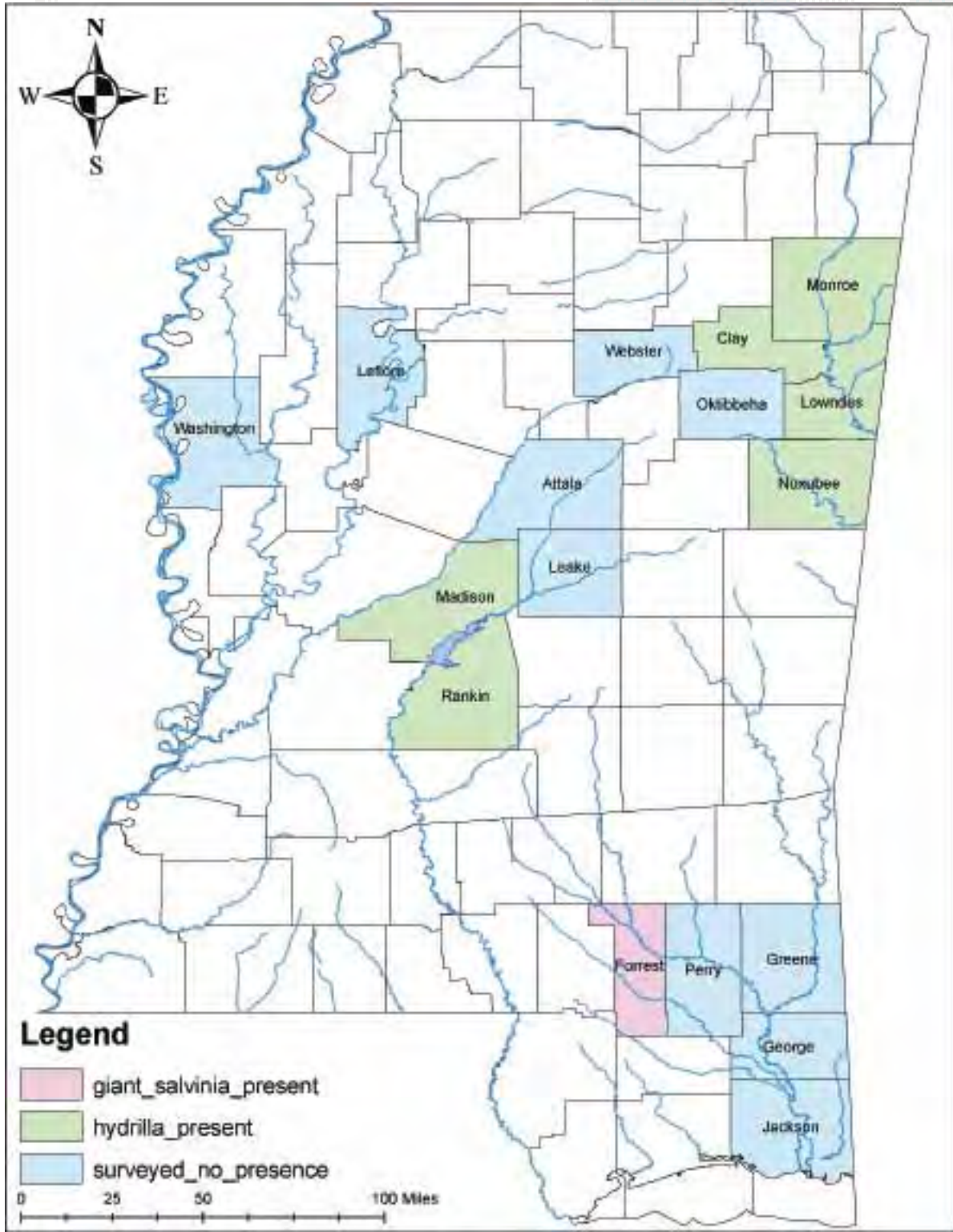

Figure 1. Status of hydrilla and giant salvinia in Mississippi according to the 2006 survey.

Giant Salvinia Status

Wedgeworth Creek

Giant salvinia was found in Wedgeworth Creek, a small creek that drains into the Leaf River (Table 1). Due to the heavy infestation of giant salvinia at this location and the potential to escape into a bigger water body, an extensive survey was performed at this location. Only the aquatic plant parrotfeather (*Myriophyllum aquaticum* (Vell.) Verdc.) was found as an associated species of giant salvinia at this location. In 2005, only the north portion of the creek was infested with giant salvinia. However, in 2006, giant salvinia has spread south, where it was found 124 meters from the Leaf River. At the time of the survey, 100% coverage of giant salvinia was reported under the bridge in Sims Road. Biological control has been performed in this area to suppress giant salvinia growth, but it still persists along Wedgeworth Creek. Therefore, this control method has been rated as poor because giant salvinia is still covering 100% of the water body surface (Table 2). An oxbow located west of Wedgeworth Creek was surveyed, but giant salvinia was not found.

Pascagoula River

In 2005, giant salvinia was found west of the Pascagoula River delta (Madsen et al., 2006). However, giant salvinia has not been found after hurricane Katrina in August 2005. An extensive survey was performed in 2006 east and west of the Pascagoula River, examining the north side of Bluff creek and other tributaries in this area. Apparently, the storm surge associated with Hurricane Katrina in August 2005 changed the water chemistry (salinity), limiting giant salvinia growth at this location.

Conclusions and Recommendations

Aggressive management of hydrilla and giant salvinia in Mississippi is highly recommended in order to prevent spread and heavy infestations in larger water bodies. For instance, hydrilla infestation in the Tennessee-Tombigbee Waterway currently does not limit boat traffic or cause a disruption in water supply. However, failure to manage known hydrilla infestations will result in future heavy infestations.

The implementation of other control methods, such as chemical control, to manage giant salvinia is highly recommended to prevent spread and escape into the Leaf River. Biological control alone will not adequately suppress the growth of giant salvinia.

Giant salvinia has not yet been eradicated in the Pascagoula River region, although the plant was not found during this survey. Bluff Creek, located north to the area surveyed and reported in 2005 with giant salvinia presence (Madsen et al., 2006), is a tributary that should be fully surveyed.

Acknowledgements

The authors would like to thank the Bureau of Plant Industry, Mississippi Department of Agriculture and Commerce for funding this survey.

Literature cited

ESRI. 2005. ArcGIS-ArcMap, 9.1. ESRI Inc. Redlands, California.

Madsen, J. D., R. M. Wersal, W. Robles. 2006. Distribution of hydrilla and giant salvinia in Mississippi in 2005. An Annual Report to the Mississippi Bureau of Plant Industry for 2005. GeoResources Institute Report 5002, 7 pp.



AGRICULTURE



Antibiotic Resistant and Pathogenic Bacteria Associated with Rain Runoff following Land Application of Poultry Litter

John P Brooks
USDA-ARS, Waste Management and Forage Research Unit

Agriculture and Ground Water Quality in a Sugarcane Area in São Paulo State, Brazil

Antonio L. Cerdeira, Maria C.P.Y. Pessoa, Denizart Bolonhezi, Marco A.F. Gomes, Claudio A. Spadotto, Manoel D. DeSouza, Vera L. Ferracini, Regina H.C. Queiroz, Vera L. Lanchote, Sonia C.N. Queiroz and Carlos F. Neto
Embrapa-Environment, Brazilian Department of Agriculture

Irrigation Water Conservation Through Use of Level Basins in Louisiana

Bill Branch and Glen Daniels
LSU Ag Center

Antibiotic Resistant and Pathogenic Bacteria Associated with Rain Runoff following Land Application of Poultry Litter

John P. Brooks
USDA-ARS, Waste Management and Forage Research Unit
810 HWY 12 E.
Mississippi State, MS 39762
662-320-7411
E-mail: jbrooks@msa-msstate.ars.usda.gov

ABSTRACT

Poultry rearing in the United States is approximately a thirty million dollar per year industry. To produce this large number of product, a by-product such as poultry litter is inevitable. The land application of poultry litter as an organic fertilizer is an ideal choice for the disposal of this high nitrogen, high organic waste. However, some precautions must be observed, particularly with regard to potential rain-mediated runoff of litter-related microorganisms following any large-scale precipitation events, such as those common to the Mississippi area. To investigate this phenomenon, poultry litter application will be simulated in a controlled greenhouse environment. Litter will be applied to Bermuda grass (*Cynodon dactylon*) plots held within runoff trays designed to simulate environmental conditions, by simulating slope, soil type, and climate. A rainfall simulator will be used to simulate precipitation events. Rainfall will be simulated on a weekly basis for a total of 4 consecutive weeks. Following each rain event, runoff and leachate samples will be collected for microbial analysis. Soil will be collected prior to the commencement of the experiment and following experiment termination. Total Heterotrophic Plate Count bacteria, antibiotic resistant bacteria, fecal coliforms, enterococci, staphylococci, *Clostridium perfringens*, and *Salmonella* spp. will all be investigated using both cultural and molecular methods. Select pathogens, indicator, and heterotrophic plate count bacteria will be selected for further genus typing and antibiotic resistance. In addition to the litter applied runoff trays, control trays in which no litter will be applied and chemical fertilizer applications will be used as comparison controls. Results from this experiment will lead to future in field application studies, under environmental conditions. These experiments will then be used to identify optimal field conditions necessary to achieve decreased potential for microbial runoff and subsequently provide much needed information to the area of litter application.

Keywords: Agriculture, Water Quality, Surface Water, Management and Planning

Introduction:

Land application of waste byproducts as fertilizer has been a common practice for man since the practice of land applying "night-soil" begun centuries ago. Wastewater treatment biosolids and manure now constitute the largest supplies of organic fertilizers. Manure from bovine, ovine, and poultry sources are some of the most common sources of organic fertilizers. These wastes are ripe with N, P, and other plant nutrients which make the application of these

manures as fertilizer the most efficient method of manure reuse. However, despite the presence of these nutrients, manure land application can create some potential environmental hazards. Runoff of manure borne bacterial, viral, and parasitic pathogens has been demonstrated in a few studies (Entry et al., 2000; Stout et al., 2005; Thurston-Enriquez et al., 2005; Ferguson et al., 2007). Though many of these pathogens are environmentally labile organisms, some such as spore forming bacteria can survive for extremely long

periods of time. Even fecal borne bacteria such as *Salmonella* and *Escherchia coli* can survive under relatively favorable environmental conditions (Jiang et al., 2002; Malik et al., 2004). In addition the presence of antibiotic resistance bacteria can compound the issue as potentially all manure borne bacteria (pathogenic and non-pathogenic) can harbor antibiotic resistance (both intrinsic and acquired). Horizontal transfer of mobile antibiotic resistance genes from one bacterium to another can potentially occur under environmental and in vivo conditions (Rensing et al., 2002; Dzidic and Bedekovic, 2003).

The purpose of this research was to identify the potential for manure borne bacteria to be horizontally transferred via surface water runoff following rain events. Runoff samples were collected from runoff plots and analyzed for the presence of a wide range of bacteria. Antibiotic resistance profiles were obtained from select isolates. Runoff samples were also collected from control plots without manure application.

Materials and Methods

Bermuda grass (*Cynodon dactylon*) was established in 3.1 sq ft troughs with non-sterile soil. Poultry litter (approximately 7 days old) was applied to the troughs at two organic fertilizer rates of 250 lb N, and 50 lb P per acre, a high and a low rate respectively. A third poultry litter treatment followed the 250 lb N treatment, however lime (CaO) was added at a 10% volume. Troughs with inorganic fertilizer (250 lb N, and 50 lb P per acre) were used as control fertilizer troughs. In addition, a trough with no fertilizer (organic or inorganic) applied was also used. Each trough was replicated in triplicate and placed onto carts in a randomized fashion. Troughs were held in a greenhouse from Dec. 06 through Feb. 07 and environmental conditions for optimal growth were met through the use of heat lamps and fans. Rain was generated via the use of a constructed rain simulator and was operated at 27 mm/hr. Rain events were as follows: 1, 3, 10, 17, and 25 days post application of litter, each lasting approximately 30 minutes. Each trough was rained upon equally and was raised to a height to simulate an approximate 3% slope.

Runoff water samples were collected from each trough following each rain event and were analyzed for microbial content including: Heterotrophic plate count bacteria (HPC), thermotolerant coliforms, total coliforms, *Staphylococcus*, *Enterococcus*, and *Clostridium perfringens* using modified standard methods. Antibiotic resistance profiles were generated from representative isolates. The Kirby Bauer method of assessing antibiotic resistance was used for antibiotic profiles of twelve antibiotics (Bauer et al., 1966).

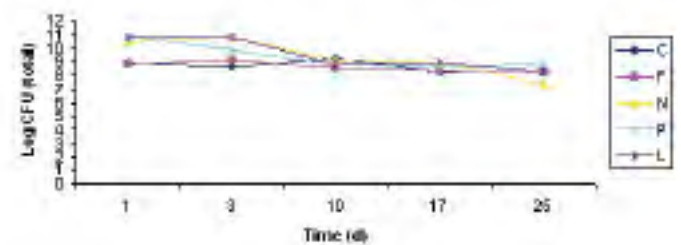

Figure 1. Heterotrophic plate count bacteria detected in runoff water samples. Values are presented as CFU present in the total runoff amount. C = Control troughs, F = Inorganic Fertilizer troughs, N = 250 lb/acre N poultry litter rate troughs, P = 50 lb/acre P poultry litter rate troughs, L = 250 lb/acre N poultry litter rate amended with 10% volume lime troughs.

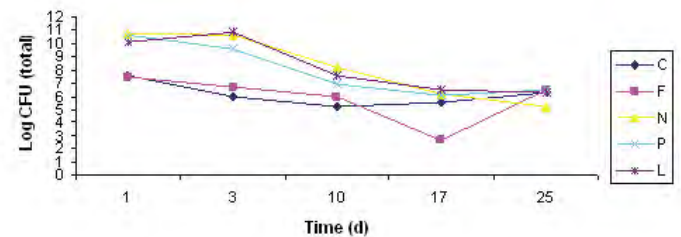

Figure 2. *Staphylococcus* detected in runoff water samples. Values are presented as CFU present in the total runoff amount. C = Control troughs, F = Inorganic Fertilizer troughs, N = 250 lb/acre N poultry litter rate troughs, P = 50 lb/acre P poultry litter rate troughs, L = 250 lb/acre N poultry litter rate amended with 10% volume lime troughs.

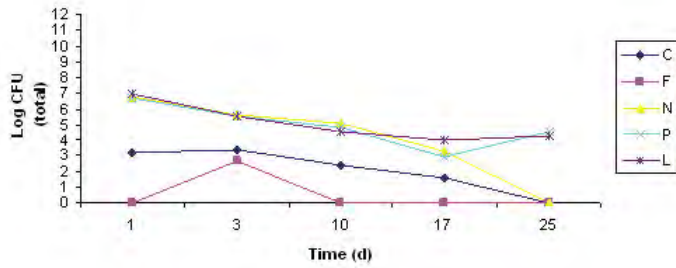

Figure 3. *Enterococcus* detected in runoff water samples. Values are presented as CFU present in the total runoff amount. C = Control troughs, F = Inorganic Fertilizer troughs, N = 250 lb/acre N poultry litter rate troughs, P = 50 lb/acre P poultry litter rate troughs, L = 250 lb/acre N poultry litter rate amended with 10% volume lime troughs.

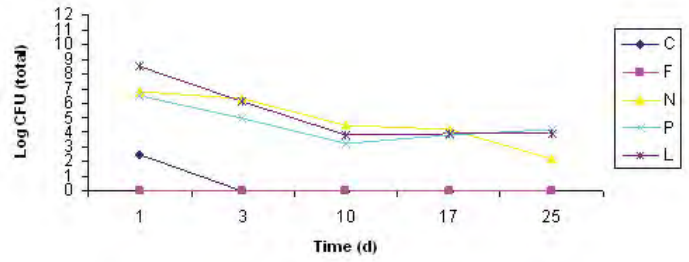

Figure 4. *Clostridium perfringens* detected in runoff water samples. Values are presented as CFU present in the total runoff amount. C = Control troughs, F = Inorganic Fertilizer troughs, N = 250 lb/acre N poultry litter rate troughs, P = 50 lb/acre P poultry litter rate troughs, L = 250 lb/acre N poultry litter rate amended with 10% volume lime troughs.

Results and Discussion

Overall an increase in the amount of bacteria detected in runoff was correlated with manure application (Figure 1). Troughs with poultry litter application yielded relatively high total amounts of manure borne bacteria such as HPC, *Staphylococcus*, *Enterococcus*, and *C. perfringens* (Figures 1, 2, 3, and 4 respectively). Both rates of manure application yielded these bacterial groups, with increasing totals associated with increasing manure rates. Chemical fertilizer, and no fertilizer controls yielded relatively less of these bacterial groups, up to 7 orders of magnitude less in the case of *C. perfringens*. These trends proceeded through the first 3 rain events and in the case of *C. perfringens* proceeded through the end of the rain events (25 days later). Although staphylococci and enterococci can both be found in the environment, the presence of enterococci can most likely be attributed to the presence of fecal contamination and is a fairly reliable indicator. Staphylococci on the other hand, can be readily present in non-impacted environments as many of these organisms are saprophytes. However, the overwhelming presence of these organisms associated with the land application of poultry manure lends credence to the idea that these could be used as potential indicators of poultry manure runoff. The majority of the bacterial groups associated with the poultry litter used in this study were staphylococci. Traditional fecal indicators such as coliforms and thermotolerant coliforms

yielded no such trends as these were present in runoff from both organic and inorganic fertilizer applications (Figure 5). As such these organisms would not be able to be used as indicators of poultry manure horizontal movement. Since the soil used in the troughs was collected from the environment and not sterilized prior to use, this was a possibility, as many soils are known to have detectable levels of these organisms due to agricultural practices involving both organic and non-organic fertilizers. This presence renders them unable to be used as suitable tracers of manure movement.

Antibiotic resistance patterns may serve as suitable indicators of poultry manure application. However depend-

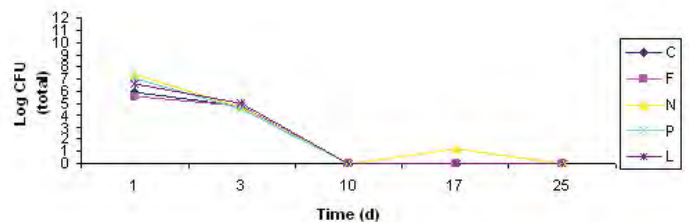

Figure 5. *Thermotolerant coliform* detected in runoff water samples. Values are presented as CFU present in the total runoff amount. C = Control troughs, F = Inorganic Fertilizer troughs, N = 250 lb/acre N poultry litter rate troughs, P = 50 lb/acre P poultry litter rate troughs, L = 250 lb/acre N poultry litter rate amended with 10% volume lime troughs.

ing on the source of the manure, the presence of traceable antibiotic resistance patterns may be difficult to use as some growers don't choose to use antibiotics in their feed regimens. Following the first and second rain events, antibiotic resistance patterns reflected more resistance (> 4 antibiotics) at a more consistent rate, consistent with the presence of manure. *Staphylococcus* isolates presented the most consistent antibiotic resistance patterns. Following the 3rd runoff event, antibiotic resistance patterns reflected that of the controls.

This research demonstrated that under favorable precipitation events (1 d post application) and conditions, poultry manure application can lead to microbial runoff. However the overwhelming presence of staphylococci, enterococci, and clostridia in poultry litter can lead to the exploitation of these organisms as indicators of poultry manure runoff. Antibiotic resistant bacteria were able to move with the runoff, however only a few isolates displayed antibiograms with resistance to greater than 4 antibiotics. This research will be repeated under field conditions using a similarly designed study to determine the effects of more realistic conditions.

References

- Bauer, A.W., Kirby, W. M. M., Sherris, J.C., and Turck, M. 1966. Antibiotic susceptibility testing by standardized single disk method. *American Journal of Clinical Pathology*. 45: 493-496.
- Dzidic, S., and Bedekovic, V. 2003. Horizontal gene transfer-emerging multidrug resistance in hospital bacteria. *Acta Pharmacol. Sin.* 24: 519-526.
- Entry, J.A., Hubbard, R.K., Thies, J.E., and Fuhrmann, J.J. 2000. The influence of vegetation in riparian filterstrips on coliform bacteria: I. Movement and survival in water. *Journal of Environmental Quality* 29:1206-1214.
- Ferguson, C.M., Davies, C.M., Kaucner, C., Krogh, M., Rodehutsors, J., Deere, D.A., and Ashbolt, N.J. 2007. Field scale quantification of microbial transport from bovine faeces under simulated rainfall events. *Journal of Water and Health* 5:83-95.
- Jiang, X., Morgan, J., and Doyle, M.P. 2002 Fate of *Escherichia coli* O157:H7 in manure-amended soil. *Applied and Environmental Microbiology* 68:2605-2609.
- Malik, Y.S., Randall, G.W, and Goyal, S.M. 2004. Fate of *Salmonella* following application of swine manure to tile-drained clay loam soil. *Journal of Water and Health* 2:97-101.
- Rensing, C., Newby, D.T., and Pepper, I.L. 2002. The role of selective pressure and selfish DNA in horizontal gene transfer and soil microbial community adaptation. *Soil Bio. Biochem.* 34: 285-296.
- Stout, W.L., Pachepsky, Y.A., Shelton, D.R., Sadeghi, A.M., Saporito, L.S., and Sharply, A.N. 2005. Runoff transport of faecal coliforms and phosphorus released from manure in grass buffer conditions. *Letters in Applied Microbiology* 41:230-234.
- Thurston-Enriquez, J.A., Gilley, J.E., and Eghball, B. 2005. Microbial quality of runoff following land application of cattle manure and swine slurry. *Journal of Water and Health* 3.2:157-171.

AGRICULTURE

Effects of Agriculture on Ground Water in a Recharge Area of Guarany Aquifer in Brazil

Antonio L. Cerdeira¹, Maria C.P.Y. Pessoa¹, Denizart Bolonhezi², Marco A.F. Gomes¹, Claudio A. Spadotto¹, Manoel D. DeSouza¹, Vera L. Ferracini¹, Regina H.C. Queiroz⁴, Vera L. Lanchote⁴, Sonia C.N. Queiroz¹, Carlos F. Neto³

¹Embrapa-Environment, Research Division of the Brazilian Department of Agriculture, C.P. 69, Jaguariúna, SP, Brazil. Phone: 55-19-3867-8771. cerdeira@cnpma.embrapa.br

²Agronomic Institute of Campinas, APTA, Ribeirão Preto, SP, Brazil.

³DAERP, Water Service Department, Ribeirão Preto, SP, Brazil.

⁴Pharmacy School of São Paulo University, USP, Ribeirão Preto, SP, Brazil

ABSTRACT

The region of Ribeirão Preto City located in São Paulo State, southeastern Brazil, is an important and highly mechanized sugar cane producing area. It is also an important recharge area of the Guarany aquifer, which provides water to several cities and rural communities in the region. Research has been conducted in this region since 1995 to assess the behavior of herbicides, such as atrazine, simazine, ametryn, tebuthiuron, diuron, 2,4-D, picloram, and hexazinone, applied in the area. Nitrate applied as nitrogen fertilizer was also evaluated. Espiraído watershed, located over the recharge area, was chosen for this study. Water samples were collected from seven wells located inside the watershed and from surface water of Espiraído stream. Other samples were taken from city wells located at the edge of the recharge area with exception of the control samples that were collected from downtown wells. Results have shown that no residue of herbicide was found in ground water wells and only ametryn was found at levels higher than the Maximum Concentration Level (MCL) of 0.1 µg/L in surface water of the watershed. However, nitrate was detected at levels close to the MCL of 10 mg/L in wells located in downtown, far away from the sugar cane area.

Key Words: Agriculture, Ground Water, Nonpoint Source Pollution, Solute Transport, Water Quality.

INTRODUCTION

Although it was generally accepted that pesticides would not leach to ground water, studies conducted especially in the last decade (Smith et al. 2001, Bower, 1990) have indicated that agrochemical leaching is an important factor of agricultural non-point-source pollution and some North American aquifers were contaminated with both inorganic and organic compounds including some pesticides (Williams et al. 1988).

Herbicide persistence in soil and leaching are potential sources of ground water contamination (Pessoa et al. 2003). The region of Ribeirão Preto city, São Paulo State,

located in Southeast of Brazil, is an important area for sugar cane production, with high level of herbicide and fertilizer utilization. This is also an important recharge area of the Guarany aquifer ground water, which extends to eight Brazilian states and part of Argentina, Uruguay, and Paraguay, with approximately 1,200,000 km². Geological studies in the region have identified a watershed, called Espiraído (Miklós and Gomes 1996), with high risk of ground water contamination. Certain areas of the Espiraído watershed are highly permeable sandy soil allowing leaching of agrochemicals applied in crops (Gomes et al. 1996).

Several analytical methods were developed using gas chromatograph/mass spectrometry (GC-MS) to detect and quantify herbicides used in the area in Brazil. (Lanchote et al. 2000, Souza et al. 2000, Souza et al. 2001, Cerdeira et al. 2000, Gomes et al. 2000).

As a tool to understand the interaction among cropping systems, herbicides, soils, and weather factors affecting the fate of the herbicides, various simulation systems can be used, including Chemical Movement in Layered Soils (CMLS-94) (Nofziger and Hornsby, 1994), Pesticide Root Zone Model (PRZM) (Carsel et al. 1995), and Ground water Loading Effects of Agriculture Management System (GLEAMS) (Leonard et al. 1987), among others. Several studies using CMLS-94 to evaluate the tendencies of tebuthiuron, diuron, atrazine, simazine, ametryn, 2,4-D, picloram and hexazinone herbicides in reaching ground water were conducted in the area (Cerdeira et al. 2002, Pessoa et al. 2003). This research was conducted because of the Espirado watershed vulnerability, and its vicinity was chosen to study herbicides and nitrates movement and potential contamination of the water.

MATERIALS AND METHODS

A survey conducted in the area has indicated that the herbicides atrazine, simazine, ametryn, tebuthiuron, diuron, 2,4-D, picloram, hexazinone and nitrate applied as nitrogen fertilizer, were frequently utilized and they were chosen for this study.

Surface and ground water were collected at four month intervals from seven wells located at the Espirado watershed and from six municipal wells located outside of the watershed at the vicinity of the recharge area, during the period of 1995 to 2006 (Table 1).

Herbicides Determination in Water

Water samples (1L) were collected. Herbicides measurements were made from 100 mL of water samples, filtered under vacuum through a membrane of 0.22 µm porosity. The filtrates were extracted with 12 mL

Table 1. Depths and localization of the wells.

Wells	Depths (m)	Localization (South and West)
São Sebastião ¹	197	21° 02' 59" and 47° 44' 09"
Palmares ¹	199	21° 10' 29" and 47° 45' 44"
São José ¹	236	21° 13' 25" and 47° 45' 40"
Recreio Internacional ¹	134	21° 11' 09" and 47° 43' 32"
Central ¹	79	21° 10' 55" and 47° 18' 01"
Portinari ¹	220	21° 09' 44" and 47° 44' 28"
W1 ²	53	21° 13' 40" and 47° 42' 05"
W2 ²	38	21° 14' 30" and 47° 42' 33"
W3 ²	8	21° 14' 49" and 47° 43' 07"
W4 ²	4	21° 14' 50" and 47° 43' 10"
W5 ²	9	21° 14' 42" and 47° 42' 53"
W6 ²	surface	21° 15' 47" and 47° 43' 43"
W7 ²	9	21° 14' 10" and 47° 43' 49"

¹Denotes municipal wells.²Denotes wells on the recharge area, from 1 to 7.

dichloromethane and shaken for one hour (Ballinova 1993, Durand et al. 1992).

After phase separation, 6 mL of the organic phases were transferred to conic test tubes and evaporated to dryness at 35 °C. The residues were dissolved in 200 µL of mobile phase and 100 µL were chromatographed on a Lichrospher 100 RP-8 column (particle 5 µm, 125 x 4 mm, Merck) using 0.05 M phosphate buffer, pH 5.5, and acetonitrile (73:27, v/v) as mobile phase. Triazine herbicides were detected at 220 nm, whereas tebuthiuron and diuron were detected at 254 nm. (Schlett 1991).

The recovery obtained with the extraction procedure was higher than 95% for all herbicides except simazine for which the recovery was 85.6%. Due to the enrichment in the

extraction procedure and the sensitive detection at the two wavelengths, it was possible to obtain a quantification limit of 0.02 µg/L for the herbicides studied. The method was linear over the range of 0.02 to 2.0 µg/L.

Nitrate was analyzed by Cadmium Reduction Method according to Greenberg, et al. 1992.

Simulation with CMLS-94 Model

The mathematical model of leaching CMLS-94 was used to understand the behavior of the chemicals on the environment. The input data required to use CMLS-94 were: a) crop cultural coefficient of sugar cane (K_c); b) soil type by depths - percent of organic carbon, density ($Mg\ m^{-3}$), volumetric content of water (%) on field capacity, on wilting point, and on saturation; c) weather - daily maximum and minimum temperatures, rainfall (varying between 1300 and 1500 mm/year) and evaporation (the potential evapotranspiration reaching 1000mm/year, based on the Thorntwaite method), d) herbicides properties- adsorption coefficient (K_{oc}) and soil half life ($t_{1/2}$); e) spraying - date and initial dose applied; and f) geographical coordinates (Table 1). K_{oc} and $t_{1/2}$ were evaluated from the soils collected in the area.

RESULTS AND DISCUSSION

Chemical analysis of tebuthiuron, diuron, atrazine, simazine, and ametryn revealed that no residues of these herbicides were detected in ground water. In one sole collection, ametryn residues at concentrations above the Maximum Concentration Level (MCL) (0.17 and 0.23 µg/L) were detected in samples acquired in two locations out of nine from the Espraiado stream. The acceptable maximum level for European standard is 0.1 µg /L.

Very low amount of nitrates residues were detected in ground water of the Espraiado area (Table 2), however, analysis of municipal wells have shown that nitrate levels were detected at higher concentration than the MCL of 10mg/L (Table 3) in downtown well. This well is located away from agricultural sites.

The results obtained by the CMLS-94 simulation (Figure 1) indicate that the applied herbicides did not reach the depth of the confined aquifer (40 m). Hexazinone was found at deepest depth, at 30.0 m. (Figure 1).

In relation to soils, there was a tendency of Quartzarenic Neosol (RQ) soil leaching more than Clayey Eutroferroc Red Latosol (LVef) and Psamitic Distrofic Red Latosol (LVd) (Figure 2).

Table 2. Average values of NO₃ (mg/L) during the years of 1996, 1997, and 1998 in ground water from wells located at the Espraiado watershed.

Wells	1996			1997			1998		
	May	Sep	Nov	May	Sep	Nov	Feb	Apr	Jun
W1	1.0	0.3	0.2	0.8	0.0	0.2	0.0	0.0	0.2
W2	1.0	0.2	0.3	0.5	0.2	0.3	0.3	0.2	0.3
W3	0.3	0.2	0.0	0.0	0.1	0.0	0.0	0.0	0.0
W4	0.6	0.4	0.5	0.7	0.4	0.5	0.5	0.3	0.5
W5	0.4	0.6	0.3	0.4	0.6	0.3	0.0	0.4	0.3
W6	0.8	0.7	0.5	0.6	0.3	0.5	0.2	0.3	0.4
W7	0.5	0.6	0.4	0.5	0.6	0.4	0.4	0.3	0.0

Table 3. Average values of NO₃ (mg/L) during the years of 2005 and 2006 in ground water from wells located at the municipal area of Ribeirão Preto city.

Wells	July 05	March 05	Dec 05	Mar 06	Jun 06	Oct 06
São José	0.5	0.8	0.5	0.2	0.6	0.6
Portinari	0.1	0.1	0.2	0.1	0.0	0.1
Palmares	0.1	0.5	0.3	0.3	0.2	0.0
S. Sebastião	0.3	0.3	0.5	0.2	0.6	0.4
R. Internac.	0.0	0.3	0.4	0.8	0.0	0.1
Central ¹	8.5	11.0	9.3	7.3	8.0	7.0

¹Well located in downtown away from the recharge area.

A non-confined superficial water table found in the watershed with depths varying between zero to 20 m increases the risk of ground water contamination particularly in sandy soil. Thus the simulated results indicate that there is a potential risk of few herbicides to enter in contact with the superficial water table and further investigation must continue in monitoring those risk areas.

CONCLUSIONS

Results have shown that no residue of herbicide was found in ground water wells. Only nitrate was detected at levels close to MCL of 10 mg/L in wells located in downtown

area, which is at further distance of the sugar cane plantations. Among the herbicides, only ametryn was found at levels higher than the MCL of 0.1 µg/L in surface water of the watershed. Simulation has shown that the herbicide hexazinone could reach the deepest depth, at 30.0 m, and the leaching was higher in sandy soils, Quartzarenic Neosol (RQ).

REFERENCES

Balinova A (1993) Solid-phase extraction followed by high-performance liquid chromatographic analysis for monitoring herbicides in drinking water. *J Chromatogr* 643:203-207.

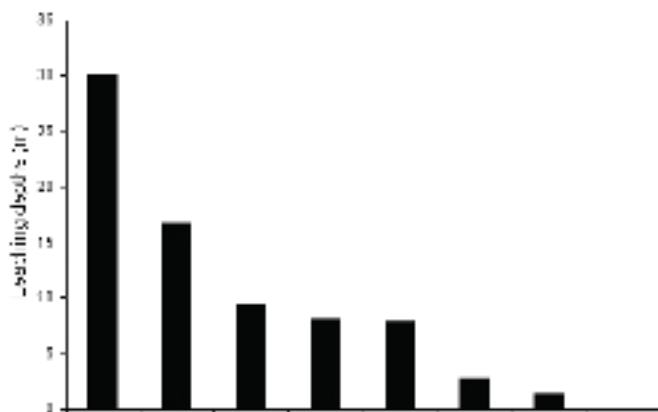

Figure 1. Herbicide depths reached in Quartzarenic Neosol (RQ) soil of the recharge area.



Figure 2. Depths reached by the herbicide hexazinone in different type of soils Quartzarenic Neosol (RQ), Psamitic Distrofic Red Latosol (LVd), and Clayey Eutroferroc Red Latosol (LVef). Simulated for 4 years.

Bouwer H (1990) Agricultural chemicals and ground water quality. *J Soil Water Conserv* 42:184-189.

Carsel RF, Mulkey LA, Lorber MN, Baskin LB (1985) The pesticide root zone model (PRZM): a procedure to evaluating pesticide leaching threats to groundwater. *Ecol Model* 30:49-69.

Cerdeira AL, Gomes MA, Pessoa MCPY, Queiroz RC, Bonato PS, Lanchote VL (2000) Tebuthiuron in soil and groundwater in sugar cane area in Brazil. *Boll Chim Igien* 51:51-57.

Cerdeira AL, Pessoa MCPY, Bonato PS, Queiroz RHC, Lanchote VL (2002) Resíduos e lixiviação do herbicida picloram em água, em área de cana-de-açúcar. *Rev Bras Herb* 3:75-81.

Durand G, Bouvot V, Barceló D (1992) Determination of trace levels of herbicides in estuarine waters by gas and liquid chromatographic techniques. *J Chromatogr* 607:319-327.

Gomes MAF, Spadotto CA, Luiz AJB, Neves MC (1996) In Método de classificação preliminar dos potenciais de infiltração e de escoamento superficial da água do solo: subsídio à avaliação do risco de contaminação por agroquímicos, Proceedings of the XIII Latin American Soil Science Meeting, Água de Lindoia, Brazil, Aug 4-8, 1996; Brazilian. Soil Science Society: Viçosa, MG, Brazil, 1996; CD-ROM.

Gomes MAF, Spadotto CA, Lanchote VL (2000) Ocorrência do herbicida tebuthiuron na água subterrânea da microbacia do córrego espraído, Ribeirão Preto/SP. *Pesticidas* 11:65-77.

Greenberg AE, Clesceri LS, Eaton AD (1992) Standard Methods for the Examination of Water and Wastewater, 18th Edition. American Public Health Association.

Washington, DC, USA. pp.1220.

Lanchote VL, Pierina SL, Cerdeira AL, Santos NAG, Carvalho D, Gomes MAF (2000) HPLC screening and GC-MS confirmation of triazine herbicides residues in drinking water from sugar cane area in Brazil. *Water Air Soil Poll* 118: 329-337.

Leonard RA, Knisel WG, Still DA (1987) GLEAMS: Groundwater Loading Effects of agricultural management systems. *Transactions of ASAE*. 30:1403-1418.

Miklós AAW, Gomes MAF (1996) Levantamento semidetalhado dos solos da bacia hidrográfica do Córrego do Espraído, Ribeirão Preto- SP. Embrapa/Meio Ambiente, Jaguariuna, SP, Brasil. 48p.

Nofziger DL, Hornsby AG (1994) CMLS-94-Chemical Movement in Layered Soils. Oklahoma: Department of Agronomy - University of Florida. 76p.

Pessoa MCPY, Gomes MAF, Neves MC, Cerdeira AL, Souza MD (2003) Identificação de áreas de exposição ao risco de contaminação de águas subterrâneas pelos herbicidas Atrazina, Diuron e Tebutiuron. *Pesticidas* 13:111-122.

Schlett C (1991) Multi-residue analysis of pesticides by HPLC after solid phase extraction. *Fresen J Anal Chem* 339 344-347.

Smith S, Johnson RM, Pepperman AB (2001) Formulation and tillage effects on atrazine and alachlor in shallow groundwater in upland corn production. *Bull Environ Contam Toxicol* 67:113-121.

Souza MD, Boeira RC, Gomes MAF (2000) Adsorção e dessorção de diuron em solos tropicais. *Pesticidas* 10:113-124.

Souza MD, Boeira RC, Gomes MAF, Ferracini VL, Maia

AGRICULTURE



AHN (2001) Adsorção e lixiviação de tebuthiuron em três tipos de solo. *Rev Bras Cienc Solo* 25:1059-1067.

Williams WM, Holden PW, Parsons DW, Lorber MN (1988) Pesticides in groundwater database. US Environmental Protection Agency: Washington, DC, USA, 30pp.

Irrigation Water Conservation Through Use of Level Basins in Louisiana

Bill Branch and Glen Daniels
LSU Ag Center
149 E. B. Doran Building
Baton Rouge, LA 70803-4505
225-578-2917
E-mail: bbranch@agctr.lsu.edu

ABSTRACT

Irrigation is standard practice for rice production in Louisiana. It is increasingly used to provide yield enhancement and insurance against periods of inadequate rainfall for cotton, corn and soybeans, even though drainage is the primary water management issue for crop production. Most irrigation pumps in Louisiana are powered by diesel engines and producer interest in improving irrigation efficiency is increasing as energy prices increase.

Land owners in many Southern states have been grading fields to low (<0.2%) slope to improve drainage and increase machine and irrigation water use efficiency. Some land owners are grading fields to zero slope (level-basin) for use in growing rice.

Measurement by the YMD Joint Water Management District, Stoneville, MS, (Epting, 2003-2004, Powers 2005-2006) of water used in irrigating rice indicates significant water savings on level basin fields compared to other rice field irrigation designs. Louisiana growers have also successfully used level-basin rice fields for crawfish production and for duck hunting. Growers would like the option of growing cotton, corn or soybeans on level-basin fields when market prices, input costs or weed conditions support these crops in preference to rice.

Cotton growers in Arizona have used level basins and have achieved high irrigation water use efficiencies. (Clemmens, 2000)

One of the advantages of level basins for rice, crawfish or ducks is the low flow rate pump capacity required to manage the system. Flood irrigation of cotton, corn or soybeans requires getting the water on the field and draining it quickly to avoid damage to the crop. Low pump capacity requires more time to irrigate, thus possibly leaving the root zone saturated too long and reducing yields of these crops.

Keywords: agriculture, conservation, economics, irrigation

Irrigation water use in the United States and in Louisiana

USGS, 1998, reports water use for irrigation in the United States peaked at 150,000 MGD in 1980 and declined to 134,000 MGD (about 10%) by 1995 even though total area irrigated remained about the same (58,000,000 acres). This decline in water use was attributed to increased irrigation efficiency and shifting acreage from dryer western states to eastern states with higher average rainfall.

USGS, 2004, reported a 2% increase in water use for irrigation to 137,000 MGD in 2000 with a 6% increase in acres irrigated to 61,900,000.

The US Department of Commerce, 1996, reported water use for irrigating agronomic crops in the conterminous states in 1988 as 84,182,177 acre-feet applied to 46,199,161 acres and in 1994 as 79,627,392 acre-feet applied to 46,418,380 acres. These data suggest a reduction in water use of 5.7% on 0.5% more acres. They report water

use for irrigation in 1979 at 93.1 million acre feet, or 17% more than in 1994.

The USDA, 2004, reported water use for agronomic crops in the United States in 2003 as 86,894,031 acre-feet applied to 52,583,431 acres and in 1998 as 97,335,291 acre-feet applied to 54,249,965 acres. These data suggest a reduction in water use of 12% on 3% fewer acres.

These surveys by three different agencies of different agricultural irrigation populations over different time frames continue to suggest increasing irrigation efficiencies. As competition for limited water supplies drives up the price of water in some states, irrigation water use for agronomic crops in those states should continue to decline. Whether or not that translates into increased demand for irrigation of those crops in states with plentiful supplies of water remains to be seen, especially in view of increased energy costs.

USDA, 2004, reports Louisiana as the 16th largest state in terms of acres of agronomic crops irrigated and the 19th largest state in terms of water used for irrigation. Surrounding states irrigate more acres and use more water. Texas irrigates the 3rd largest number of acres with the 4th largest amount of water. Arkansas irrigates the 4th largest number of acres with the 5th largest amount of water. Mississippi irrigates the 13th largest number of acres with the 18th largest amount of water.

DOTD, 2002, reported 890 MGD of water used to irrigate 620,000 acres of rice and 135 MGD of water used to irrigate 317,000 acres of crops other than rice in Louisiana in 1999. They report peak water use for irrigating rice at over 2000 MGD in 1980 and for other crops at nearly 80 MGD in 1975.

USDA, 2004, reports rice accounted for 9.8% of irrigation water used on agronomic crops in California in 2003, 11.9% in Texas, 40.5% in Mississippi, 56% in Arkansas, and 80.7% in Louisiana.

Rice irrigation water conservation

Table 1 provides a summary of the annual data reported by Epting (2003, 2004) and Powers (2005, 2006) for irrigation water used on a large number of Mississippi rice fields by type of irrigation. "Contour" and "Straight" in the

column headings refer to levees used for flood irrigation. The straight levees result from precision-graded fields. "MIRI" refers to multiple inlet rice irrigation where a polyethylene tube is run over the interior levees and delivers water to each paddy at the same time as opposed to contour and straight levee irrigation where water is delivered to the first paddy and from there to lower paddies in succession through gates installed in the levees. Data include annual "feet" of water used for irrigation and number of "fields" surveyed in the four years.

Contour levee		Straight levee		Multiple inlet		Level basin	
feet	fields	feet	fields	feet	fields	feet	fields
3.69	39	3.06	67	2.34	20	1.48	21

Introduction to level-basin design and performance

Dedrick, Erie and Clemmens, 1982, provide a comprehensive discussion of level basin design, maintenance and operation.

Clemmens, 2000, states that smaller basins are needed for heavier soils and that under some soil and climatic conditions, surface drainage is needed. He refers to drain-back designs which reduce both the initial earth moving cost to establish the fields and the time required to complete an irrigation while not reducing drainage capabilities. He mentioned common flow rates of 350 l/s to 500 l/s (5400 gpm to 8000 gpm) for a series of 4-hectare (10 acre) basins.

Numerous papers provide detail on designing fields for level-basin irrigation. Clemmens and Strelkoff, 1979, extended existing solutions for irrigation stream advance to level basins. Clemmens and Dedrick, 1981, 1982, discuss distribution uniformity calculations appropriate to the infiltration characteristics of the soil. They provide design limits for level basins where soil infiltration characteristics are matched with basin length and unit flow rate. Their solutions are for flat basins with no furrows, beds or corrugations irrigated from a line source along one side of the basin.

AGRICULTURE

Irrigation Water Conservation Through Use of Level Basins in Louisiana

Branch and Daniels

Bucks and Hunsaker, 1987, measured water use on wheat irrigated at three levels (replacement of 100%, 75% and 50% of expected ET) on 12 blocks each of two different lengths—251 m and 190 m (825' and 625'). The soil varied from a sandy loam to a sandy clay loam. The water delivery rate ranged from 153 L/s to 164 L/s (2,425 gpm to 2,600 gpm). A total of about 4 hectares (9.2 acres) was irrigated. Water distribution uniformity was above 85% for all three irrigation levels with variations in land elevation more significant than length of block irrigated. The irrigation application efficiency was higher for the dry treatment while crop water use was more efficient in the wet treatment. Spatial differences suggested that soil water variables should be measured at distances less than 15m to 30m (50' to 100'). In a separate paper on this research, Hunsaker and Bucks, 1987, reported significantly increased yields for the wetter treatments and no effect on yields from length of irrigated blocks. Yield variability within the irrigated blocks was less for the wetter treatments. Their recommendation for irrigating a heterogeneous soil in an efficient level-basin field was to schedule irrigations at near full ET.

Martin and Eusoff, 2000, reported on irrigation of seven level basins designed with drain back capability. The first six basins were 3.6 ha to 4 ha (9 acres - 10 acres) in size and the seventh basin contained 6.0 ha (14.7 acres). The soil was a mix of silt loam and silty clay loam. Flow into basin 1 was 0.24 m³/s (3850 gpm) and required 4.5 hours to complete the irrigation. Flows into lower basins were as high as 0.84 m³/s (13,470 gpm). Irrigation of basins 1-6 required 21.5 hours.

Flow rates of the wells monitored by Powers, (2006), ranged from 242 gpm to 2,819 gpm (15.3 l/s to 178 l/s). Flow rates per acre irrigated averaged 16.32 gpm-acre (2.54 l/s-ha) for 141 observations.

Concerns over use of level basins to irrigate crops sensitive to water logging

Cautions on use of level basins for irrigation of crops other than rice are numerous. Burt, 1995, suggests that level basins are not suitable for soils with very low intake rates. He reports level basins have been primarily used for fields rang-

ing from 2 acres to 15 acres and up to 30 acres in size, because of the high water flow rate requirements. CAST, 1988, reports that level basins are generally not used in areas with high rainfall except for rice, although for crops sensitive to ponded water, furrows might be used.

Hardjoamidjojo, Skaggs and Schwab (1982) compared studies in Ohio, India and Iowa of corn yield effects from inundation using DRAINMOD to calculate a stress day index.

Evans, Skaggs and Sneed (1990) added a normalizing approach to reduce the effect of the crop susceptibility factor to the level of stress induced by inundation for corn and soybeans. Evans and Skaggs (1993) tested relative yield and stress day index models for corn and soybeans to predict yield response to excess or deficient soil moisture conditions. Evans, Skaggs and Sneed (1997) developed relative yield models for corn and soybeans subjected to high water tables. Hester and Nussbaum, (2006) reported use of DRAINMOD in Missouri to estimate 25% and 26% yield loss in soybeans for each day of water logging at pod fill and pod development stages of growth.

Griffin, 1990, subjected MG 7 soybeans at the Rice Research Station near Crowley, Louisiana, to flooding for varying lengths of time to determine effects on yield. He concluded that flooding longer than 48 hours could result in significant yield loss.

Linkemer, 1995, found 30% to 90% yield reductions in Louisiana soybeans at the V2, R1, R3 and R5 growth stages due to water logging.

Level-basin experience in Louisiana

Rice has traditionally accounted for 60% of the irrigated acreage of agricultural crops grown in Louisiana, and for 75% or more of the irrigation water used. Cotton, corn and soybean acreage accounts for most of the irrigated acreage not devoted to rice. Annual average rainfall in Louisiana ranges from 55 inches in the Southeast to 45 inches in the Northwest, so that rapid drainage of excess rainfall from fields planted to cotton, corn and soybeans has always been the primary concern. Irrigation for these crops is seen as insurance against no-rainfall periods during the growing season.

Most of the cotton, corn and soybean acreage is in Northeast Louisiana between the Ouachita and Atchafalaya Rivers on the west, the Mississippi River on the east and the Arkansas state line to the north. Many of the farmed soils are cracking clays, labeled by USDA NRCS as Alligator, Sharkey, and Tensas. Soil texture variability within each field is high. Field capacity may be above 50% and wilting point near 35%. The terrain is usually flat. Rice has been planted on a significant acreage in this area during the last 30 years.

Much of the land has been precision graded to enhance drainage and irrigation. Field sizes typically range from 40 acres to 80 acres. Most irrigation is from wells. Typical wells are 120' deep and deliver 2000 gpm to 2500 gpm. Static water levels are about 50' below the surface and seasonal drawdown is about 1'. Concerns with salinity of ground water raise concerns about irrigating rice, corn and some soybean varieties.

Some fields have been graded to a zero slope in both directions (level basin). Several thousand acres of level basin fields are in use in Concordia Parish between the Tensas, Black and Mississippi Rivers. These fields were designed for rice production and some are also used for crawfish production and for duck hunting.

Field Design and Operation

Farm managers in Concordia Parish have worked with the County Agent for many years to host soybean, rice and wheat variety and pesticide trials, research verification fields, and educational workshops and tours for county agents, agricultural agency and agri-business staff, and farmers. Their field layouts typically include one well to supply four 80-acre fields. The level fields have interior water supply ditches on three sides. One long side is left open for machine traffic. A typical field is depicted in Figure 1.

This design provides a very high level of machine and cropping efficiency. Net area inside field roads, exterior levees and interior supply ditches is about 76 acres out of a gross 80 acre block. By comparison, the net acreage on the same fields graded to a slope may range from 72 acres to 74 acres after deducting land required for the interior levees.

Water is supplied from a diesel engine-powered well through underground pipe to a 12" riser and alfalfa valve in each field. The riser supplies water to the interior perimeter supply ditches. Water in the perimeter ditches then flows into "spin" ditches which are dug with a PTO-powered rotating blade and connect the perimeter supply ditches. Once all the perimeter supply ditches and the spin ditches are full, water flows out onto the field surface. The opposite sequence occurs when the field is being drained.

Well pump capacities usually range from 1700 gpm to 3200 gpm. The 1700 gpm well supplies 320 acres at a rate of less than 6 gpm-acre. The "stronger" 3200 gpm well supplies 10 gpm-acre. Each field has one to three 15" drains. Some drains discharge to lower fields and others to natural drains. These pumping flow rate capacities work well for rice, crawfish and duck hunting but are far less than those recommended for level basin irrigation of crops sensitive to water logging, such as cotton, corn or soybeans.

In some fields, the slopes on the 80 acre fields are in the ¼ mile direction and in some fields the slopes are in the ½ mile direction. An 80 acre sloping field may have as few as two or as many as 15 interior levees when used for rice production.

Soils are typically classed as Alligator silty clay, or Tensas and Sharkey clays (USDA SCS, 1988), with 40% to 90% clay. Surface cracks begin to appear within days of irrigation or rainfall.

Allen and Braud, 1965, reported on infiltration tests of a cracked Sharkey clay soil. Most of the soil moisture change took place in the top 8" (203 mm) to the depth of the cracks. At an initial soil moisture content of 34.8%, one inch (25.4 mm) of water was applied in less than one minute and two inches (50.8 mm) of water required 18 minutes. When the initial soil moisture content was 40%, one inch of water was applied in 30 minutes and two inches required more than 26 hours.

USDA-NRCS, 1997, provides average intake time on an intake family 0.1 soil for one inch of water as 170 minutes and for 2 inches as more than 10 hours, with up to a 40% decrease in intake time for a cracked soil. They suggest fur-

AGRICULTURE

Irrigation Water Conservation Through Use of Level Basins in Louisiana

Branch and Daniels

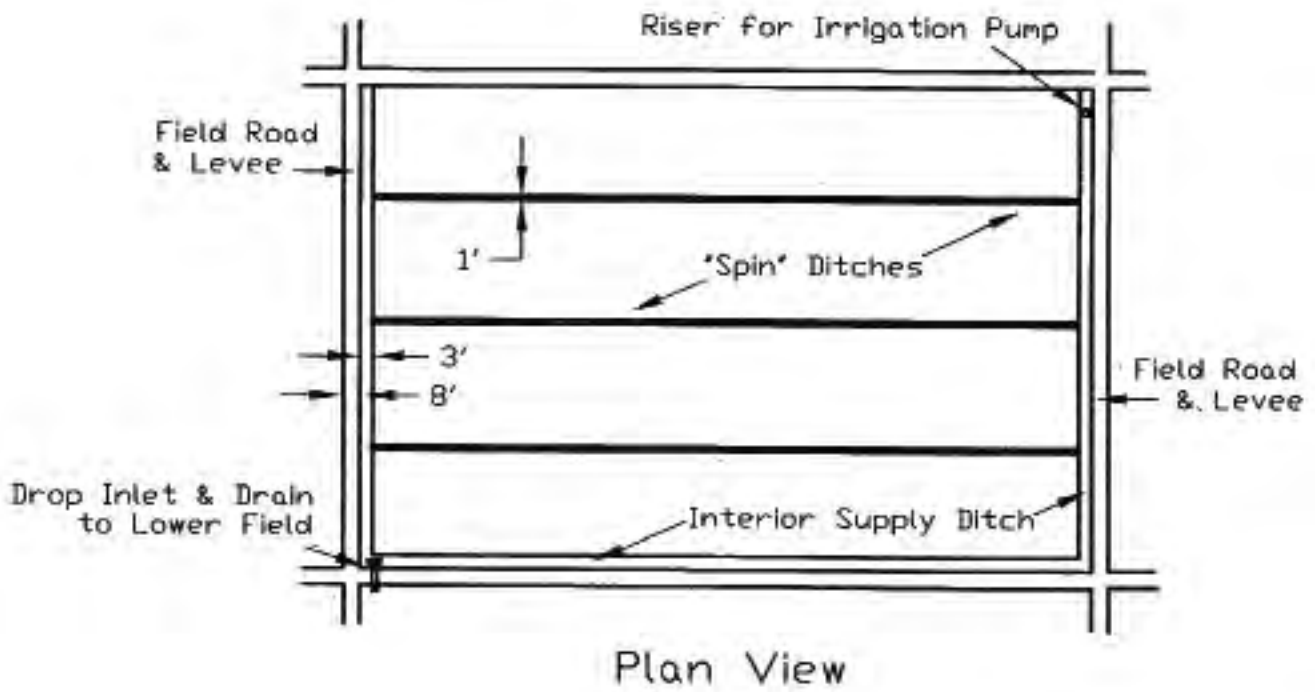

note: Exaggerated Scale

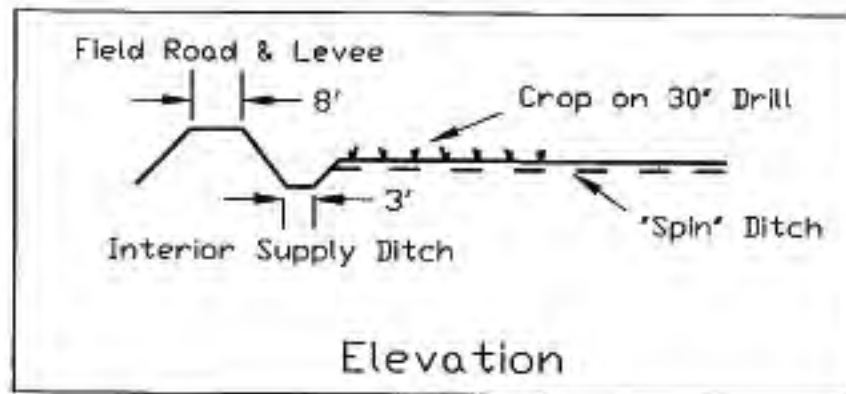

Figure 1. Field design.



Figure 2. Location of fields used in 2005-2006.

rows on level basins for cotton and corn. Factors opposed to use of level-basins are humid climate, low continuous flow rate and variable infiltration rate.

Results of Cotton Irrigation Trials

For the 2005 and 2006 crop years, cotton was grown on the 25 acre field depicted in Figure 1 and labeled 2-8 in the northwest corner of Figure 2. The County Agent secured assistance from LSU AgCenter faculty, area farm consultants, agribusiness managers and farmers to grow the crop. The well supplies two fields (2-8 and 2-10) totaling 65 acres with a flow rate of 1,600 gpm. For the 25 acre cotton field, this results in a 64 gpm-acre capacity. Shallow (3" furrows) were pulled in the 900 foot direction on 38" centers and three spin ditches were pulled across the field perpendicular to the rows at about 225' intervals. The Arkansas Irrigation Scheduler was used to initiate irrigations at a soil moisture depletion of 2".

For the 2005 crop season, the field was irrigated as it would have been for rice. The pump delivered water through a riser in the northeast corner of the field. The water spilled into the interior supply ditch, over 4,000' long, and began to fill it. Water was over the top of the cotton row adjacent to the riser while it was still a foot lower than the cotton on the far northwest corner of the field. The first irrigation used 5.3"

of water to cover the field in 38 hours. The second irrigation used 4.6" of water in 32 hours.

For the 2006 crop season, a 15" diameter polyethylene tube was attached to the riser and strung across the north side of the field (the side with no interior ditch). Sliding gates were installed on 114" centers and used to "border" irrigate. A backhoe was used to try and block the spin ditch outlets into the interior supply ditches and force irrigation water to flow down the row across the spin ditches. Water tended to move around the dirt and flow into the supply ditches. The dirt was removed after the first irrigation to avoid blocking drainage in case of a heavy rain. The first irrigation used 5.4" of water to cover the field using multiple sets in a total of 38 hours. The second irrigation used 4.5" in 32 hours and the third irrigation used 5.1" in 36 hours. Water flow rate down each bay was on the order of 120'/hour to 150'/hour so that each set watered out in less than 8 hours.

Table 2. Water used irrigating cotton during 2005 and 2006 seasons.

	Irrigation	1	2	3
Irrigate by filling supply ditches as designed	Inches	5.3	4.6	
	Hours	38	32	
Poly tubing and gate for border irrigation	Inches	5.4	4.5	5.1
	Hours	38	32	36

Results of Soybean Irrigation Trials

Six fields totaling approximately 324 acres were instrumented with flow meters for the 2006 season. Two fields (2-19 and 2-20) and a temporary weather station are located approximately 1 mile east of the other four fields (2-9, 2-10, 2-11 and 2-12). All fields were drilled on 30" centers. Poly tubing (15" diameter) was used to distribute irrigation water in each field. Sliding gates were installed to aid in controlling irrigation water flow in multiple sets on every other middle on one sloping field (2-20), every third middle on two sloping fields (2-10, 2-19) and one level-basin field (2-12)

AGRICULTURE

Irrigation Water Conservation Through Use of Level Basins in Louisiana

Branch and Daniels

and at different locations on two of the level-basin fields (2-9 and 2-11). Pump flow rates averaged 1600 gpm. Flow rates through the gates ranged from 10 gpm to 30 gpm. Each set used 50 to 80 gates depending on distance from the pump. One field was irrigated once (2-12), two fields were irrigated twice (2-9 and 2-11), and three fields were irrigated three times (2-10, 2-19 and 2-20). Irrigation was begun on three fields (2-12, 2-19 and 2-20) one or two additional times and stopped because of rainfall. The sets where irrigation was started and stopped before completion, received more water than the sets in the rest of the field. Subsequent irrigation of each field would then have begun with differing soil moisture depletions in the field. The Arkansas Scheduler was used on each field to trigger the need to irrigate modified by observed condition of soil and beans. The first irrigation on each field occurred at a soil moisture depletion of less than 2" and the second at 2" to 4". Multiple rain gages were used to increase accuracy of and to reduce spatial variability of rainfall data. Sand bags were used on field 2-9, 2-11 and 2-12 in an effort to try and force water down the drill over the spin ditches to no avail. Unsuccessful attempts were made to measure water leaving fields 2-10, 2-11 and 2-12.

Field 2-20 is rectangular, contains 74.1 acres and is graded to a 0.2% slope in the ¼ mile direction. It was in rice in 2005. The 8 interior ½ mile long levees used for rice were pulled down and the beans were drilled in the ¼ mile direction. The rice levees were not adequately removed so some ponding occurred on the high side of each with some damage to the beans resulting from water ponding after each irrigation or rain. This field was used for variety trials with resulting variation in maturity and differing harvest dates. A half mile of poly tubing was used with sliding gates in every other middle. Irrigation was begun five times but terminated when rain occurred at the end of the first day on three occasions. Four days were required to complete each full irrigation at a pump flow rate ranging from 1200 gpm to 1700 gpm. The gates allowed irrigating in sets so that no set took more than 12 hours. The two full irrigations used 4.5" and 5.3". The first irrigation occurred at a soil moisture depletion of 1.83" and the second at 2.79". The three additional irrigations which were begun and halted because of rainfall used a total of

2.2" of water. More tail water ran off in the second irrigation and the soil was drier and soil cracks were wider. Two manual rain gages were used.

Field 2-19 is rectangular on three sides and irregular on the end next to a natural drain. It contains 56.2 acres. It is graded to 0.2% in the ½ mile direction, was drilled in the half mile direction and was in rice last year. The 15 interior rice levees were fairly well pulled down but some ponding occurred on the high side with minor damage to the beans from water ponding after each irrigation and rainfall event. The weather station and an et gage were installed at the down stream end of the field. A ¼ mile of poly tubing was run in the ¼ mile direction with gates installed in every third middle. Three irrigations used 4.3", 4.2" and 4.3" of water. The first irrigation occurred at a soil moisture depletion of 1.51", the second at 4.01" and the third at 4.78". Two additional irrigations were begun and halted because of rainfall using a total of 1.9" of water. Three days were required for each full irrigation.

Field 2-10 is rectangular, contains 37.8 acres and is sloped in two directions. The slope in the ½ mile direction is 0.01% and in the 1/8 mile direction is 0.03%. There was some high ground in the center of the field so the grades were not completely uniform, but this did not seem to negatively affect the irrigation. Beans were drilled in the 1/8 mile direction. A half mile of poly tubing was installed with gates in every third middle. This field was in soybeans last year. It took 2.5 days to irrigate. The first irrigation used 3.8", the second used 2.9' and the third used 2.4" of water. The three irrigations occurred at a soil moisture depletion of 1.63", 2.06" and 2.12". Tail water from Field 2-10 flowed out to a drain on the first irrigation but was directed to field 2-11 which is downstream for the second and third irrigation.

Field 2-11 is a level-basin field and is a mirror image of the upstream Field 2-10. It has an irrigation water supply ditch running on three sides. A half mile of poly tubing was installed along the only side (south) with no supply ditch. Beans were drilled in the half mile direction. Ten spin ditches were dug in the 1/8 mile direction at different spacings. Three gates were installed at each spin ditch. Sand bags were used to plug the other ends (north) of the spin ditches

for the first irrigation. This did not prove effective. Water continued to seep out of the riser and kept several drills near the poly tubing wet after the irrigation was finished. Because the poly tube was on the undrained side of the field and the drills were parallel to the poly tubing, these rows stayed wet with subsequent yellowing and probable yield loss. The end of the poly tube was opened to drain the tubing and partially alleviate the wet area. The second irrigation was run with the end of the tubing open discharging some water into the supply ditch. This increased the time and amount of water required for the irrigation. Some of the water pumped into Field 2-11 flowed into the ditches for Field 2-12. The first irrigation used 3.6" of water and the second used 5.3". The first irrigation was begun at a soil moisture depletion of 1.59" and the second at 3.72". Each full irrigation required about 30 hours. A third irrigation was begun but halted because of rainfall after using 1.9".

Field 2-12 is level and includes 58.42 acres. It is 1/2 mile wide. One end is less than 1/4 mile long and the other is more than 1/4 mile long because of a natural drain on one side. Beans were drilled in the short direction. This field was used for variety trials with resulting variation in maturity. There were some low areas in the field which held water longer than the rest of the field. There were 5 spin ditches traversing the field in the half mile direction and a sixth spin ditch covering about half the field next to the natural drain. The low areas allowed water to stand on some of the beans resulting in yellowing and probable yield loss. The irrigation required three days and used 4.1" of water. It was begun at a soil moisture depletion of 1.51". A second irrigation was begun at a soil moisture depletion of 3.73" and used 2" of water before being halted for rainfall.

Field 2-9 is a level field containing 61.2 acres. It borders the same natural drain and shares a levee with Field 2-12. It is 1/4 mile wide and varies from 1/2 mile long on the long side to about 3/8 mile long on the short side. The beans were drilled in the long direction. Six spin ditches were run in the 1/4 mile direction across the drill and four shorter ditches run across the short end of the field. The riser was located at the third spin ditch from the top of the field. A poly tube was laid in this spin ditch and gated to irrigate the top 1/5 of the field

or the bottom 4/5 of the field. Sandbags and scoops of dirt from a backhoe were used to try and plug the ends of the spin ditches and force the water down the drill across the spin ditches. The water ran over the sand bags and washed around the piles of dirt. Three days were required to irrigate this field and some of the beans, especially on the 1/2 mile long drills were wet for the entire irrigation with probable loss of yield. The first irrigation was begun at a soil moisture depletion of 1.51" and used 4.1" of water. The second irrigation was begun at a soil moisture depletion of 4.51" and required 4.4" of water.

Summary-Cotton

The use of poly tubing and gates to "border" irrigate a level basin cotton field in 2006 made little difference in the amount of water used and the time required to complete an irrigation as compared to the same field irrigated as designed for rice in 2005. The advantage to using the poly tubing and gates was in limiting time that cotton in each set was in standing water. For the 2007 season, consideration is being given to spacing spin ditches at 100' centers or plowing spin ditches parallel to the rows to act as "water furrows", pulling the rows higher or planting on a 60" bed, and to filling the interior supply ditches at a lower flow rate until they are full, then increasing flow rate to complete the irrigation. Water flows through the cracks in the soil at least 15'. It may be possible to irrigate water furrows spaced at 30' centers. For the same reason, there appears to be no need to run water closer to the side ditches than 15'.

Summary-Soybeans

The sloping fields were easier to irrigate than the level fields. The two sloping fields in rice last year (2-19 and 2-20) had some ponding above the old rice levees. The field with two slopes (2-10) was the easiest to irrigate.

Flow rates per acre on two level fields (2-9 and 2-12) and on two sloping fields (2-19 and 2-20) ranged from 22 to 28 gpm-acre. These fields required multiple sets of 12 hours to 36 hours over 3 days to 4 days and sustained probable yield loss due to ponding. Flow rates on one level field (2-11) and one sloping field (2-10) ranged from 42 to 44 gpm-acre.

AGRICULTURE

Irrigation Water Conservation Through Use of Level Basins in Louisiana

Branch and Daniels

Sets were as short as 6 hours and irrigations took 2 days to 3 days. Some ponding and probable yield loss occurred on 2-11 because of the location of the poly tube.

The first irrigation on each of the six fields occurred at a soil moisture depletion of 1.58" to 1.83" and required 3.6" to 4.5" of water. Water required for the first irrigation on the level fields averaged 4.02" at depletions of 1.51' to 1.59". Water required on the first irrigation of the sloping fields averaged 4.2" at depletions of 1.51' to 1.83". While the highest water use occurred at the highest depletion of 1.83", there was little difference in water use at the lower depletions.

The second irrigation on five fields occurred at soil moisture depletions of 2.06' to 4.51". Water used on the two level fields averaged 4.85" at depletions of 3.72" to 4.51". Water used on the three sloping fields averaged 4.13" at depletions of 2.06" to 2.79". The third irrigation of two sloping fields averaged 3.13" at depletions of 1.86" to 2.12". Using higher soil moisture depletions as the crop matures increased water use per irrigation but reduced the number of irrigations thus lowering total irrigation cost. Allowing soil moisture depletion to reach higher levels may have reduced yields.

Filling the perimeter supply ditches on the level fields prior to irrigating, locating spin ditches at a closer (100') spacing, and pulling up wide beds (60" to 72") with a deeper "middle" to serve as a water furrow, or pulling water furrows parallel to the drill rather than using spin ditches across the drill, appear to be the best practices to reduce irrigation set times on level fields.

Using a marginally higher pump flow rate reduced set time, labor and management, but not the amount of water used.

If sliding gates are used, they need to be spaced no closer than every 4 drills (120") and could probably be spaced further apart, up to 30' on cracking clays.

Yield effects from water logging or higher soil moisture depletions are unknown. Use of DRAINMOD may allow prediction of yield effect from various periods of inundation at specific growth stages.

References

- Allen, J. B. and H. J. Braud, Jr. 1967. 'Buckshot' Soils: a peculiar problem in irrigation. *Louisiana Agriculture*, 10, pp 6-7.
- Bucks, D. A. and D. J. Hunsaker. 1987. Water use variability in irrigated level basins. *Transactions of the ASAE* 30(4):1090-1098.
- Burt, C. M. 1995. *The Surface Irrigation Manual*. Waterman Industries, Exeter, CA. Rose Printing Co., Inc. p 3.7
- Clemmens, A. J. and T. Strelkoff. 1979. Dimensionless advance for level-basin irrigation. *Journal of the Irrigation and Drainage Division, ASCE*, Vol 105, No. IR3, pp 259-273.
- CAST. 1995. *Effective use of water in irrigated agriculture*. Report No. 113, p 27.
- Clemmens, A. J. and A. R. Dedrick. 1981. Estimating distribution uniformity in level basins. *Transactions of the ASAE*. Vol 24, No. 5, pp 1177-1180, 1187.
- Clemmens, A. J. and A. R. Dedrick. 1982. Limits for practical level-basin design. *Journal of Irrigation and Drainage Engineering, ASCE*, 108(2):127-141.
- Clemmens, A. J. 2000. Level-basin irrigation systems: adoption, practices, and the resulting performance. *Proceedings of the 4th Decennial National Irrigation Symposium, ASAE*, St. Joseph, MI. pp 273-282.
- Dedrick, A. R., L. J. Erie and A. J. Clemmens. 1982. Level-basin irrigation. In *Advances in Irrigation*, Volume 1, pp 105-145. Edited by Daniel Hillel. Academic Press, New York.
- DOTD, 2002. *Water use in Louisiana, 2000*. Department of Transportation and Development Water Resources Special Report No. 15. Baton Rouge, LA.

Epting, Josh. 2003. Irrigation water use and water level survey annual report. YMD Joint Water Management District. Stoneville, MS.

Epting, Josh. 2004. Water use in the Mississippi Delta. YMD Joint Water Management District. Stoneville, MS.

Epting, Josh. 2004. Water use in the Mississippi Delta. YMD Joint Water Management District. Stoneville, MS.

Evans, R. O., R. W. Skaggs and R. E. Sneed. 1990. Normalized crop susceptibility factors for corn and soybean to excess water stress. ASAE Vol 33(4): July-August.

Evans, R. O., R. W. Skaggs and R. E. Sneed. 1991. Stress day index models to predict corn and soybean relative yield under high water table conditions. ASAE Vol 34(5): September-October.

Evans, R. O. and R. W. Skaggs. 1993. Stress day index models to predict corn and soybean yield response to water table management. 15th International Congress of ICID, Workshop on Subsurface Drainage Simulation Models.

Griffin, J. L. 1990. Effect of flooding on soybeans. LSU Ag-Center, Crowley.

Hardjoamidjojo, S., R. W. Skaggs and G. O. Schwab. 1982. Corn yield response to excessive soil water conditions. Transactions of ASAE, Vol 25(4)922-927, 934.

Hester, J. and M. Nussbaum. 2006. Sub-surface drainage and irrigation. Presentation at the University of Missouri Bootheel Irrigation Workshop, December, 12, 2006. Portageville, MO.

Hunsaker, D. J. and D. A. Bucks. 1987. Wheat yield variability in irrigated level basins. Transactions of the ASAE 30(4):1099-1104.

Linkemer, G. 1995. Quantification of waterlogging stress on late planted soybeans. Unpublished thesis, LSU Department of Plant Pathology and Crop Physiology, Baton Rouge

Martin, E. C. and T. H. Eusoff. 2000. Saving water using drain-back level basins. Proceedings of the 4th Decennial National Irrigation Symposium, ASAE, St. Joseph, MI. pp 567-572.

Massey, J., M. C. Smith and J. Thomas. 2006. Water-saving irrigation for Mississippi rice production. 2006 Annual Report, Mississippi State University.

Powers, Shane. 2005. Water use and irrigation energy cost analysis in the Mississippi Delta. YMD Joint Water Management District. Stoneville, MS.

Powers, Shane. 2006. Water use and irrigation energy cost analysis in the Mississippi Delta. YMD Joint Water Management District. Stoneville, MS.

Smith, M. C., J. H. Massey, J. Branson, J. W. Epting, D. Pennington, P. L. Tacker, J. Thomas, E. D. Vories and C. Wilson. 2006. Water use estimates for various rice production systems in Mississippi and Arkansas. Irrigation Science. Accepted for publication.

USDA-NASS. 2004. Farm and Ranch Irrigation Survey (2003), Volume 3, Special Studies. Washington, D.C.

USDA-NRCS. 1997. National Engineering Handbook, Part 652, Irrigation Guide. Washington, D.C. pp 2-18, 2-23, 3-6, 5-7

USDA-SCS. 1960. Louisiana Irrigation Guide. Alexandria, LA. Chapter 2, pp 9-12.

USDA SCS. 1988. Soil Survey of Concordia Parish, Louisiana.

AGRICULTURE

Irrigation Water Conservation Through Use of Level Basins in Louisiana

Branch and Daniels

U.S. Department of Commerce (1996). Farm and Ranch Irrigation Survey (1994). Washington, D.C.

USGS. 1998. Estimated use of water in the United States in 1995. USGS Circular 1200, Denver, CO.

USGS. 2004. Estimated use of water in the United States in 2000. USGS Circular 1268, Denver, CO.

Vories, E. D., P. L. Tacker and R. Hogan. 2005. Multiple inlet approach to reduce water requirements for rice production. *Applied Engineering in Agriculture*, 21(4): 611-616.

AGRICULTURE





SEDIMENTATION



Sediment Monitoring of Mill Creek, Rankin County, Mississippi

Michael S. Runner
USGS Mississippi Water Science Center

Pre-settlement sediment accumulation rates in lake-wetland systems in the Mississippi Delta region using the ^{14}C activity of bulk sediment fractions

Greg R. Davidson, William G. Walker, Todd Lange and Daniel Wren
Geology and Geological Engineering, University of Mississippi

Effects of Sitation on Some Aquatic Animals Communities in a Man-made Lake in Ilorin, Nigeria

Chioma G. Nzeh and I. Bello
Department of Zoology, University of Ilorin-Nigeria

Experimental Design Analysis Applied to Factors Related to Migration of Sediment Out of a Stormwater Catchbasin Sump

Humberto Avila and Robert Pitt
Department of Civil, Construction, and Environmental Engineering, The University of Alabama

SEDIMENTATION

Sediment Monitoring of Mill Creek, Rankin County, Mississippi

Michael S. Runner
USGS Mississippi Water Science Center
308 South Airport Road
Jackson, MS 39208
601-933-2941
E-mail: msrunner@usgs.gov

ABSTRACT

Mill Creek in Rankin County, Mississippi, drains an 11 square mile watershed and flows into Pelahatchie Bay of the Ross Barnett Reservoir. Higher than expected sediment yields from Mill Creek have required that dredging operations in the affected areas be completed on 3-year intervals rather than the 10-year intervals which were planned when the reservoir was constructed.

A study of sediment yields during four storms in 1998 indicated that some areas of the watershed had significantly higher yields than other areas of similar size. In 2006, the U.S. Geological Survey, in cooperation with the Rankin County Board of Supervisors, began collecting streamflow and sediment concentration data at three locations in the watershed. The data are being collected to monitor the effects of structural improvements installed by Rankin County to reduce the volume of sediment flowing from Mill Creek into Pelahatchie Bay. Two locations were sampled as part of the 1998 study, allowing a comparison of the discharge-sediment concentration relation for the two time periods. The third sampling location will provide information on the sediment concentrations in the runoff from a primarily undeveloped area.

Keywords: sediment, runoff, streamflow

Introduction

The U.S. Geological Survey (USGS), in cooperation with the Rankin County Board of Supervisors (Rankin County), has developed and is implementing a monitoring program to collect streamflow and suspended-sediment data at selected locations in the Mill Creek Watershed in Rankin County, Mississippi. Data currently are being collected at four locations in the watershed. Two of the monitoring locations were selected, in part, based on results from a 1998 study (Runner, 1998) that indicated some areas of the watershed had significantly higher sediment yields than other areas of similar or larger size.

Data are being collected in support of the County's efforts to reduce the amount of sediment that is flowing from

the Mill Creek Watershed into Pelahatchie Bay of the Ross Barnett Reservoir (fig. 1). Results of the monitoring program will be used to assist in the selection of the location and type of sediment reduction efforts that will be implemented in the watershed. The data will also be used to evaluate the effects of the work after it has been completed.

Higher than expected sediment yields from Mill Creek require more frequent (3-year intervals rather than the 10-year intervals) dredging activities in Pelahatchie Bay than were originally planned. The dredging is necessary to maintain the viability of that part of the Bay as a recreational water body for boaters and fishermen. The increased dredging activity also diverts financial resources that might have been used in other areas of the Reservoir.

SEDIMENTATION

Purpose and Scope

This report describes the current (spring 2007) status of the monitoring effort, describes planned additions to the monitoring program, and presents results of data collection and preliminary analysis thus far.

The Mill Creek Watershed is located in Rankin County, Mississippi, and flows into Pelahatchie Bay of the Ross Barnett Reservoir (fig.1). The watershed is approximately 11.1 square miles and is a mixture of forest, residential, commercial, and agricultural land use. Data collection began in August 2006 and will continue through September 2008.

Data currently (2007) are being collected at four locations (fig. 2) in the watershed: Mill Creek at Highway 25 (USGS station number 02485574), Mill Creek Tributary No.

1 at Grants Ferry Road (USGS station number 02485577), Mill Creek at Castlewoods Boulevard (USGS station number 02485573), and Mill Creek Tributary No. 5 at Woodlands Drive (USGS station number 0248557250). Data collection consists of the operation of continuous stream-discharge stations and the collection of suspended-sediment data during runoff events.

In addition to the continuous monitoring stations, discrete streamflow- and sediment-data will be collected during runoff events at additional locations, one on Mill Creek and several on small tributaries (fig. 2). A summary of the existing, historic, and proposed monitoring locations and their basin characteristics is shown in table 1.



Figure 1. Location of Mill Creek watershed in Rankin County, Mississippi.



Figure 2. Location of current, historical, and proposed monitoring sites in the Mill Creek Watershed in Rankin County, Mississippi.

Table 1. Monitoring locations in the Mill Creek Watershed in Rankin County, Mississippi [DA, drainage area; mi², square miles; L, stream length; mi, miles; S, channel slope from 10 to 85 percent of length; Percent is percent of total drainage area].

Fig. 2 map no.	Monitoring location and site name	DA (mi ²)	L (mi)	S (ft/ml)	Percent	Remarks
1	Mill Creek at Spillway Rd.	11.1	6.65	15.3	100.0	Sampled in 1998
2	Mill Creek Trib. #1	1.03	1.51	34.5	9.3	Sampled in 1998
3	Mill Creek Trib #1 at Grants Ferry Rd.	0.94	1.20	41.1	8.5	Current real-time site
4	Mill Creek Trib. #1 Site B	0.23	0.45	59.3	2.1	Proposed synoptic sampling site
5	Mill Creek Trib. #2 Site A	0.34	0.99	82.2	3.1	Proposed synoptic sampling site
6	Mill Creek Trib. #2 Site B	0.30	0.76	124.6	2.7	Proposed synoptic sampling site
7	Mill Creek at Hwy 25	8.92	5.63	17.1	80.5	Sampled in 1998, Current real-time site
8	Mill Creek Trib. #3 sampling site	0.98	1.54	36.4	8.8	Proposed synoptic sampling site
9	Mill Creek Trib. #4 Site A	0.62	1.21	43.0	5.6	Proposed synoptic sampling site
10	Mill Creek Trib. #4 Site B	0.26	0.65	65.6	2.3	Proposed synoptic sampling site
11	Mill Creek at Castlewoods Blvd.	6.37	4.65	18.6	57.5	Current real-time site
12	Mill Creek Trib. #5 sampling site	0.21	0.70	68.6	1.9	Current real-time site
13	Mill Creek at Golf Course	5.32	3.82	20.6	48.0	Proposed synoptic sampling site
14	Mill Creek at Coon Hunters Rd.	1.92	2.09	36.9	17	Sampled in 1998

Data Collection

Stream Discharge

Stream discharge data are computed by using measured water-level, or stage, and a stage-discharge relation. Stage data are collected at the continuous monitoring stations by using a non-submersible pressure transducer to measure the water level, and a data-collection platform to record the data. Data are measured and recorded every 15 minutes and transmitted via satellite to the USGS office in Jackson, MS.

Streamflow measurements over the range of stage are made to develop a relation between stage and discharge.

The resulting relation is used to compute the instantaneous discharge at the monitoring location.

Suspended Sediment Concentration

Water samples at the monitoring stations are collected by the USGS during site visits, and by automatic pumping samplers during runoff events. The USGS collects depth- and width-integrated water samples using methods and equipment described in USGS technical publications (Guy and Norman, 1970; Wilde, 1998). Automatic samplers installed at the continuous monitoring locations are activated when the stage exceeds a preset threshold. After activation, the

SEDIMENTATION

sampler collects a water sample at a preset time interval. The threshold and sampling interval is unique to each site and is based on the range in stage and duration of the hydrographs. The water samples are sent to the USGS sediment laboratory in Baton Rouge, La., for analysis to determine the concentration of sediment in the water. The concentrations for the integrated samples are compared to the results of the samples collected by the pumping samplers to determine correction coefficients that are applied to adjust the pumped samples to better represent the average concentration in the stream.

Suspended Sediment Discharge

Sediment discharge is the product of the concentration and the stream discharge. It represents the rate at which the sediment is passing a specific transect of the stream and is generally expressed in units of tons per day (t/d):

$$Q_{s_n} = C_n * Q_n * 0.0027 \quad (1)$$

where:

Q_{s_n} = Instantaneous sediment discharge, in tons per day;

C_n = Instantaneous sediment concentration, in milligrams per liter;

Q_n = Instantaneous stream discharge, in cubic feet per second;

0.0027 = Unit conversion factor.

Sediment load is the sum of the sediment discharges weighted by time. It represents the total volume of sediment passing a specific transect of the stream and generally is expressed in units of tons (t).

Sediment yield is the total sediment load at a particular transect divided by the drainage area above that point on the stream. It represents the average volume of sediment that is generated from a unit area of the drainage basin. Sediment yield generally is expressed in units of tons per square mile (t/mi²).

Land Use

In January 2006, Rankin County purchased high-resolution photography for the Mill Creek Watershed. This photography was analyzed using USGS software to delineate and classify land-use in the watershed. This software creates data sets compatible with popular graphical information system (GIS) software which was then used to determine the percentage of the watersheds and sub-watersheds in the various land-use categories. A summary of the land use data obtained from the 2006 photography is included in table 2.

Data Results

To date, more than 400 water samples have been collected at the continuing monitoring stations, and laboratory results for samples collected through the end of October 2006 have been received. A summary of the October samples is presented in table 3.

On October 16 and 17, 2006, the Mill Creek Watershed received approximately 2.1 inches of rain in a 24-hour period. Sediment loads for this event for both Mill Creek at Highway 25 and Mill Creek Tributary No. 1 were computed using GCLAS (Graphical Constituent Loading Application Software). Figures 3 and 4 show the streamflow- and sediment- concentration hydrographs for the two monitoring locations. A summary of the data collected for each station is listed in table 4. For the two days of the event, 207 tons of sediment flowed from Mill Creek at Highway 25, and 180 tons moved from Mill Creek Tributary No. 1. These loads represent sediment yields of 23.2 and 191 tons per square mile respectively (table 4).

The data also indicate Mill Creek Tributary No.1 experienced a small rise on October 18, 2006, where the sediment concentration was greater than 2,000 mg/L for a substantial part of the day (fig. 4). The computed sediment load on Mill Creek Tributary No. 1 for October 18 was 11 tons, with a daily mean streamflow and sediment concentration of 2.3 ft³/s and 1,020 mg/L, respectively.

Suspended sediment loads computed from the October 2006 sediment samples were compared to results from a

Table 2. Land-use categories and percent of watershed of land-use data for locations in the Mill Creek Watershed. [DA, drainage area]						
Monitoring location and site name	DA (mi ²)	Forest	Urban	Barren	Open Water	Range-grassland
Mill Creek at Spillway Rd.	11.1	58	19	9	2	12
Mill Creek Trib. #1	1.03	22	15	57	1	5
Mill Creek Trib #1 at Grants Ferry Rd.	0.94	24	7	62	1	5
Mill Creek Trib. #1 Site B	0.23	0	12	88	0	0
Mill Creek Trib. #2 Site A	0.34	90	8	1	1	0
Mill Creek Trib. #2 Site B	0.30	96	1	2	1	0
Mill Creek at Hwy 25	8.92	62	18	3	2	15
Mill Creek Trib. #3 sampling site	0.98	53	20	2	2	23
Mill Creek Trib. #4 Site A	0.62	66	14	10	0	10
Mill Creek Trib. #4 Site B	0.26	73	1	21	0	5
Mill Creek at Castlewoods Blvd.	6.37	64	15	3	2	16
Mill Creek Trib. #5 sampling site	0.21	4	95	0	0	1
Mill Creek at Golf Course	5.32	70	4	4	3	19
Mill Creek at Coon Hunters Rd.	1.92					

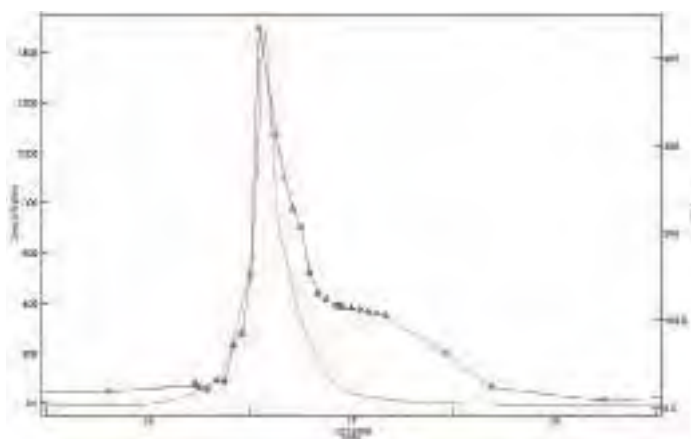

Figure 3. GCLAS plot showing discharge- and sediment-concentration hydrographs for Mill Creek at Highway 25, October 16 - 18, 2006.

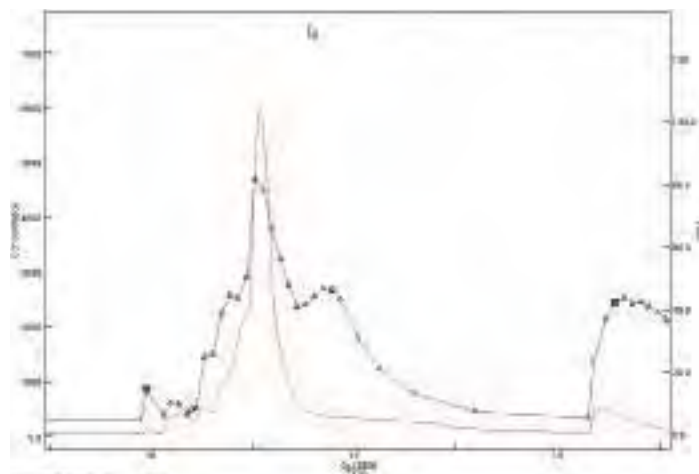

Figure 4. GCLAS plot showing discharge- and sediment-concentration hydrographs for Mill Creek Tributary #1 at Grants Ferry Rd., October 16 - 18, 2006.

SEDIMENTATION

1998 sediment study (Runner, 1998) for the same locations. During the 1998 study, samples were collected at the Highway 25 monitoring location and on Tributary #1 at a bridge downstream from the current monitoring location.

A preliminary review of the data suggests that, for Mill Creek at Highway 25, the stream discharge-sediment load relation is about the same in 2006 as it was in 1998 (fig. 5). The data for Mill Creek Tributary #1 at Grants Ferry Road indicate that for a given streamflow, there is more sediment in transport now than there was in 1998 (fig. 6).

Summary

In response to higher than expected sediment deposition from Mill Creek in Rankin County into Pelahatchie Bay of the Ross Barnett Reservoir, the Rankin County Board of Supervisors initiated an effort to reduce erosion in the Mill Creek watershed and the subsequent transport of the eroded material into Pelahatchie Bay. To support Rankin County's efforts, the U.S. Geological Survey is collecting streamflow and sediment concentration data at locations in the Mill Creek watershed. Data have been collected at two monitoring locations

Table 3. Results of sampling at Mill Creek monitoring stations in October 2006 [ft³/s, cubic feet per second; mg/L, milligrams per liter; t/d, tons per day; Min., minimum; Max., maximum].

Monitoring station	Number of Samples	Sampled stream discharge (ft ³ /s)		Suspended-sediment concentration (mg/L)		Suspended-sediment discharge (t/d)	
		Min.	Max.	Min.	Max.	Min.	Max.
Mill Creek at Highway 25	85	5.7	250	47	1040	1.8	668
Mill Creek Trib. No 1 at Grants Ferry Road	95	<1	96	324	6460	1.1	1140

Table 4. Summary of streamflow and suspended sediment concentration data collected at Mill Creek at Highway 25 and Mill Creek Tributary No. 1 at Grants Ferry Rd., October 16 and 17, 2006 [ft³/s, cubic feet per second; mg/L, milligrams per liter].

Monitoring station	Maximum streamflow (ft ³ /s)	Maximum concentration (mg/L)	Daily-mean streamflow Oct. 16/17 (ft ³ /s)	Daily-mean concentration Oct. 16/17 (mg/L)	Sediment load (tons)	Sediment yield (tons/mi ²)
Mill Creek at Highway 25	432	1040 @ 238 ft ³ /s	18 / 74	79 / 513	207	23.2
Mill Creek Trib. No 1 at Grants Ferry Road	104	4590 @ 88 ft ³ /s	12 / 15	890 / 1970	180	191

SEDIMENTATION

Sediment Monitoring of Mill Creek, Rankin County, Mississippi Runner

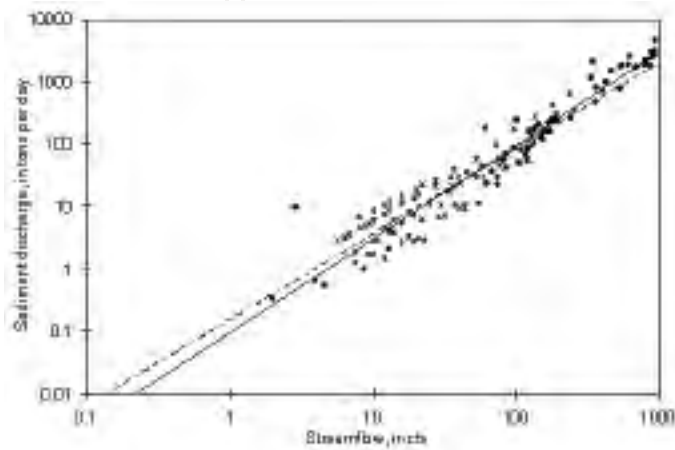

Figure 5. Comparison of the streamflow - suspended-sediment-discharge relation for data collected at Mill Creek at Highway 25 in 1998 and 2006.

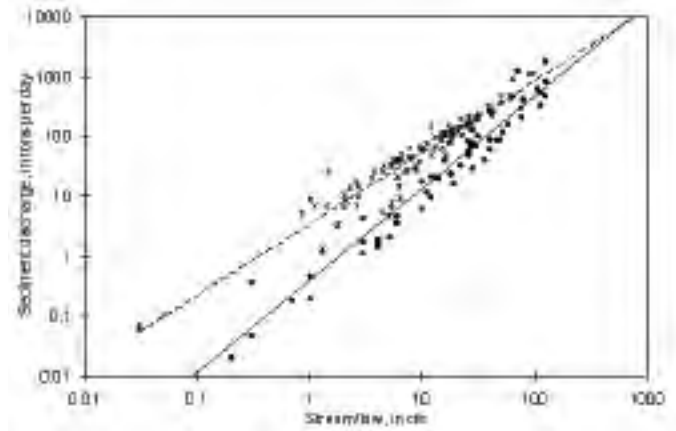

Figure 6. Comparison of the streamflow - suspended-sediment-discharge relation for data collected at Mill Creek Tributary No. 1 in 1998 and 2006.

since October 2006 and additional monitoring is planned for the future. Data will be used to compute sediment loads in Mill Creek and some of its tributaries, determine areas of the watershed that contribute more sediment than others, thus making them candidates for structural improvements, and monitor the effectiveness of the structural improvements and best management practices that are implemented in the watershed.

Preliminary results from data collected during October 2006 have been compared to data collected in 1998. These data suggest that the sediment yields in some areas of the watershed are higher now than they were at the time of the earlier study.

References

- Runner, M.S., 1998, Mill Creek basin sediment study, Rankin County, Mississippi, January-March 1998, U.S. Geological Survey Open-File Report 99-275, 22 p .
- Guy, H.P., and Norman, V.W., 1970, Field methods for measurement of fluvial sediment: U.S. Geological Survey Techniques of Water-Resources Investigations, book 3, chapter C2, 59 p.
- Wilde, F.D., and others, 1998, National field manual for the collection of water-quality data: U.S. Geological Survey Techniques of Water-Resources Investigations; book 9, variously paginated.

SEDIMENTATION

Pre-settlement sediment accumulation rates in lake-wetland systems in the Mississippi Delta region using the ^{14}C activity of bulk sediment fractions

Gregg R. Davidson, William G. Walker, Todd Lange, Daniel Wren
Geology & Geological Engineering
University of Mississippi
Carrier 118
University, MS 38677
662-915-6995
E-mail: wgwalker@olemiss.edu

ABSTRACT

Sediment accumulation rates in lakes and wetlands are known to increase when neighboring land is converted to agricultural use, but the magnitude of historical changes is often difficult to assess. In most areas, few records exist on the natural rate before large-scale changes in land use began. This is particularly true in areas such as the heavily cultivated Delta region of Mississippi where most of the land was cleared more than a century ago. Standard methods such as ^{137}Cs and ^{210}Pb dating techniques are useful for establishing modern sediment accumulation rates in these areas, but not for establishing rates prior to settlement.

Carbon-14 has often been used in lake studies to determine the age of specific layers or to determine ancient sedimentation rates, but methods generally rely on isolating recognizable plant fragments or fossils that are often difficult to find. Where macrofossils are absent, pollen may be dated, but extraction of pollen is labor intensive and requires use of toxic chemicals. Bulk sediment fractions are not generally preferred because they contain an unknown mixture of organic material of variable age, they may contain dead carbon such as lignite that is difficult to eliminate, and material of aquatic origin may be subject to reservoir effects that add apparent age. If the various processes that contribute carbon to the system are relatively constant over time, however, changes in ^{14}C activity with depth may be used to accurately estimate sediment accumulation rates even if the absolute age are erroneous.

In this study, fine-grained fractions (250-710 μm organic material, humic acid extract from $<250\ \mu\text{m}$ size fraction, and untreated $<250\ \mu\text{m}$ size fraction combusted at low temperature) were analyzed and compared with terrestrial plant stems (twigs), charcoal and wood fragments in sediments from Sky Lake in Humphreys County, Mississippi. The ^{14}C activities of the bulk fractions were highly linear with depth, and produced consistent calculated sediment accumulation rates similar to, and perhaps more reliable than rates determined using twigs or charcoal.

Keywords: Sediments, Wetlands, Hydrology, Methods

SEDIMENTATION

Effects of siltation on some aquatic animals communities in a man-made lake in Ilorin, Nigeria

Chioma G. Nzeh and I. Bello
Department of Zoology
University of Ilorin
Nigeria
234-803-7261108
E-mail: cgnzeh@yahoo.com

ABSTRACT

The effects of siltation on aquatic animals communities in a man-made lake in Ilorin, Nigeria were investigated. Samples of the sediments were collected using Ekman's grab. The sediments were sieved through various mesh sizes until fine silt were obtained. The silt were air-dried to a constant weight in the laboratory and measurement of the final weight of the silt were taken. Macro-invertebrates were collected using scoop nets and identified. The fishes were collected using cast and gill nets. The water temperature, pH, dissolved oxygen content and transparency were measured. Results indicate that the surface water temperature ranged from 23 to 27°C. Dissolved oxygen content of the lake varied from 3.6 to 4.4 mg O₂/l. The water transparency fluctuated between 88.75cm to 153cm while the silt content of the lake was 11.27% to 24.6%. The invertebrates collected were gastropods and bivalves. The fishes in the lake were family Cichlidae which was the most abundant, other families were Bagridae and Anabantidae. Silt was gradually being deposited in the lake and the volume of water in the lake was gradually being reduced especially during the dry season when there is little or no rainfall. Some portions of the lake dried up during the dry season due to accumulation of silt and the invertebrates living in the affected area of the lake were exposed to desiccation resulting in decrease in population of invertebrates. This fresh water lake is gradually being degraded and factors such as construction of residential houses around the lake and agricultural practices were identified as the major causes of siltation of the lake.

Keywords: Siltation, Degradation and freshwater

Introduction

Silt is part of the soil with a diameter of 0.02 to 0.05mm and it contains silicate mineral. The pore space between silt particles are smaller than sand. Silt has the ability to retain water and nutrients between particles for plant use. Silt is the ideal soil for growing crop.

(Bogg 1995). Clay is less than 0.002mm in diameter. The pore is too small therefore clay is sticky. Sand is above 0.05mm and less than 2.00mm in diameter. Sandy soil is limited in nutrient because the large pore spaces between sand grains allow nutrients to leach out. Silt is transported into lakes via water which is an effective means of moving

earth mineral. This occurs over time as the speed of the water transporting the material changes. Sedimentation of lakes is higher than marine environment. This is because Lakes are smaller and are nearly closed systems. Silt is deposited in deeper water areas of the lake.

Some researchers have investigated the effects of moving earth's materials into water bodies. Gliwicz (1989) showed that suspended clay in the lake water may be an important factor limiting primary production by decreasing availability of light and nutrient. Lind and Davalos-Lind (1999) showed that clay competes with plankton for ions such as phosphorus. Owen and Lind (2003) demonstrated that suspended

SEDIMENTATION

clay competes with autotrophs for nutrients and it is the principal cause of light attenuation in many waters. Thus it governs plankton, benthic and macrophyte production. There is little or no work reported on siltation in Agba lake, the objective of this research is to investigate the effects of siltation on aquatic animal communities in a man-made (Agba) lake in Ilorin, Nigeria.

Study Site

Agba lake is located in Ilorin, Kwara state, Nigeria (fig. 1) it was constructed by damming Agba river. It lies between latitude $8^{\circ}30'N$ and longitude $4^{\circ}35'E$. The lake was commissioned in 1956. The depth measured between 14 to 17 meters. The lake has a storage capacity of 50 million liters during rainy season and 30 million liters during the dry season. The lake was constructed primarily to supply water for domestic and industrial usage in Ilorin township.

Materials and Methods

Collection of sediment

Ekman's grab was used to collect sediment from the bottom of the lake. The sediment was sieved through various mesh sizes of sieves. The sediment that was retained in the sieve measuring 0.02 to 0.05 mm in diameter was collected as silt. The sediment was air dried and weighed. Sampling was carried out in a stratified random manner from various sections of the lake.

Physical Condition of the lake

The physical condition measured in the lake was surface water temperature and transparency. The surface water temperature was measured using mercury in glass thermometer. The thermometer was lowered to a depth of about 15 mm and the temperature was recorded.

Transparency was measured using a secchi disc the diameter was 20.20 cm. The disc was lowered into the lake until the first point of disappearance.



Figure 1. Agba Lake, Ilorin, Nigeria.

Dissolved Oxygen

The dissolved oxygen content of the water was measured by titrimetric method and the pH values of the lake were determined using pH meter.

Sampling of Macroinvertebrates

A qualitative sampling of macroinvertebrates was carried out using scoop nets. The content of the scoop net were sorted out and identified.

Table 1. Monthly mean variation in Temperature transparency dissolved oxygen pH and silt content of Agba Lake Ilorin, Nigeria.

Parameter	Jan	Feb	March	April	May	June	July	Aug	Sept
Temperature (°C)	26.7	26.5	27.0	27.2	26.6	24.0	24.8	24.4	25.0
Transparency (cm)	120.0	121.2	124.0	120.2	107.0	89.1	130.3	112.0	117.8
Dissolved O ₂ (mg/l)	4.95	4.0	4.84	4.70	4.50	4.55	4.20	4.0	4.05
pH	6.86	6.90	6.85	7.0	6.78	6.91	7.17	7.4	7.38
Silt (%)	22.47	25.50	26.83	27.10	27.6	20.4	15.8	15.2	19.5

Sampling of the fishes

The fishes were sampled using cast net and gill nets and they were identified to species

Results

The surface water temperature in Agba lake varied from 23°C to 27°C. The water transparency range observed in the lake was 89.10cm to 130cm mean values (Table 1). The pH fluctuated from 6.9 to 7.4. The dissolved oxygen content of the water approximately 4.0mg/L to 5.0mg/L (Table 1).

The silt content of the lake was about 15% to 28% as shown in table 1. The lowest values of silt were obtained during the month of August while the highest values were obtained in April and May.

The macroinvertebrates collected from the lake were mollusca and the two classes represented were gastropoda and bivalvia. The gastropods were *Biomphalaria* and *Lymnae*. *Lymnae* were more abundant constituting about 80% of the invertebrates. While *Biomphalaria* formed about 15%. The bivalvia represented by *Asphatharia* species constituted about 5% of the invertebrates.

The fisheries composition of the lake showed that four families were represented: Cichlidae, bagridae, claridae and anabantidae. The family cichlidae represented by *Hemichromis fasciatus*, *Tilapia zillii*, *Sarotherodon galilaeus* and *Oreochromis niloticus* (Table 2) were the most abundant species and they formed about 85% of the catch. The bagri-

dae represented *Auchenoglanis occidentalis* and *chrysichthys nigrodigitatus* formed 10% while claridae represented by *Clarias anguillaris* and anabantidae represented by *Ctepo-ma kinsleye* constituted about 2.5% of the catch respectively.

Discussion

The transparency values obtained in this present work indicate that enough light penetrate the water for photosynthetic activities by the autotrophic plankton in the lake. Kemdirim (1990) obtained higher values for a man-made lake in Jos Plateau State, Nigeria. The presence of suspended matter may be responsible for the scattering of solar radiation in Agba Lake resulting in low Sechi disc transparency value. The temperature and pH values observed in this present work were within tolerable range for aquatic organisms (Boyd 1978). The oxygen content of Agba lake was within the range recommended for aquatic organisms (Boyd 1978).

Silt is gradually being deposited in the lake with a portion of the lake drying up (Plate 1) during the months of January to April representing the period of little or no rainfall in Ilorin. The implication is that the gastropods: *Biomphalaria*, *lymnae* and Bivalve represented by *Asphatharia* are exposed to dessication resulting in decrease in the population of the invertebrates. Similar observation was made by Kreutzweiser et. al. (2005), their results showed a decline in the aquatic insect communities as a result of fine sediment inputs.

In Agba lake, the major factor identified to be responsible for the deposition of silt in the lake is construction (Plate

SEDIMENTATION

Table 2. Macroinvertebrates and fish species composition of Agba Lake, Ilorin, Nigeria.

Phylum	Genus	Relative Abundance %
Mollusca	<i>Biomphalaria sp</i>	15
	<i>Lymnae</i>	80
	<i>Asphatharia</i>	5
Fishes		
Family	Species	%
Cichidae	<i>Hemichromis fasciatus</i>	15
	<i>Tilapia zillii</i>	20
	<i>Sarotherodon galilaeus</i>	35
	<i>Oreochromis niloticus</i>	15
Total		85
Baridae	<i>Audenoglanis occidentalis</i>	5
	<i>Chrsichthys nigrodigitatus</i>	5
Total		10
Claridae	<i>Clarias anuillaris</i>	2.5
Anabantidae	<i>Ctenopoma kinsleye</i>	2.5
Total		5

2). When the total ground surface is stripped of vegetation, the upper soils are vulnerable to water erosion. Plate 3 shows a house construction around the river source. This has been identified as a major source of silt into Agba Lake. This observation is in line with the findings of Water (1995), Wood and Armitage (1997), Fossati et. al. (2001), they identified catchment disturbance which could be as a result of agricultural tillage, urbanization, and construction as leading to deposition of sediment in stream bed.

Agba Lake was commissioned in 1956 the town plan-

ning authority should have acquired the land around the Lake so that the environment and the lake will be preserved. However the land was left in the hands of the land owners who sold out their pieces of land and the buyers were constructing houses around the lake. During the rainy season water washes the silt in the soil into the lake thereby filling some portions or areas of the Lake with silt. The deposition of silt in the lake will continue every rainy season into the lake and this has adverse effect on the biodiversity of the lake.

There is a decline in the richness of animal diversity of the lake. The populations of *Biomphalaria*, *Lymnae* and *Asphatharia* have decreased. The fishes in the lake are also affected because the dominant species are the Cichlids. The nest of the guarders are built in the soil where the eggs are deposited during reproduction but where siltation have occurred in the shallow region this may affect the number of eggs that will survive and grow into adult fishes. If siltation continues unchecked in Agba Lake gradually there will be great reduction in the volume of water in the lake and a decrease in the population of aquatic animal communities in the lake. Eventually there will be a change in the structure of the lake making it impossible to serve the function of provision of water for the human community in Ilorin township and there will be loss of the aquatic animal communities in the lake.

References

- Boggs, S., (1995) Principles of sedimentology and stratigraphy, Prentice hall, Englewood Cliffs. N.J.
- Boyd, C.E., (1979) Water quality in warm water fish ponds craftsman printers, Inc. Auburn Alabama, 353pp.
- Fossati O., Wasson J., Hery C., Salinas G. and Marin R. (2001). Impact of sediment releases on water chemistry and macroinvertebrate communities in clear Water Andean streams (Bolivia). Arch Hydrobiologia 151:33-50.
- Gliwicz, M.Z. (1989) suspended clay concentration by filter - feeding zooplankton in A tropical reservoir Nature 323: 330-332.

Kemdirim, E. C (1990) Periodicity succession of phytoplankton in an upland and lowland impoundments in plateau state (Nigeria) in relations to Nutrients Levels and physical characteristics J. Aquatic Sciences 5: 43 -52.

Kreutweiser, D.P. Capell, S.S and Good, K.P. (2005) Effects of fine sediment inputs from a logging road on stream insect communities: A large-scale experimental Approach on a Canadian headwater stream Aquatic Ecol. 39: 55-66.

Lind, O.L. and Davalos-Lind, L. (1999) suspended clay: its role in Reservoir productivity in: Theoretical Reservoir Ecology and its Applications 83-97 Ed. J.G. Tundisi and M.S Traskraba Brazilian Academy of Sciences Publishers.

Owen, O. and Lind, W. (2003) Suspended Clay's effect on lake and reservoir limnology Arch. Hydrobiol. Suppl. 139/3, Stud., p. 327-360.

Waters, T.F. (1995) Sediment in streams, biological effects and control. American fisheries society, Bethesda U.S.A.

Wood, P.J and Armitage, P.D (1997) biological effects of the sediment in the environment. Environmental Manag. 21:P 203-217.

SEDIMENTATION

Experimental design analysis applied to factors related to migration of sediment out of a stormwater catchbasin sump

Humberto Avila and Robert Pitt

Ph.D. Candidate, Department of Civil, Construction, and Environmental Engineering

The University of Alabama

P.O. Box 870205

Tuscaloosa, AL 35487

205-348-2895

E-mail: hfavilarangel@bama.ua.edu

Abstract

The sediment-capture performance in conventional catchbasin sumps has been reported to be in the wide range between 14 and 99% (USEPA, Metcalf & Eddy 1977); obviously, the higher performance is obtained by combining low flowrates, large particle sizes, and high specific gravities. Typically, up to about 30% of the total stormwater particulates are captured during actual rainfall tests (Pitt 1985). The accumulation rate, or sediment-retaining performance, depends on the size and geometry of the device, the flow rate, sediment size, and specific gravity of the sediment. In the same way, scour phenomenon includes all those parameters previously mentioned, in addition to the water protection layer and the consolidation of the sediment bed due to aging.

In order to evaluate the importance of the parameters and their interactions on the phenomenon of scour of sediment out of a conventional inlet catchbasin, a modeling experiment was designed (2^4 full-factorial) and performed examining four parameters (flow rate, sediment size, water protection depth, and specific gravity). Each factor was evaluated at 2 levels: flow rates at 1.6 L/s and 20.8 L/s, sediment diameters at 50 μm and 500 μm , water protection depths at 0.2 m and 1.0 m over the sediment, and sediment specific gravities at 1.5 and 2.5. A 2-dimensional Computational Fluid Dynamic (CFD) model was implemented in Fluent 6.2, using the Eulerian multiphase model. The evaluation consisted of determining the reduction of sediment mass from the chamber over time. When examining the loss of sediment after 1,000 sec of continuous flow (17 min), the results showed that the expected important parameters of flow rate, sediment size, and water protection depth, were statistically significant when explaining sediment scour. The water protection depth over the sediment is related to the extent of exposure of the sediment layer to the in-flowing water. However, it was also found that specific gravity of the sediment was not an important factor affecting sediment scour.

Key Words: Sediment, Models, Methods, Nonpoint Source Pollution.

Introduction

The sediment-capture performance in conventional catchbasin sumps has been reported to be in the wide range between 14 and 99% (Metcalf & Eddy 1977); obviously, the higher performance is obtained by combining low flowrates, large particle sizes, and high specific gravities. Typically, about 30% of the total stormwater particulates are captured in properly designed catchbasin sumps during actual rainfall tests (Pitt 1985). The accumulation rate of sediment in a

catchbasin sump depends on the size and geometry of the device, the flow rate, sediment size, and specific gravity of the sediment. In the similar way, scour phenomenon likely includes all these parameters, in addition to the depth of the water protection layer above the sediment and the consolidation of the sediment bed due to aging.

A series of tests was conducted to evaluate the importance of the parameters and their interactions on the phenomenon of sediment scour out of a conventional catchbasin

Experimental design analysis applied to factors related to migration of sediment out of a stormwater catchbasin sump

Avila and Pitt

sump located at a stormwater inlet. A 2-dimensional computational fluid dynamics model (CFD), using Fluent 6.2, was used to conduct a full 2^4 factorial experiment that examined four parameters: flow rate, sediment size, overlying water protection depth, and specific gravity of the sediment.

Flow rate, sediment size, and the depth of water over the sediment, were the significant main factors that explained sediment scour. However, specific gravity of the sediment material was not as important as these other factors.

These scour observations are similar to what has been observed during field tests of catchbasins in the past. The next stage of this research program is directly measure the 3-D velocity fields in the laboratory using a full-sized catchbasin with a sump to confirm these calculations. The last research phase will include selected controlled scour tests for further confirmation. Finally, the results will be implemented in the WinSLAMM stormwater model to better consider sediment scour from small hydrodynamic devices.

Geometry of the Computational Model

The geometry of the manhole was the same as the optimal manhole geometry recommended by Larger, et al. (1977), and tested by Pitt (1979; 1985; and 1993). For this geometry, if the outlet diameter is D , the total height of the manhole is $6.5D$ and the inside diameter is $4D$; the outlet has to be located $4D$ above the bottom and $2.5D$ below the top of the manhole. The outlet diameter (D) was selected as 300

mm (12 inches) for these experiments. A 2-dimensional model (2D) was implemented in Fluent 6.2 by using the longitudinal center-line cross section on the predominant flow direction (see Figure 1).

Experimental Design for Four Factors

A 2^4 -full factorial experimental design (without replicates) (Box, et al. 1978) was used to determine the significance of four factors (flow rate, sediment particle size, water depth, and specific gravity), and their interactions, on the scour of previously captured sediment from a catchbasin sump. The model used a continuous flow of a submersible-water jet (the impact geometry was previously determined after detailed evaluations of the cascading water from the inlet flows) during a 3,600 sec (1 hr) period of time. There were obvious changes in the flow field and resulting shear stress values with time, so model results from several time periods were examined. Table 1 shows the factors with their corresponding low and high values that were used during the different experiments.

A multiphase Eulerian model was implemented for the 2^4 -full factorial experimental design, with which it is possible to consider two phases: water, and a dense sediment bed. Because the multiphase Eulerian model is a mixture model and does not allow an immiscible water-air interphase, the flow was assumed to be a vertical-submersed water jet. The conditions of the inflow jet were previously determined by

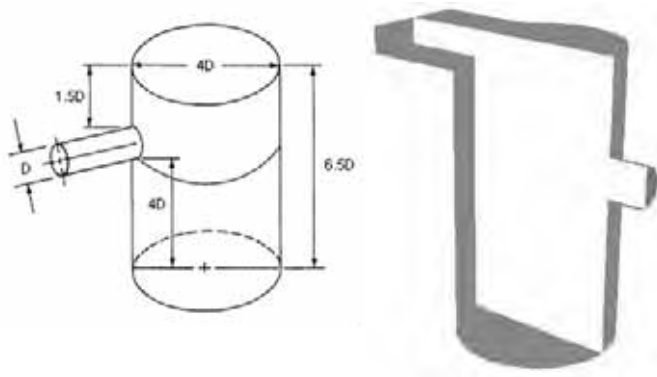

Figure 1. Typical catchbasin geometry by Larger, et al. (1977) (left) - 2D longitudinal center-line cross section (right).

	Factor	Low Values	High Values
A	Flow rate (L/s)	1.6	20.8
B	Particle size (μm)	50	500
C	Water depth (m)	0.2	1.0
D	Specific gravity	1.5	2.5

SEDIMENTATION

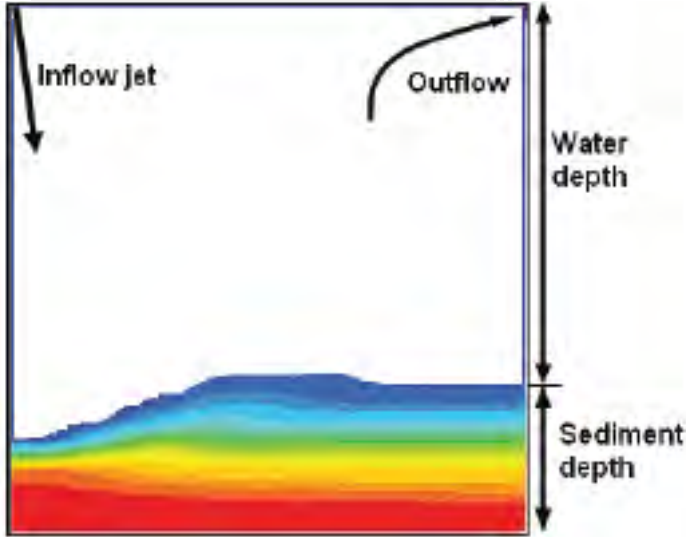

Figure 2. Inflow, and outflow directions, water and sediment depth of the 2D model implemented for the 2⁴-full factorial experimental design.

CFD modeling of the cascading water from a circular and from a rectangular inlet. Figure 2 shows the location of the inlet, outlet, the water depth, and the sediment depth.

Results of the 2⁴-Full Factorial Experimental Design

After simulating all 16 treatments for the 3,600 sec durations, the reduction of sediment depth (sediment loss) was plotted as a function of time. The sediment depth is the complement of the water protection depth; if the water depth is 0.2 m, the sediment depth is 1.0 m.

Figure 3 shows the changes in the sediment depth with time, making it possible to see the effects of the factors and their interactions. As expected, high flows with shallow water depths (AC) result in the fastest washout of the sediment, followed by high flows alone (A). Particle size alone (B) and particle size and specific gravity combined (BD) had little effect on scour.

The significance of the factors and their interactions were examined at six different times: 60, 300, 600, 1,000, 1,800, and 3,000 sec. Each analysis included the determination of the effects of the factors, the normal probability plot of the effects, the ANOVA (with no replicates), and the evaluation

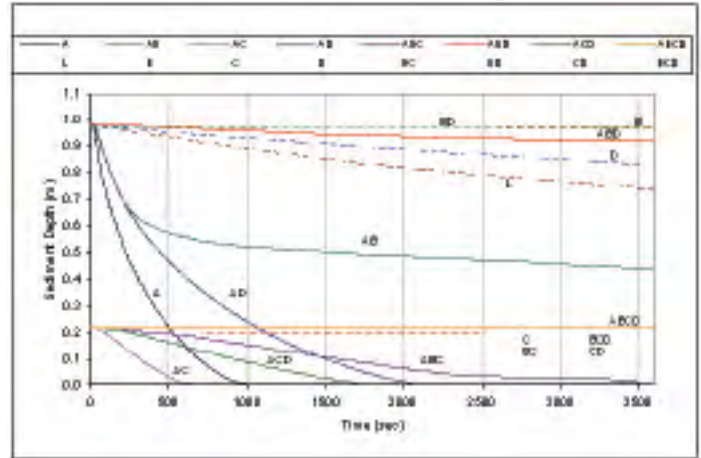

Figure 3. Reduction of Sediment Depth as a function of Time for each treatment. Results of the 2⁴-full factorial experiment (A: flow rate; B: particle size; C: water depth; and D: specific gravity).

of resulting residuals.

The coefficients of the effects for all the evaluated times show that flow rate (A), water depth (C), particle size (B), and the interaction of flow rate and water depth (AC) are the most significant factors in the calculated scour (Figure 4). In contrast, specific gravity (D) is located at the sixth or eighth position, which indicates that specific gravity is not as relevant as the other main factors and several of the 2-way interaction terms.

Similar results were obtained when the factors and interactions were examined using normal probability plots (Figure 5); flow rate (A), particle size (B), and water depth (C) were found to be significant, along with flow rate-water depth (AC) interactions for all time steps and flow rate-particle size (AB) interactions for half of the time steps. As noted above, specific gravity (D) was not identified as a significant factor, either alone, or in any of the significant interaction terms. In order to further validate these results using a more quantitative criterion, an ANOVA analysis was applied to detect the significant factors and interactions at the 95%, or better, confidence level.

SEDIMENTATION

Experimental design analysis applied to factors related to migration of sediment out of a stormwater catchbasin sump

Avila and Pitt

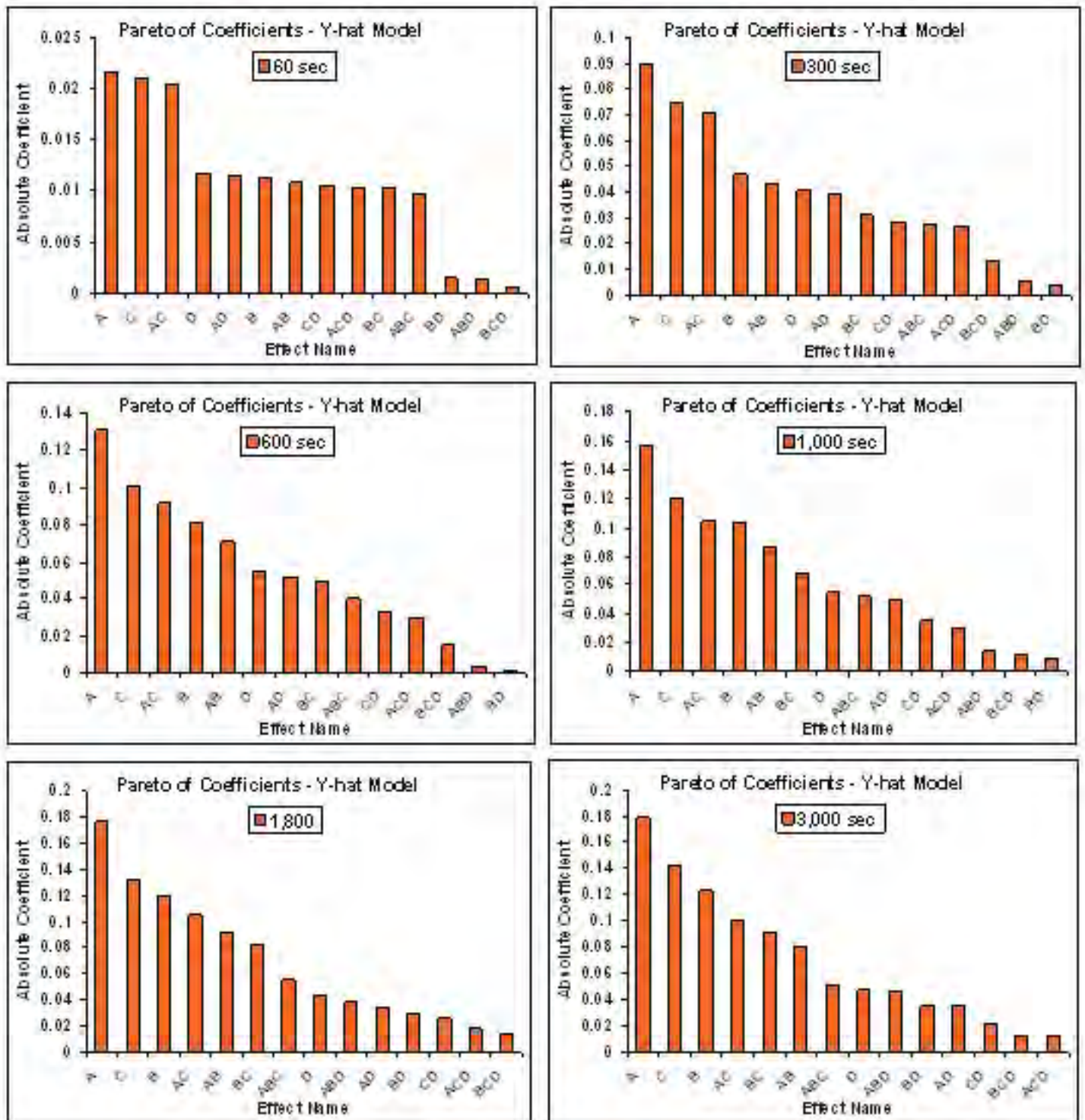

Figure 4. Coefficients of effects for each treatment at times 60, 300, 600, 1,000, 1,800, and 3,000 sec (A: flow rate; B: particle size; C: water depth; and D: specific gravity).

SEDIMENTATION

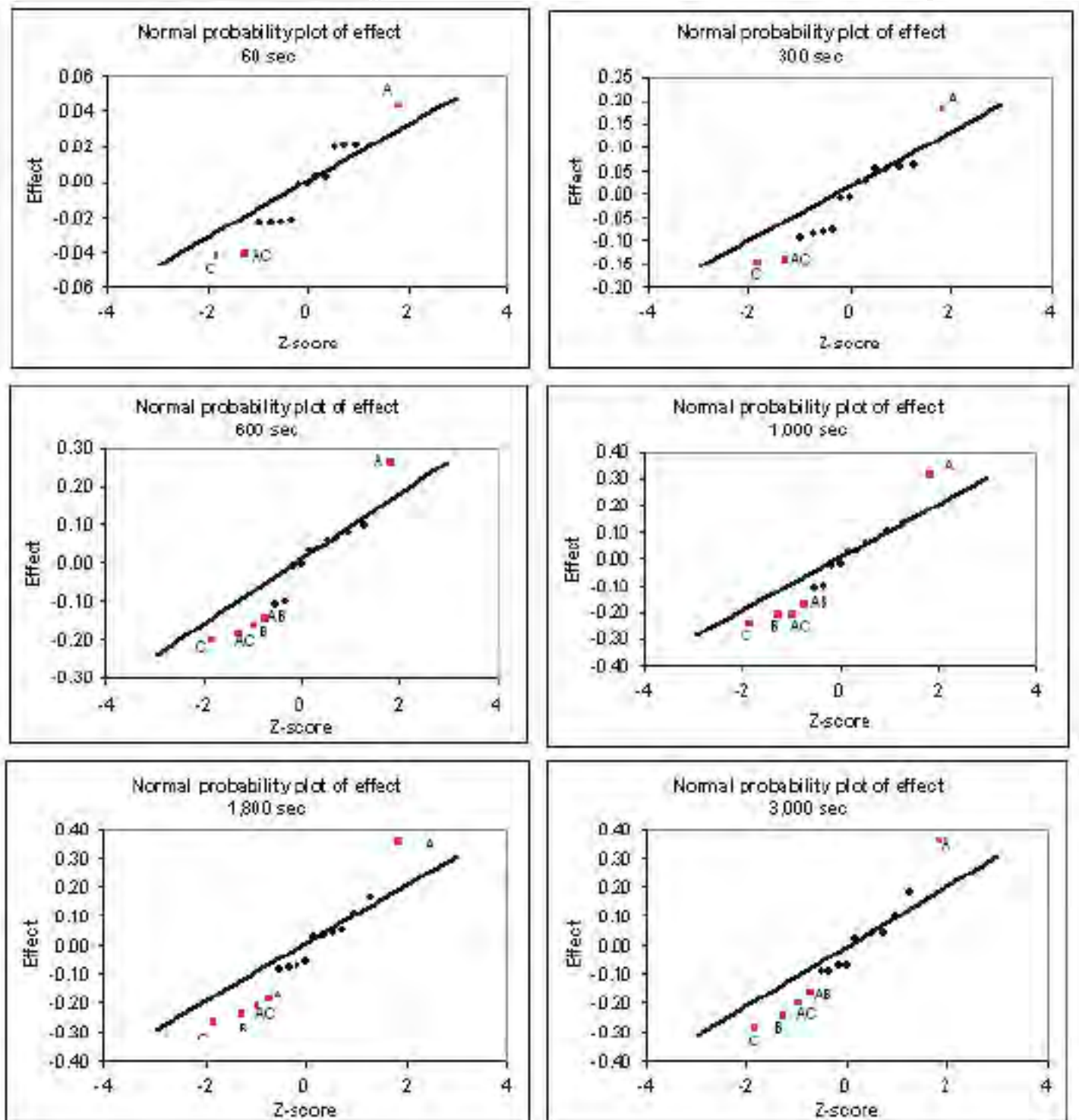

Figure 5. Normal probability plot of the effect estimated for times 60, 300, 600, 1,000, 1,800, and 3,000 sec (A: flow rate; B: particle size; C: water depth; and D: specific gravity).

SEDIMENTATION

Experimental design analysis applied to factors related to migration of sediment out of a stormwater catchbasin sump

Avila and Pitt

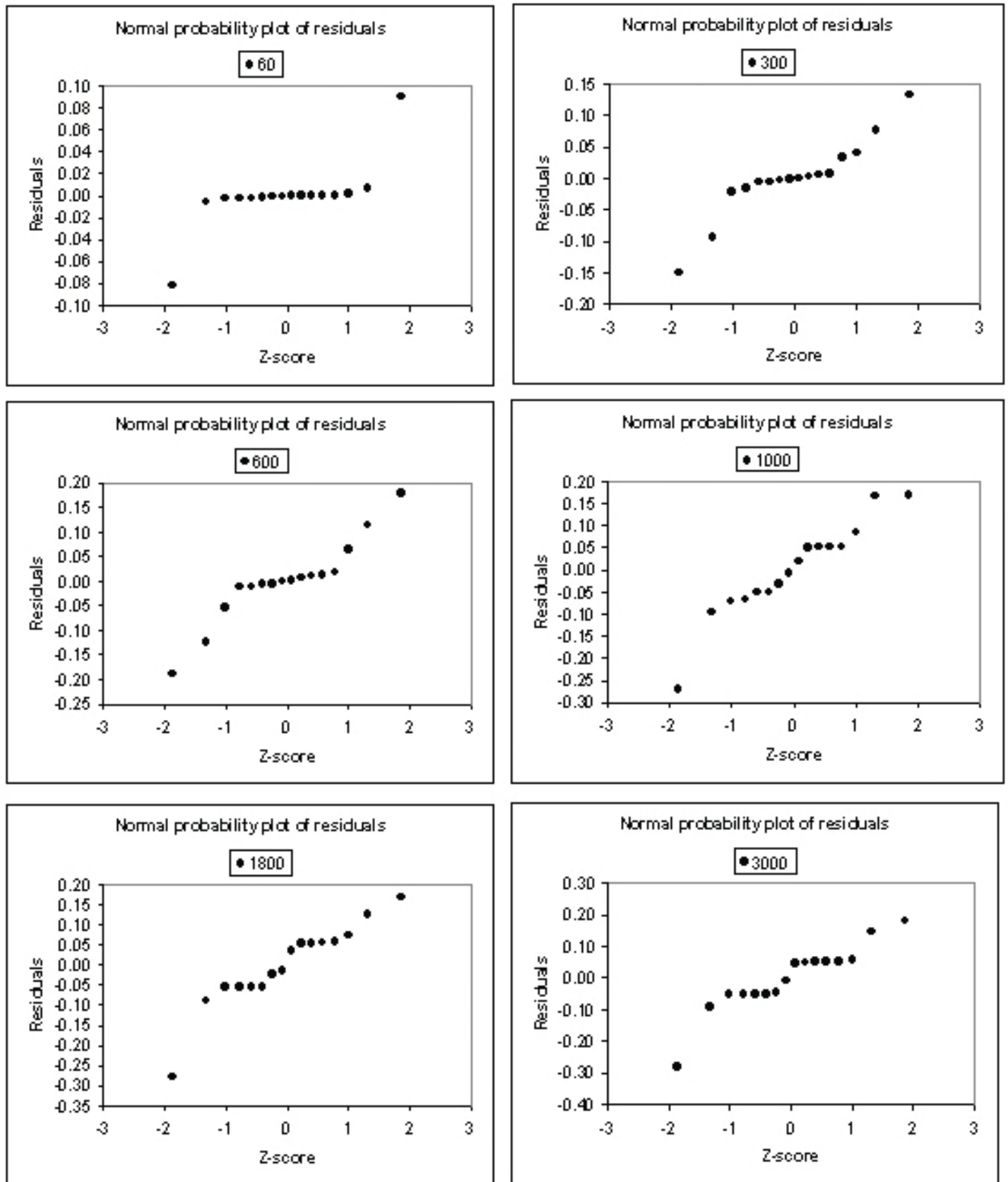

Figure 6. Normal probability plot of residuals estimated for times 60, 300, 600, 1,000, 1,800, and 3,000 sec.

SEDIMENTATION

Table 2. ANOVA results: p-values for each treatment at different times of the simulation.

Treatment	Time (sec)					
	60	300	600	1000	1800	3000
A	0.02	0.006	0.003	0.003	0.003	0.003
B	0.14	0.06	0.02	0.02	0.01	0.01
C	0.02	0.01	0.009	0.009	0.01	0.008
D	0.13	0.09	0.08	0.12	0.24	0.22
AB	0.15	0.08	0.03	0.03	0.04	0.06
AC	0.02	0.01	0.01	0.01	0.02	0.03
AD	0.13	0.10	0.09	0.15	0.34	0.34
BC	0.17	0.17	0.10	0.07	0.05	0.04
BD	0.82	0.86	0.97	0.77	0.41	0.34
CD	0.16	0.21	0.24	0.28	0.47	0.54

An ANOVA with no replicates was used to determine the p-values for each factor and interaction (Table 2). A confidence level of 95%, or better, would have a p-value of 0.05, or smaller, and these are indicated with values in bold typefaces. These results are the same as the previous evaluations; they show that flow rate, particle size, and water depth are significant factors for times greater than 600 sec (10 min). Additionally, the interactions of flow rate-particle size, flow rate-water depth, and particle size-water depth were also significant. However, specific gravity, or any interaction containing specific gravity, was not significant at the 95% confidence level for any of the evaluated times.

Additionally, residuals were calculated to determine normality and independency. Figure 6 shows that the residuals appear normal for times greater than 1,000 sec (17 min). However, shorter times show lack of normality. On the other hand, considering that there are only several data points, it is not possible to have a clear impression of homoscedastic or heteroscedastic patterns. However, homoscedastic behavior of the residuals was typically achieved for times greater than 1,000 sec.

As expected, flow rate and particle size were identified as significant factors. Moreover, the water depth was also found to be a significant factor that protects the sediment layer from being scoured. However, specific gravity (for the range observed) was not identified as a significant factor.

Conclusions

Flow rate, particle size, water depth, and their interactions, are significant factors that affect the scour of sediment in a conventional catchbasin sump. Specific gravity is not as important as these other factors over time under continuous flow conditions in terms of loss of sediment mass out of a conventional catchbasin sump.

The overlying water layer depth above the sediment has an important function in protecting the sediment layer from scour. High shear stresses caused by the impacting water jet will not easily reach the sediment surface if the water is deep. However, once the flow is stabilized, the developed velocity field will reach the sediment surface at all depths, so the important shear stress may be best representative in this condition. Moreover, with deeper water, the resulting shear stress conditions on the sediment surface are less than for shallower water, for all modeled conditions.

Consolidation of the deposited sediment bed and cohesive properties of clay were not included in these analyses. These are relevant factors that suggest a greater permissible shear stress of the sediment bed before scour, and therefore require further analysis.

References

Box, G.E.P., W.G. Hunter, and J.S. Hunter (1978). *Statistics for Experimenters*. John Wiley and Sons. New York.

Cheng N., Chiew Y., (1999) "Analysis of Initiation of Sediment Suspension from Bed Load," *Journal of Hydraulic Eng.* Vol 125, No. 8, pp 855-861, August, 1999.

Faram, M.; Harwood, R.; Deahl, P., "Investigation into the Sediment Removal and Retention Capabilities of Stormwater

SEDIMENTATION

Experimental design analysis applied to factors related to migration of sediment out of a stormwater catchbasin sump

Avila and Pitt

Treatment Chambers," StormCon Conference, Texas, USA, July 2003

FLUENT 6.2. Computational Fluid Dynamic (CFD) Software. User's Manual. <http://www.fluent.com/>

Garde, R., Ranga Raju K., (1977) Mechanics of Sediment Transportation and Alluvial Stream Problems, Edition John Wiley & Sons, New Delhi, pp 45-68.

Lager, J.A., W.G. Smith, W.G. Lynard, R.M. Finn, and E.J. Finnemore. (1977), "Urban Stormwater Management and Technology: Update and Users' Guide. U.S. EPA-600/8-77-014", Cincinnati, Ohio, September 1977.

Pitt, R. (1979) Demonstration of Nonpoint Pollution Abatement Through Improved Street Cleaning Practices, EPA-600/2-79-161, U.S. Environmental Protection Agency, Cincinnati, Ohio. 270 pgs.

Pitt, R. (1985), "Characterizing and Controlling Urban Runoff through Street and Sewerage Cleaning," U.S.EPA/2-85/038. PB 85-186500/AS. Cincinnati, June 1985

Pitt, R. and U. Khambhammettu. (2006), "Field Verification Tests of the UpFlow™ Filter. Small Business Innovative Research, Phase 2 (SBIR2)" U.S. EPA, Edison, NJ. 275 pages. March 2006.

U.S. Environmental Protection Agency (1977), "Catchbasin Technology Overview and Assessment," EPA-600/2-77-051. Authors: Lager J., Smith W., Tchobanoglous G., Metcalf & Eddy, Inc. OHIO, 1977.



WASTEWATER & WATER TREATMENT

Water Quality Impacts of Failing Septic Systems in a Coastal Area

Mary Love M. Tagert, Quinton White, James Martin and Jonathan Pote
Mississippi Water Resources Research Institute, Mississippi State University

Occurrence and Persistence of Pesticides, Pharmaceutical Compounds, and other Organic Contaminants in a Conventional Drinking-Water Treatment Plant

Richard H. Coupe and D.P. Bach
US Geological Survey, Water Science Center

Standardization of Thermal Desorption GC/MS Analysis for Polycyclic Aromatic Hydrocarbons and Comparison of Recoveries for Two Different Sample Matrices

Jejal Reddy Bathi, Robert Pitt, and Robert Findlay
Civil, Construction and Environmental Engineering, University of Alabama

Phytomanaging Firing Range Soils Using *Cyperus esculentus*

Afrachanna D. Butler, Maria F. Begonia and Victor Medina
US Army Engineer Research and Development Center

WASTEWATER AND WATER TREATMENT

Water Quality Impacts of Failing Septic Systems in a Coastal Area

Mary Love M. Tagert, Quinton White, James Martin and Jonathan Pote
MS Water Resources Research Institute
Mississippi State University
Box 9680
Mississippi State, MS 39762
662.325.8081
E-mail: mltagert@cfr.msstate.edu

ABSTRACT

A study is underway to determine the water quality impacts of failing onsite wastewater systems (OWS) on the St. John's River and its tributaries near Jacksonville, Florida. The four main objectives of the study are as follows: 1) review previous Total Maximum Daily Load (TMDL) studies and other studies related to failing OWS in the study area, 2) compile and review data on permits issued for OWS, 3) incorporate geospatial technologies to help develop a water quality sampling plan and analyze potential trends, and 4) implement an intensive sampling plan to analyze samples at 3 baseline sites and approximately 8-14 potentially impacted sites for total Kjeldahl nitrogen (TKN) and phosphorous. Field measurements for temperature, salinity, and dissolved oxygen are also being taken at each sampling site. Efforts are being made to capture both dry and wet weather samples monthly at each site from September 2006 through February 2007, or for the duration of the project. Sample collection and analysis has begun, although a lack of rainfall has limited sampling to date. Collection of ground truth information and water samples has been initiated. Sampling results will be evaluated as data becomes available throughout the initial six-month project and will be included in this presentation. An analysis of the data will determine if the project should be extended for an additional six months or more.

Keywords: water quality, surface water, wastewater

WASTEWATER AND WATER TREATMENT

Occurrence and Persistence of Pesticides, Pharmaceutical Compounds, and other Organic Contaminants in a Conventional Drinking-Water Treatment Plant

Richard H. Coupe and D.P. Bach
US Geological Survey, Water Science Center
308 S. Airport Rd.
Jackson, MS 39208
601-933-2982
E-mail: rhcoupe@usgs.gov

ABSTRACT

In late August and early September 2006, the U.S. Geological Survey, with assistance from the City of Jackson, collected three sets of water samples from the Ross Barnett Reservoir and O.B. Curtis drinking-water treatment plant. Each set included a sample of (1) the source water from the reservoir; (2) effluent from the settling process (but before dual media filtration and chlorination); (3) and the finished water. Each sample was analyzed for over 100 compounds including pesticides and pesticide degradates, pharmaceutical compounds and other organic contaminants that are indicative of wastewaters. Four herbicides (atrazine, metolachlor, hexazinone, and floridone) and 2 pesticide degradates (deethyl-atrazine and desulfinyl fipronil), and caffeine and cotinine (a nicotine degradate) were detected in low concentrations in 1 or more source water samples. These compounds were detected in the settled and finished water in roughly the same concentrations as detected in the source water. The concentrations were all below 0.5 µg/L, which is several orders of magnitude below acute toxicity levels as determined by the U.S. Environmental Protection Agency for pesticides and pesticide degradates. Atrazine and metolachlor are used for the protection of crops in the production of food and fiber, but also are used in urban areas to control weeds in lawns, parks, and other recreational areas. Hexazinone is used in silviculture, and floridone is used in the upper parts of the Ross Barnett Reservoir to control aquatic vegetation. Caffeine and cotinine are likely derived from sewage-treatment-plant effluent discharged into streams that supply the Ross Barnett Reservoir. Most compounds were not detected in any samples, and a few compounds were present in the source water but not in finished water; thus, indicating that these compounds are either degraded or removed by treatment processes used at this facility.

Keywords: water supply, agriculture, toxic substances, water quality, wastewater

Standardization of Thermal Desorption GC/MS Analysis for Polycyclic Aromatic Hydrocarbons and Comparison of Recoveries for Two Different Sample Matrices

Jejal Reddy Bathi, Robert Pitt, Robert Findlay
Civil, Construction and Environmental Engineering
University of Alabama
Box: 870205, 260 H.M.Comer Hall
Tuscaloosa, Alabama 3548
205-3482895
E-mail: jejalb@gmail.com

ABSTRACT

The analysis of PAHs in environmental samples involves sampling, extraction, concentration and final analysis using GC-MS. Traditional extraction of PAHs from a solid matrix, where much of the PAH reside, is a tedious and time consuming process. Thermal desorption (TD) can replace the traditional sample preparation step in the analysis scheme with a more efficient and direct method, which also eliminates the organic solvents used in the traditional extraction procedures, with the added advantage of significantly reducing the sample preparation time. This paper examines the recovery of standard PAHs solutions spiked on glass wool for different desorption times using TD techniques. Recoveries for desorption times ranging from 1 min to 20 min were studied. The peak areas obtained for individual PAHs increased as desorption time increased from 1 min to 15 min, while there was a decrease in peak areas as desorption times increased to 20 min. Therefore, the optimum desorption time for the highest recovery of PAHs was found to be 15 min. Coefficients of variation were calculated using the optimized desorption time for the PAH mix spiked on the glass wool substrate. It was found that low molecular weight and high molecular weight PAHs have high coefficients of variation (naphthalene 49%, Fluorene 24.2%, Dibenz(ah)anthracene 14.8%, Benz(ghi)perylene 15.5%), while the intermediate PAHs had much lower coefficients of variation (ranging from 0.5% - 4.0%). The method response was tested for linearity by analyzing the glass wool spiked with five different concentrations of PAH mixtures, ranging from 0.01 to 20ng/ μ L.

The second part of the research examined the PAH recoveries from glass wool compared to Tenax spiked with PAH mixtures. This was performed by spiking the wool and 10 mg of tenax with 20ng/ μ L of the PAH mixture. The recovery of low molecular weight PAHs (having fewer numbers of rings) was larger in the case of Tenax than for the glass wool, whereas for the high molecular weight PAHs (having more rings), the recovery of PAHs from glass wool was larger than from the Tenax matrix.

Keywords: Toxic substances, Water quality, Methods, Sediments

Introduction

Environmental contamination of natural resources with persistent organic pollutants (POP) is of great concern. Polycyclic aromatic hydrocarbons (PAHs) are an example of persistent organic pollutants of concern. As an example, some of the PAHs have been determined to be carcinogenic by several regulatory agencies (US Environmental Protection Agency (EPA), US Department of Health and Human Services (DHHS) and the International Agency for Research on

Cancer (IARC).

PAHs in urban runoff can occur in both particulate and soluble forms, although studies have identified the particulate forms as being the most predominate (Pitt et al. 1999). According to the Hwang and Foster (2005) study on urban stormwater runoff in Washington DC, particulate-associated PAHs account for 68-97% of total PAHs in the runoff.

The rapid and effective analyses of samples for toxicant contamination is very important to minimize their potential

WASTEWATER AND WATER TREATMENT

effects on the environment and on public health. The general analytical procedure for polycyclic aromatic hydrocarbons (PAHs) and other organic contaminants (such as pesticides) involves: sample collection, sample preparation and extraction, and final determination. In most cases, problematic PAH concentrations in water are typically low, emphasizing the extraction and concentration steps in the analytical process. Final detection of these contaminants is usually carried out with gas chromatography with a mass spectrophotometer detector.

Water or solid samples to be analyzed for PAHs contamination usually undergo solvent extraction prior to analysis. Liquid-liquid extraction by separatory funnel, or by continuous extraction, or by solid-phase extraction, are the most common extraction methods for liquid samples. Soxhlet, automated Soxhlet, and ultrasonic extraction methods are the common solvent extraction methods for PAHs from solid samples.

Solid-phase extraction (SPE) is the most common method used for the extraction and concentration of organic contaminants in liquid samples. EPA method 3535, under SW-846, explains the applicability, operation and limitations of the method. Organics from a known volume of liquid sample is extracted using a solid phase extraction device (a solid-phase sorption substrate in a filter stand) and then the targeted analytes are eluted from the solid-phase media using an appropriate solvent. However, suspended solids present in the sample can cause analytical and technical problems in sample concentration and final detection. Technical problems caused by suspended solids includes the plugging of the SPE cartridges and disks, which will cause the extraction to last for several hours, or even render it impossible, and difficulty in extracting the organics from the particulates, as SPE was developed to extract organics from filtered water samples. Continuous extraction of liquid samples for PAHs, as described in EPA method 3520, is more efficient (based on recovery) for samples containing particulates up to 1% (10,000 mg/L) that can cause emulsions. However, this method requires expensive glassware, uses fairly large volumes of solvents, and requires extraction times of 6 to 24 hours.

EPA method 3540 describes the Soxhlet procedure for

extraction of PAHs from solid matrices. As explained in EPA method 3540, a known amount of solid sample is mixed with anhydrous sodium sulfate and placed into an extraction thimble, or between two plugs of glass wool, and continuously extracted using an appropriate solvent. The extraction method may provide efficient extraction, but it requires about 16 to 24 hours for single samples and uses fairly large volumes of solvent. EPA method 3550, described under SW-848, outlines the detailed procedure of ultrasonic energy for extraction of semivolatile organic compounds from solid matrices. This method is comparatively efficient, requiring shorter times for extraction, but has less extraction efficiency. Ultrasonic extraction methods also use relatively large volumes of solvent, requires an expensive piece of equipment, and it requires large amounts of sample for samples having low concentrations of the analyte of interest.

Generally, PAHs are most effectively extracted from liquid samples at a neutral pH with methylene chloride. The commonly used solvents for extraction of PAHs from solid matrices are dichloromethane, cyclohexane, benzene, and methanol. Evaporation is usually employed to concentrate the solvents containing the extracted organics. The separation and detection methods are further described in EPA methods 8100 and 8310. These traditional approaches for extraction and evaporation are labor-intensive and time consuming. These methods are also prone to contamination introduced by impurities in the solvents, and also use large quantities of organic solvents in the process that could cause environmental contamination and hazards to the operators.

An alternative to the traditional approach of solvent extraction of organics in the presence of large amounts of particulates is thermal extraction. This method is becoming more popular and readily available, but has not been thoroughly tested. Thermal extraction, or thermal desorption, techniques use elevated temperatures as a means to transfer the analytes from solid sample matrices to the gaseous analytical system. The analytes desorbed from the solid sample matrices are concentrated in a cryotrap at the head of a GC column. The concentrated analytes are then separated and detected using a standard GC column and MS detector which is similar to the analysis of liquid samples when con-

Standardization of Thermal Desorption GC/MS Analysis for Polycyclic Aromatic Hydrocarbons and Comparison of Recoveries for Two Different Sample Matrices

Bathi, et al

centrated into a solvent. The research team at UA is continuing their work to develop an effective analysis procedure by incorporating thermal desorption techniques into effective analysis processes. The first part of this paper describes the general procedure employed in thermal desorption of PAHs. The second part of this paper provides the optimum operating conditions of the method followed by comparisons of the recoveries obtained for two different solid matrices. The two solid matrices used for study are glass wool and Tenax, and are spiked with a liquid standard mixer of PAHs.

Analysis Procedure

Tube Conditioning:

Prior to the use of the thermal desorption tubes for the analysis of samples, the thermal desorption tubes need to be conditioned at elevated temperatures. The conditioning of the tubes helps in removing all foreign materials which may cause sample cross contamination or memory peaks in the sample analysis. The tube conditioning is performed with the help of high purity nitrogen gas. Initially, the tubes are flow conditioned at room temperature for several minutes to get rid of oxygen from the interiors of the tubes. After initial purging of the tubes at room temperature, the tubes are heated up to 350 °C at a rate of 4 °/min while purging with nitrogen gas. The tubes are maintained at elevated temperatures of 350 °C for four hours. Throughout the conditioning process, the nitrogen flow is maintained at about 60 mL/min. At the end of the four hours at the elevated temperature, the tubes are removed from the conditioning oven and placed in the cooling rack at the rear of the oven and allowed to cool for 10 minutes. When the tubes are cooled, the tubes are immediately capped on both ends with the pre-conditioned steel caps. The same procedure is used for conditioning the needles.

Tube Packing:

The thermal desorption tubes are made of stainless steel and are 4 mm in internal diameter and 100 mm long and threaded at both ends. Conditioned tubes are packed with the sample to be analyzed. Both ends of the tubes are plugged with glass wool to hold the sample in place and to

reduce the loss of fine particulates into the analytical stream that would plug the needle and accelerate contamination of the MS.

Analysis:

The packed tubes, which are ready for analysis, are then loaded onto the system carousel. Once the analysis process is initiated with the help of the AutoDesorb™ software from the remote control system, the desorption tube is purged to remove oxygen, excess water, and volatile materials that are resident in the tube. The needle is then lowered into the GC inlet and the injection period starts, followed by purging. The injection time period is set based on the instrument response to allow the injection port pressures to equilibrate and the proper split flow to be reached before the injection time expires. At the end of the injection time, the heater blocks close around the desorption tube and the tube is heated at a rate specified in the method. Carrier gas transports the desorbed analytes into the inlet of the GC. The cryotrap then traps the analytes entering the GC inlet by condensing the organic gases and focus the analytes for their concentration. The cryotrap is then heated up ballistically to release the focused analytes instantaneously into the GC column, where the analytes are separated based on their volatility and are then detected by the MS, based on their charge to mass ratios.

Optimum Conditions:

Optimum conditions for thermal desorption were selected based on a series of experiments conducted to obtain good recovery of analytes from the solid samples and to have good separation of the analytical peaks. For this purpose, standard solid samples were prepared by spiking 10 µL of the 20 mg/L PAH mixed standard onto pre-treated glass wool. The thermal desorption unit was subjected to different desorption times and desorption temperatures. The final desorption temperatures were tested ranging from 250 °C to 375 °C. Final desorption temperatures of 350 °C produced higher peaks of individual PAHs. Similarly, different desorption times were tested to obtain maximum peak areas. A series of runs were made with different holding times for the final desorption temperature. The range of final temperature

WASTEWATER AND WATER TREATMENT

holding times tested ranged from 1 min to 20 min. It was found that the peak areas obtained for individual PAHs increased as the holding time increased from 1 min to 15 min, and then decreased as the holding time further increased to 20 min. Therefore, the optimum desorption time for the highest recovery of PAHs was found to be 15 min. For three replicate runs, the coefficients of variation (COV) showed that low molecular weight and high molecular weight PAHs have high variations (naphthalene 49%, Fluorene 24.2%, Dibenz(ah)anthracene 14.8%, Benz(ghi)perylene 15.5%), while the intermediate PAHs had much lower variations (COVs ranging from 0.5% - 4.0%).

Testing Method for Linearity:

The developed method was tested for linear responses for the different PAHs. For this purpose, solid matrices were prepared by spiking Tenax with 10, 50, 100, 200 and 400

ng of the PAH standard mix. Table 1 shows the regression index of determination (R^2) values obtained for selected PAHs, which are all reasonable for this method.

Comparison of Recoveries:

The second step of the research examined the PAH recoveries from glass wool compared to Tenax spiked with PAH mixtures. This was performed by spiking the wool and 10 mg of Tenax with 20 ng/ μ L of the PAH standard mixture. The recovery of low molecular weight PAHs (having fewer numbers of rings) was more in the case of Tenax than for the glass wool, whereas for the high molecular weight PAHs (having more rings), the recovery of PAHs from glass wool was greater than from the Tenax matrix. The comparative recovery calculations clearly showed that the recoveries of analytes vary depending on solid matrices. Tenax (an adsorbent resin) represents environmental solid sample more

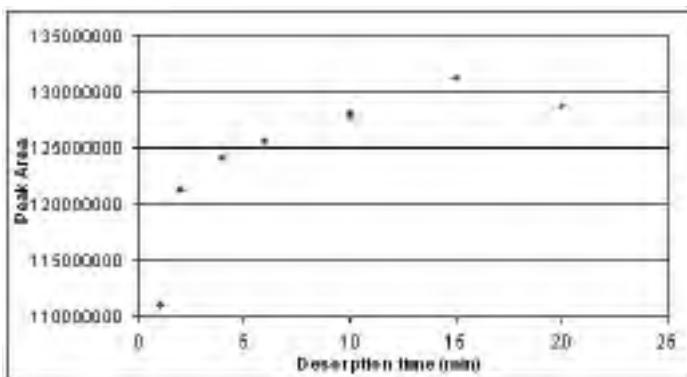

Figure 1. Desorption time versus peak areas for Pyrene

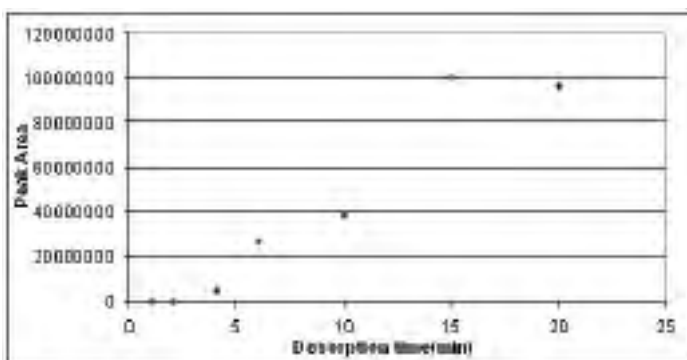

Figure 2. Desorption time versus peak areas for Benz(ghi)perylene

Optimal conditions of thermal desorption system:

Purge duration:	1.00 min
Injection duration:	1.00 min
Initial temperature:	50 °C
Temperature ramp rate:	100 °C
Final temperature:	350 °C
Final temperature holding time:	15 min
Cryo-trap:	enabled
Cryo cool temperature:	-40 °C
Cryo heat temperature:	300 °C
Cryo heat duration:	10.00 min
GC start time:	26.50 min

Standardization of Thermal Desorption GC/MS Analysis for Polycyclic Aromatic Hydrocarbons and Comparison of Recoveries for Two Different Sample Matrices

Bathi, et al

PAH	R ²
Naphthalene	0.9958
Fluorene	0.9848
Phenanthrene	0.9969
Anthracene	0.9944
Fluoranthene	0.9978
Pyrene	0.9975
Benz(a)anthracene	0.9934
Chrysene	0.9961
Benz(b)fluoranthrene	0.9925
Benz(a)pyrene	0.9881
Indeno (1,2,3-cd)pyrene	0.9819
Dibenzo (a,h)anthracene	0.9593
Benz(ghi)perylene	0.9657

closely then glass wool and hence the recoveries from Tenax matrix could give us a better idea about recovery of analytes from real environmental samples.

Analysis of a Standard Sample using Developed Method:

A marine sediment standard, NIST1941b obtained from the National Institute of Standards and Technology (NIST), was tested using the developed method. This standard sample was collected from Chesapeake Bay at the mouth of Baltimore (MD) Harbor near the Francis Scott Key Bridge using a Kynar-coated grab sampler. The standard is certified for 119 different constituents of PAHs, PCBs and chlorinated pesticides. The sample was ground and sieved so the sediment particles were finer than 150 μm.

A 10 mg portion of NIST1941 was subjected to the analysis with the operational conditions determined during the method development. Most of the analytes present in the standard sample were detected and clear individual peaks were shown. There were two major problems identified during the analysis of the standard material using thermal desorption GS/MS analysis, as discussed below.

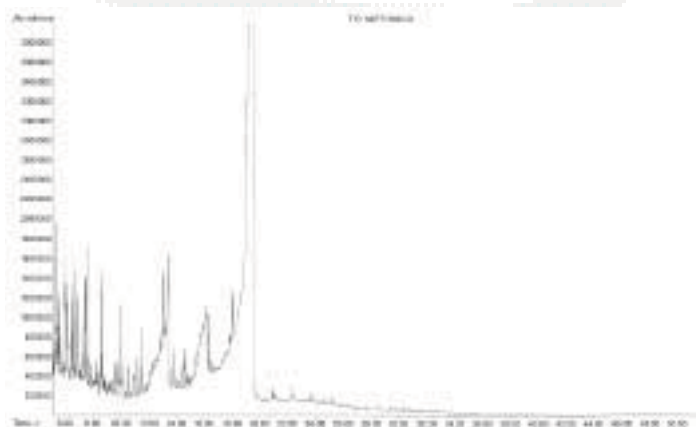

Figure 3. Chromatogram of NIST standard with dominant peaks of sulfur compounds

Presence of sulfur: Due to the presence of sulfur in the sediment sample, there were many unwanted sulfur-containing analyte peaks in the gas chromatogram. Sulfur products of PAHs bonds to particulate solids and makes them difficult to extract. As copper forms copper sulfide when reacted with sulfur, the addition of small amounts of copper into the thermal desorption tube along with the sediment sample helped in avoiding the sulfur products of PAHs. Figure 10 shows the chromatogram with unwanted peaks of sulfur products of PAHs.

Moisture in the sample:

Even after standard oven drying, the moisture content of the standard sample caused ice plugging in the GC column during the cryofocusing step and obstructed the flow of analytes through the column. This problem has caused tremendous reductions in the peak areas obtained for the individual analytes, and in some cases there were no peaks observed. To reduce the water content in the sample, samples were further freeze dried before analysis.

Recovery Calculations:

The percentage recovery of the developed method was tested by spiking environmental samples with 10 μL of the 20 ng/μL PAH standard mixture. An environmental runoff sample was collected from the University Mall parking lot in

WASTEWATER AND WATER TREATMENT



Figure 4. Chromatogram of NIST standard with ice plugging problem.



Figure 5. Chromatogram of freeze dried NIST standard with copper.

Tuscaloosa AL, and particulate matter in the water sample was separated by sieving the sample through a 90 µm sieve. The collected particulate matter was oven dried overnight at 100oC. Triplicate samples of dried particles of 10 mg each were subjected to TD-GC/MS analysis and resultant areas of the selected PAHs peak areas measured. Another triplicate sample of dried particles of 10 mg each were spiked with

the 10 µL of the 20 ng/µL PAH standard mixture and were subjected to TD-GC/MS analysis and the resultant peak areas measured and compared to the first batch results. The percentage recoveries of the spiked PAHs were calculated by comparing the differences in average peak areas obtained from the spiked and un-spiked environmental samples with average peak areas obtained by analyzing triplicates of the

Table 2. Comparison of peak areas for two solid matrices.

PAH	Mean area		Ratio of area
	Glass wool	10 mg Tenax	Glass wood/Tenax
Naphthalene	22788021.50	61202757.00	0.37
Fluorene	63267375.50	71902289.33	0.88
Phenanthrene	93644340.75	98973950.67	0.95
Anthracene	97919751.75	99626677.33	0.98
Fluoranthene	114127323.50	116877318.33	0.98
Pyrene	112801392.50	113481063.00	0.99
Benz(a)anthracene	125345520.00	122965363.00	1.02
Chrysene	127764095.00	127548616.00	1.00
Benz(b)fluoranthrene	137369218.50	137484565.00	1.00
Benz(a)pyrene	129740976.50	115008191.67	1.13
Ideno(1,2,3-cd)pyrene	128386541.00	90639700.67	1.42
Dibenz(a,h)anthracene	77365639.00	47015167.33	1.65
Benz(ghi)perylene	83206184.00	50522238.00	1.65

Standardization of Thermal Desorption GC/MS Analysis for Polycyclic Aromatic Hydrocarbons and Comparison of Recoveries for Two Different Sample Matrices

Bathi, et al

Table 3. Spike recovery of developed method.

PAH	Mean area			
	Environmental Sample	Liquid Standard (1000 µg/L)	Spiked Sample	% Recovery
Naphthalene	76379564	44635222	90154097	31
Phenanthrene	29615669	40529498	58078570	70
Anthracene	15669946	43013765	40612935	58
Fluoranthene	69663919	62594052	96248625	43
Pyrene	82927225	68914168	109785364	39
Benz(a)anthracene	53005722	54253782	70200141	32
Chrysene	98286258	56073172	116817543	33
Benz(b)fluoranthrene	114019177	69394215	142837284	42
Benz(a)pyrene	125545124	54748760	152641922	50
Ideno(1,2,3-cd)pyrene	92514576	68144887	119386641	39
Dibenz(a,h)anthracene	89867981	63016083	117948321	45

Table 4. Acceptable recoveries for selected analytes

PAH	¹ Acceptable range of % recovery from EPA methods (aqueous samples)	² Acceptable range of % recovery from <i>Standard Methods</i> (aqueous samples)
Naphthalene	*D - 122	21 - 133
Fluorene	D - 142	59 - 121
Phenanthrene	D - 155	54 - 120
Fluoranthene	14 - 123	26 - 137
Pyrene	D - 140	52 - 115
Benz(a)anthracene	33 - 143	33 - 143
Chrysene	17 - 168	17 - 168
Benz(b)fluoranthrene	24 - 159	24 - 159
Benz(a)pyrene	17 - 163	17 - 163

*DA: detected, result must be greater than zero

¹acceptable range of recoveries for EPA method 610 for analysis of organic chemicals from municipal and industrial wastewater, as provided under 40 CFR part 136.1.

²acceptable range of recoveries for extraction of liquid sample as provided in the standard methods for the examination of water and wastewater (2005)>

WASTEWATER AND WATER TREATMENT

20 ng/ μ L of liquid PAHs standard.

The calculated recoveries ranged from 30 to 70 percent, as shown on Table 3. Table 4 shows the acceptable range of extraction recoveries for PAHs from liquid samples using SPE methods. In general, one would expect higher percentages of recovery of analytes from liquid samples compared to solid samples. Even though calculated recoveries for some of the analytes have low percentage values, they are still in the acceptable ranges of listed recoveries.

Conclusions:

The suspended solids portion of PAH contamination is very important and needs to be considered when analyzing environmental samples. The traditional methods for liquid samples for PAHs analyses may not be effective when large portions of the PAHs are associated with particulates. Traditional methods for sediment analyses of PAHs are labor intensive, time consuming, and also involves large amounts of solvents which may cause environmental contamination. The newly developed thermal desorption technique for sample preparation is very effective for analyzing particulate-bound PAHs. This sensitive method is also suitable for analyzing particulates that have been separated from water samples by standard filtration. This research is also examining particulate-bound PAHs for many separate particulate sizes, separated by fine filters and sieves. The method showed good linearity over a wide range of analyte concentrations and the calculated recoveries of the method are within acceptable ranges. The method requires less preparation time and effort and produces final analysis results in much shorter periods of time. The new technique also doesn't involve the use of any solvents. However, this technique doesn't restrict unwanted analytes from entering the capillary column and the final detector. This additional material hastens the contamination of the MS detector, requiring more frequent instrument maintenance.

Acknowledgements:

This material is based upon work supported by the National Science Foundation under Grant No. EPS-0447675. Any opinions, findings, and conclusions or recommendations expressed in this material are those of the author(s) and do not necessarily reflect the views of the National Science Foundation.

References:

- Hwang, H.M., Foster, G.D. "Characterization of polycyclic aromatic hydrocarbons in urban stormwater runoff flowing into the tidal Anacostia River." *Environmental Pollution* 140, 416-426. 2005
- Pitt, R., Roberson, B., Barron, P., Ayyoubi, A., and Clark, S. *Stormwater Treatment at Critical Areas: The Multi-Chambered Treatment Train (MCTT)*. U.S. Environmental Protection Agency, Water Supply and Water Resource Division. National Risk Management Research Laboratory. EPA 600/R-99/017. Cincinnati, OH. 1999.
- SIS. *AutoDesorbTM Operation Manual, Autodesorb Model 2000*. (available from Scientific Instrument Services, Inc. Ringoes, NJ)
- SW-846 On-line. *Test Methods*, U.S. Environmental Protection Agency. (Available at <http://www.epa.gov/epaoswer/hazwaste/test/main.htm>)
- Toxicological profile for Polycyclic Aromatic Hydrocarbons (PAHs). Agency for Toxic Substances and Disease registry, Atlanta, GA. August 1995. (Available at: <http://www.atsdr.cdc.gov/toxprofiles/tp69.html#bookmark03>)

WASTEWATER AND WATER TREATMENT

Phytomanaging Firing Range Soils Using *Cyperus esculentus*

Afrachanna D. Butler, Maria F. Begonia and Victor Medina
US Army Engineer Research and Development Center
Environmental Laboratory/EP-E
3909 Halls Ferry Road
Vicksburg, MS 39180
601-634-3575
E-mail: Afrachanna.D.Butler@erdc.usace.army.mil

ABSTRACT

Firing range contamination is an issue that challenges the United States Military. The success of our armed forces depends upon realistic live-firing range training that includes the use of munitions and weapons during tactical and strategic operations. Concerns have increased regarding environmental effects from testing and training activities on these sites. Because of incomplete combustion and detonation, explosive contamination has documented at some ranges and has resulted in restriction of training activities.

Two commonly used explosives, hexahydro-1,3,5-trinitro-1,3,5-triazine (RDX) and trinitrotoluene (TNT) have contributed to soil and groundwater contamination on and nearby firing range sites. Because live ammunition training is still needed, the cleanup of these contaminants may prove to be expensive. Also, applying environmental maintenance designed to support other uses could interfere with routine training and testing operations. To avoid high cost and site interferences, an alternative being considered is the use of native grasses to phytomanage military firing ranges. Phytomanagement involves the phytoremediation technology which uses live plants for in situ and ex situ remediation of contaminated soil, sludges, sediments and groundwater. Research studies have indicated that phytoremediation is effective which concludes that it could be a useful approach at active firing ranges.

The objectives of this study are to evaluate and develop a cost-effective management technology to control active range contaminant migration and promote on-site contaminant degradation. Our study uses *Cyperus esculentus* (Yellow Nutsedge) as its remedial tool. Outdoor lysimeter cells were designed to mimic a practical firing range setting. Natural rainfall is the main source of irrigation; however, rain assimilation will be performed if needed. Leachate and runoff from the soil surface are collected. The anticipated result of this research is to stabilize the contaminants and reduce the amount of RDX and TNT in the soil surface runoff and leachate.

Keywords: sediment, toxic substances, solute transport, surface water, and treatment



SURFACE WATER QUALITY

Water Quality and Floristic Quality Assessments of the Big Sunflower River Following Streamflow Augmentation using Groundwater

Todd Tietjen and Gary Ervin
Department of Wildlife and Fisheries, Mississippi State University

Fluctuating Asymmetry and Condition in Fishes Exposed to Varying Levels of Environmental Stressors

Brianna Zuber and Jacob F. Schaefer
Department of Biological Sciences The University of Southern Mississippi

Water Quality Modeling in Support of the Mississippi Sound Coastal Improvement Program

Mansour Zakikhani, Mark S. Dortch, Mark R. Noel, Sung-Chen Kim, Carl F. Cerco, Phu V. Luong, and
Raymond S. Chapman
The U.S. Army Engineer Research and Development Center, Waterways Experiment Station

Mississippi Benthic Macroinvertebrate Tolerance Values for use in Surface Water Quality Assessment

Matthew Hicks, David W. Bressler, James B. Stribling, Michael J. Paul
Mississippi Museum of Natural Science and Tetra Tech, Inc.

SURFACE WATER QUALITY

Water Quality and Floristic Quality Assessments of the Big Sunflower River Following Streamflow Augmentation using Groundwater

Todd Tietjen and Gary Ervin
Department of Wildlife and Fisheries
Mississippi State University
Mail Stop 9690
Mississippi State MS 39762
662-325-2996
E-mail: ttietjen@cfr.msstate.edu

ABSTRACT

The Big Sunflower River is listed on the EPA Section 303(d) list of Impaired Waterbodies of Mississippi. Contributing to the decline in conditions in this system are the substantial decreases in base flow during the late summer and fall as groundwater levels decline. In an attempt to improve water quality and ecological conditions the Yazoo Mississippi Delta Joint Water Management District has begun supplementing flows during this critical period using groundwater. To assess the impact of streamflow augmentation we evaluated water quality trends through the 2006-2007 pumping period and assessments of the quality of the riparian plant community. Measurements of water quality (Temperature, Dissolved Oxygen, pH, Specific Conductance and Turbidity) were made at 11 locations on the Sunflower River between Indianola and North Clarksdale, at one location associated with the augmentation pumps and 1 location along the channel used to funnel pumped water to the Sunflower River. In general water quality was better above Clarksdale, with improvements in dissolved oxygen concentrations associated with increased flows and decreased temperatures. The riparian plant community was analyzed over a more focused portion of the upstream drainage basin with 2 sites south of Clarksdale, 2 sites north of Clarksdale and 1 within the city itself. Clarksdale represented a clear break in plant composition with higher numbers of monocots, invasive species and weedy early succession species encountered upstream (North) of Clarksdale. Taken together there is some indication that supplementing natural stream discharge may have beneficial impacts on water quality in the near term and in broader measures of ecosystem quality in the long term.

Keywords: Ecology, Surface Water, Water Quality, Wetlands

SURFACE WATER QUALITY

Fluctuating Asymmetry and Condition in Fishes Exposed to Varying Levels of Environmental Stressors

Brianna Zuber and Jacob F. Schaefer
Department of Biological Sciences
The University of Southern Mississippi
118 College Drive #5018
Hattiesburg, MS 39406-0001
601-266-6258
E-mail: ZBrianna@gmail.com

ABSTRACT

The ability of an organism to combat developmental stress is known as developmental stability which can be assessed by measuring fluctuating asymmetry. Fluctuating asymmetry (FA) is the variation in bilaterally symmetrical traits. Deviations in bilateral traits from perfect symmetry may point to developmental stress. Environmental factors or stressors such as chemical pollution have been shown to decrease developmental stability and increase levels of FA in several studies, but links between FA and condition as a measure of fitness in the literature are rare and needed.

The purpose of this study is to determine if fluctuating asymmetry (FA) and correlates of fitness are good indicators of stress. Sites were selected at approximately 3, 6, 12, and 26 kilometer increments upstream and downstream from the Leaf River Pulp Mill, New Augusta, MS. Collections of approximately twenty fish from each of three species: the longear sunfish (*Lepomis megalotis*), the blacktail shiner (*Cyprinella venusta*), and the highfin carpsucker (*Carpionodes velifer*), were made in early summer, late summer, and late fall of 2006. Several morphometric measurements were taken from each fish to determine the degree of FA. These included lateral line scale count, pectoral and pelvic fin ray count, length of longest pectoral fin ray, eye diameter, and head length. Gonadosomatic index (GSI), percent lipids, fecundity, and length/weight residual were measured as correlates of fitness.

The purpose of this study is to address the following questions: 1) Is there any difference in measures of FA and condition that correlate with position (upstream or downstream) from the source? 2) Is there any difference in measures of FA and condition that correlate with water column position of fishes?

Keywords: toxic substances, water quality, nonpoint source pollution, fluctuating asymmetry

Introduction

When wood is processed to make pulp, large quantities of organic material are produced and often discharged into local streams by pulp mills. There is a high probability that effluent from pulp mills will contain chemical pollutants that will be released into the water along with particulate matter left over from the manufacturing processes (Pearson, 1972). Dioxin is one of the most toxic of all substances that have been tested. Dioxin is also significant byproduct of pulp manufacturing that has been found to cause deformities and

cancer in many laboratory animals (Harrison and Hoberg, 1991; Zala and Penn, 2004).

A stressor is considered to be anything that disturbs an organism's homeostasis (Bonga, 1997). Stress that occurs during development (developmental stress) can have adverse effects on an organism's growth (Bonga, 1997; Campbell, 2003). The ability of an organism to combat developmental stress is known as developmental stability (Moller, 1997). One way to gauge developmental stability is by measuring fluctuating asymmetry (Van Valen, 1962; Felley, 1981;

Zuber and Schaefer

Kozlov et al., 1996; Simmons et al., 1999; Floate and Fox, 2000; Klingenberg et al., 2002;). Fluctuating asymmetry (FA) is variation in bilaterally symmetrical traits from perfect symmetry (Felley, 1980; Kozlov et al., 1996; Floate and Fox, 2000; Hogg et al., 2001). Bilateral traits are produced by the same genome. Hence, if an organism was not under stress during its development, one would expect perfectly symmetrical bilateral traits and no measurable FA (Campbell, 2003). Deviations from perfect symmetry could point to developmental stress (Hogg et al., 2001). Environmental factors or stressors such as chemical pollution and heavy metals have been shown to decrease developmental stability and increase levels of FA (Kozlov et al., 1996; Floate and Fox, 2000; Hasson and Rossler, 2002).

Fluctuating asymmetry may serve as a useful indicator of biological perturbations. Currently, one of the main methods used to determine communities or ecosystems under stress is by documenting the loss of indicator species (Chase et al., 2000). A problem with this practice is that organisms possess different characteristics that allow them to utilize resources differently, and the disappearance of certain indicator species may be a result of predation or population density pressures and not necessarily because of pollution or other environmental factors (Landres et al., 1988). FA may be a better technique for identifying populations or individuals under stress than other techniques such as presence or absence of indicator species.

The purpose of this study is to determine if FA and correlates of fitness change with distance from a source of contaminants. Body condition as a measure of fitness is expected to decrease with increasing stress levels, and levels of FA are expected to increase with increasing stress levels. Also, links between FA and condition as a measure of fitness in the literature are rare and needed. I propose to measure fluctuating asymmetries and putative correlates of fitness such as gonadosomatic index (GSI), fecundity, length/weight residual and percent lipids in three species of fishes, *Lepomis megalotis*, *Cyprinella venusta*, and *Carpionodes velifer*.

Study Species

Three species of fishes were chosen because they were found in high abundances in collections taken from the Leaf River by Ross (1990) and the National Council for Air and Stream Improvement (NCASI, 2002-2003): *Cyprinella venusta*, *Lepomis megalotis*, and *Carpionodes velifer*. More specifically these species were chosen because a representative from each trophic position was desired to determine if proximity to contaminants in sediments affects correlates of fitness and/or FA. *Cyprinella venusta*, the blacktail shiner, is found mostly in the water column, typically spawns during late spring and early summer, and feeds on mostly insect larvae (Hambrick and Hibbs, 1977). *Lepomis megalotis*, the longear sunfish, can be found in all levels of the water column, typically spawns during late spring and early summer (Berra and Gunning, 1972), and feeds on aquatic insects and other fishes (Applegate et al., 1967). *Carpionodes velifer*, the highfin carpsucker, is a benthic fish that spawns from early summer to early fall and feeds mostly on detritus and algae (Beecher, 1979). According to Funk (1955) and Baker and Ross (1981), *L. megalotis* has a limited home range. Berra and Gunning (1972) estimate the home range of *L. megalotis* to be roughly 21-61 m while the home ranges of *C. venusta* and *C. velifer* are both considered to be much greater.

Study Area

The Leaf River originates in Scott County, Mississippi and flows southward through Hattiesburg (Figure 1). It continues a southeastwardly course through George County where it joins the Chickasawhay River and forms the Pascagoula River. Sites were selected at approximately 3, 6, 12, and 26 kilometer increments upstream and downstream from the Leaf River Pulp Mill, New Augusta, MS (Figure 1).

Materials and Methods

Sampling was done in July, September, and December of 2006 around sand bars of the Leaf River in the study area using cast nets and seines. Seines were of variable sizes but

SURFACE WATER QUALITY



Figure 1. Map of southern Mississippi with study area on the Leaf River outlined in black. Inset shows the location of the sites in the study area. The letter U on site labels represents upstream sites, and the letter D represents downstream sites.

mesh was always 4.8 mm. Twenty individuals of each species were collected from each of the eight sites during each sampling trip. Fishes were fixed in 10% formalin immediately after collection and later transferred to 5% buffered formalin (Huelett et al., 1995).

Phenotypic Measurements and Measures of Condition

Several bilateral phenotypic measurements were taken from each fish, including lateral line scale count (Felley, 1980), pectoral and pelvic fin ray count (Gross et al., 2004), length of longest pectoral fin ray, eye diameter, and head length (Bryden and Heath, 2000; Prieto et al., 2005). Several measures of condition were calculated from each fish, including gonadosomatic index (GSI), gonad weight relative to eviscerated body weight (Johnston and Knight, 1999); fecundity, the number of mature ova per female estimated from a subsample following the methods of Wagner and Cooper

(1963); percent (%) lipids, and Fulton's condition index, a method commonly used to analyze fish condition by calculating weight in grams relative to standard length in millimeters cubed (Hoque et al., 1998).

% Lipids

Percent lipids is of particular interest because Eckmann (2004) found when measuring many indices of condition in juvenile rainbow trout with increasing food deprivation, % lipids showed the greatest difference (Bonferroni posteriori tests after Two-Way ANOVA, $P = < 0.001$). Many different methods have been utilized to determine total lipids in fishes, but for this study, we have chosen to use the petroleum ether method employed by Heulett et al. (1995). The fish were eviscerated to remove any food items that could influence lipid results, and gonads removed from fish to calculate GSI were placed back in the body cavity. Each fish was ground up using a mortar and pestle, and a portion of the ground fish was placed in a glass vial. The vials had been labeled and weighed prior to addition of the ground fish. The vials were placed in a drying oven for 48 hours and then moved to a desiccator at 0% humidity for 48 hours. The vials were removed from the desiccator and weighed to determine dry weight. Next, each vial underwent three petroleum ether washes. Approximately 2 milliliters of petroleum ether was added to each vial, the vials were covered and allowed to sit for 45 minutes to one hour, and the petroleum ether was removed. This was repeated for each wash. The vials were placed back in the drying oven for 48 more hours and then moved to the desiccator for 48 hours. Vials were removed from the desiccator and weighed again. Pre and post extraction weights were used to determine the percent of each fish that was storage lipids.

We quantified FA as the Euclidian distance in ordination space between left and right side traits for each individual. All left traits were run in a principle components analysis (PCA) that accounted for 93% of the variability in left traits among the first two axes. Right side traits were projected onto that ordination by summing the standardized products of factor scores and measurements for each trait. FA for an individual was then quantified as the distance in two-dimen-

SURFACE WATER QUALITY

Fluctuating Asymmetry and Condition in Fishes Exposed to Varying Levels of Environmental Stressors

Zuber and Schaefer

sional ordination space between the left side score and the projected right side score for each individual. For example, a perfectly symmetric fish would have identical left and right side measures and the projected right side point would have a Euclidian distance of 0.0 from the left side. The more asymmetric the measures, the greater the distance between the left side and projected right side measures.

Results

The following results are from analyzing 20 *Cyprinella venusta* from the 3 km upstream site and 20 *Cyprinella venusta* from the 3 km downstream site (Figure 1).

Fluctuating Asymmetry

There was no significant difference in levels of FA measured in the fish from the 3 km upstream sites compared to fish from the 3 km downstream. Fish from the upstream site showed slightly higher levels of FA than fish from the downstream site (Figure 2). A simple linear regression model was used to detect any correlation between FA and percent lipids ($p \leq 0.84$, $r^2 = 0.001148$, $FA = 0.6958664x - 0.0090148$ % lipids) and between FA and index of condition ($p \leq 0.93$,

$r^2 = 0.00026$, $FA = 0.5935808x - 5275.2682$ index of condition). Neither was significant, but both showed a slight positive correlation with percent lipids and condition increasing as levels of FA decreased.

Condition

A simple linear regression model was used to detect any correlation between percent lipids and condition ($p \leq 0.79$, $r^2 = 0.001847$, % lipids = $21.237133x + 52889.862$ index of condition). There was no significant correlation, but there was a trend as condition increased slightly with an increase in percent lipids. A One-Way Analysis of Variance (ANOVA) of fecundity by site (upstream (U) mean = 243.3, downstream (D) mean = 123.1, $p \leq 0.08$) showed no significant difference in fecundity in fish collected from the downstream site compared to fish collected from the upstream site, but fish from the upstream site showed slightly higher fecundity than did fish from the downstream site. A One-Way ANOVA of GSI by site (U mean = 4.76, D mean = 2.30, $p \leq 0.01$) detected a significant difference in the GSI of fish collected from the downstream site compared to fish collected from the upstream site with fish from the upstream

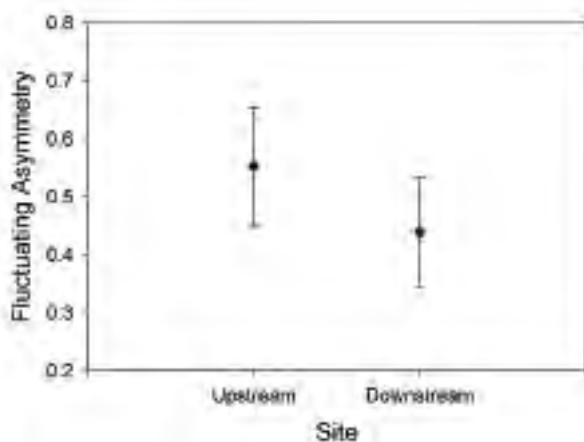

Figure 2. Mean levels of FA of fish collected from upstream and downstream sites.

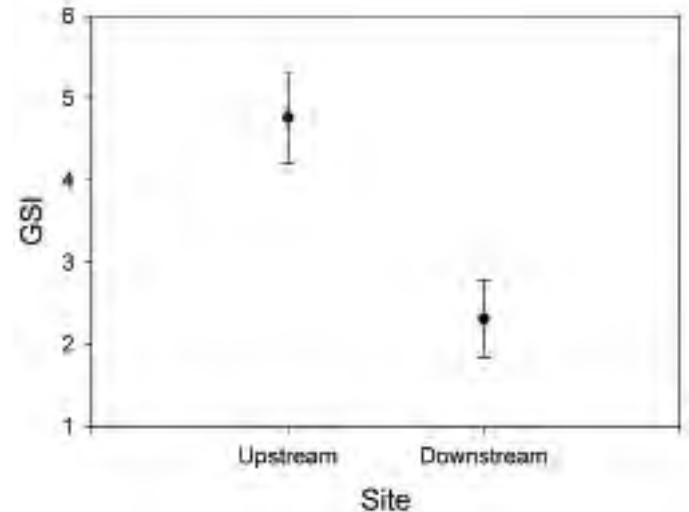

Figure 3. GSI of fish collected from upstream and downstream sites.

SURFACE WATER QUALITY

site showing higher GSI than fish from the downstream site (Figure 3). A One-Way ANOVA of condition by site showed no significant difference in Fulton's condition index in fish from the upstream site compared to fish from the downstream site, but condition was higher in fish from the upstream site. A One-Way ANOVA showed no difference in percent lipids by site (U mean = 22.18, D mean = 22.26, $p \leq 0.89$).

Discussion

There were no significant differences in fish collected from the upstream site compared to fish collected from the downstream site with regards to FA, fecundity, condition, or percent lipid. Levels of FA were unexpectedly higher at the upstream site. Condition and fecundity were slightly higher at the upstream site as well while percent lipid was relatively the same in fish from the upstream and downstream sites. The only significant difference occurred when analyzing GSI. GSI was found to be significantly higher in fish collected from the upstream site. FA showed no significant correlation with percent lipid or condition, but there was a trend of percent lipid and condition increasing with decreasing levels of FA. The same trend was seen in the correlation between percent lipid and condition.

The results so far are only preliminary and show little difference in fish upstream and downstream of the pulp mill, but this is only after analyzing 40 fish from one species. In the future, many more fishes will be analyzed. If 20 fish from each of the 3 species are collected from each of the 8 sites 4 times in total (20x3x8x4), approximately 1,920 fishes will be analyzed. All species will be analyzed to determine what effects, if any, movement and diet have on condition and levels of FA. The detritivore, *C. velifer*, is expected to show greater levels of FA and lower condition because of its proximity to the contaminants found in the particulate matter of the pulp mill effluent. Similarly, *L. megalotis* may also be exposed to contaminants via floating particulate matter. Home range and movement may also have an effect on condition and levels of FA. *L. megalotis* has been shown to have a small home range while *C. venusta* and *C. velifer* have larger home ranges, and their high degree of movement up and downstream may influence any impact the pulp mill effluent

may have on them.

Literature Cited

Applegate, R.L., J.W. Mullanm and D.I. Morais. 1967. Food and growth of six centrarchids from shoreline areas of Bull Shoals Reservoir. Proc. S.E. Assoc. Game Fish Comm. 20: 469-482.

Baker, J.A. and S.T. Ross. 1981. Spatial and temporal resource utilization by southeastern cyprinids. Copeia 1981 (1): 178-189.

Beecher, H.A. 1979. Comparative functional morphology and ecological isolating mechanisms in sympatric fishes of the genus *Carpoides* in northwestern Florida. Ph.D. dissertation, Florida State University, Tallahassee.

Berra, T. M. and G.E. Gunning. 1972. Seasonal movement and home range of the longear sunfish, *Lepomis megalotis* (Rayfinesque) in Louisiana. American Midland Naturalist 88 (2): 368-375.

Bonga, S.E.W. 1997. The stress response in fish. Physiological Reviews 77 (3): 591-625.

Bryden, C.A. and D.D.Heath. 2000. Heritability of fluctuating asymmetry for multiple traits in Chinook salmon (*Oncorhynchus tshawytscha*). Canadian Journal of Fisheries and Aquatic Sciences 57 (11): 2186-2192.

Campbell, W. Bruce. 2003. Assessing developmental errors in branchiostegal rays as indicators of chronic stress in two species of Pacific salmon. Canadian Journal of Zoology 81: 1876-1884.

Chase, M.K., Kristan, W.B. III, Lynam, A.J., Price, M.V., and J.T. Rotenberry. 2000. Single species as indicators of species richness and composition in California coastal sage scrub birds and small mammals. Conservation Biology 14 (2): 474-487.

Eckmann, R. 2004. Overwinter changes in mass and lipid

SURFACE WATER QUALITY

Fluctuating Asymmetry and Condition in Fishes Exposed to Varying Levels of Environmental Stressors

Zuber and Schaefer

- content of *Perca fluviatilis* and *Gymnocephalus cernuus*. *Journal of Fish Biology* 65: 1498-1511.
- Felley, James. 1980. Analysis of morphology and asymmetry in bluegill sunfish (*Lepomis machrochirus*) in the southeastern United States. *Copeia* 1980 (1): 18-29.
- Floate, K.D. and A.S. Fox. 2000. Flies under stress: a test of fluctuating asymmetry as a biomonitor of environmental quality. *Ecological Applications* 10 (5): 1541-1550.
- Funk, J.L. 1955. Movement of stream fishes in Missouri. *Trans. Amer. Fish. Soc* 85: 39-57.
- Gross, M.C., C.H. Schneider, M.C. Matiello, M. Leite, L.A.C. Bertollo III, and R.F. Artoni. 2004. Population structure, fluctuating asymmetry and genetic variability in an endemic and highly isolated *Astyanax* fish population (Characidae). *Genetics and Molecular Biology* 26 (4): pages.
- Hambrick, P.S. and R.G. Hibbs, Jr. 1977. Feeding chronology and food habits of the blacktail shiner *Notropis venustus* (Cyprinidae), in Bayou Sara, Louisiana. *Southwestern Naturalist* 22 (4): 511-516.
- Harrison, K. and G. Hoberg. 1991. Setting the environmental agenda in Canada and the United States: the cases of dioxin and radon. *Canadian Journal of Political Science* 24 (1): 3-27.
- Hasson, O. and Y. Rossler. 2002. Character-specific homeostasis dominates fluctuating asymmetries in the medfly (Diptera: Tephritidae). *Florida Entomologist* 85 (1): 73-82.
- Heulett, S.T., S.C. Weeks, and G.K. Meffe. 1995. Lipid dynamics and growth relative to resource level in juvenile eastern mosquitofish (*Gambusia holbrooki*: Poeciliidae). *Copeia* 1995 (1): 97-104.
- Hogg, I. D., J. M. Eadie, D.D. Williams, and D. Turner. 2001. Evaluating fluctuating asymmetries in a stream-dwelling insect as an indicator of low-level thermal stress: a large-scale field experiment. *Journal of Applied Ecology* 38: 1326-1339.
- Hoque, M.T., R.M. Yusoff, T. Law, and M.A. Syed. 1998. Effect of hydrogen sulphide on liver somatic index and Fulton's condition factor in *Mystus nemurus*. *Journal of Fish Biology* 52: 23-30.
- Johnston, C.E. and C.L. Knight. 1999. Life history traits of the bluenose shiner, *Pteronotropis welaka* (Cypriniformes: Cyprinidae). *Copeia* 1999 (1): 200-205.
- Klingenberg, C.P., M. Barluenga, and A. Meyer. 2002. Shape analysis of symmetric structures: quantifying variation among individuals and asymmetry. *Evolution* 56 (10): 1909-1920.
- Kozlov, M.V., B.J. Wilsey, J. Koricheva, and E. Haukioja. 1996. Fluctuating asymmetry of birch leaves increases under pollution impact. *Journal of Applied Ecology* 33: 1489-1495.
- Landres, P.B., J. Verner, and J.W. Thomas. 1988. Ecological uses of vertebrate indicator species: a critique. *Conservation Biology* 2: 316-328.
- National Council for Air and Stream Improvement. 2005. Long-term receiving water study data compendium: September 2002 to August 2003. Technical Bulletin No. 897.
- Pearson, T.H. 1972. The effect of industrial effluent from pulp and paper mills on the marine benthic environment. *Proc. R. Soc. Lond. B.* 180: 469-485.
- Ross, S. T., S.D. Wilkins, W. M. Breneman and J. S. Peyton. 1990. Distributions and Biology of Fishes in the Leaf River, Mississippi. Department of Biological Sciences, University of Southern Mississippi, Hattiesburg, Mississippi 39406-5018. 105 pp.

SURFACE WATER QUALITY

Simmons, L.W., J.L. Tomkins, J.S. Kotiaho, and J. Hunt. 1999. Fluctuating paradigm. *Proc. R. Soc. Lond. B.* 266: 593-595.

Van Valen, Leigh. 1962. A study of fluctuating asymmetry. *Evolution* 16 (2): 125-142.

Wagner, C.C. and E.L. Cooper. 1963. Population Density, growth, and fecundity of the creek chubsucker, *Erimyzon*

oblongus. *Copeia* 2: 350-357.

Zala, S.M. and D.J. Penn. 2004. Abnormal behaviours induced by chemical pollution: a review of the evidence and new challenges. *Animal Behaviour* 68: 649-664.

SURFACE WATER QUALITY

Water Quality Modeling in Support of the Mississippi Sound Coastal Improvement Program

Mansour Zakikhani, Mark S. Dortch, Mark R. Noel, Sung-Chen Kim, Carl F. Cerco, Phu V. Luong, and
Raymond S. Chapman

The U.S. Army Engineer Research and Development Center (ERDC)
Waterways Experiment Station
3909 Halls Ferry Road
Vicksburg, MS 39180-6199
601-634-3806

E-mail: Mansour.Zakikhani@erdc.usace.army.mil

ABSTRACT

Mississippi Sound of the northern Gulf of Mexico extends from Lake Borgne in Louisiana on the west to Mobile Bay in Alabama on the east. Cat, Horn, Petit Bois, and Dauphin are the main islands. The total surface area of Mississippi Sound is approximately 500,000 acres; 25 percent is classified as near shore habitat with less than two meters (6.5 feet) deep, and 75 percent is offshore habitat.

In response to major damages on the Mississippi coast caused by Hurricane Katrina, Congress has directed the U.S. Army Corps of Engineers to conduct the Mississippi Sound Coastal Improvements Program (MSCIP), which is an analysis and design for comprehensive improvements, or modifications to existing improvements, in the coastal areas of Mississippi in the interests of: (1) hurricane storm damage reduction, (2) prevention of saltwater intrusion, (3) preservation of fish and wildlife, (4) prevention of erosion, and (5) other related water resource purposes. Several measures are under consideration for restoring resources along the coast including: construction of dunes, seawalls, and levees on shore; development of surge mitigation measures; wetland and ecosystem restoration; barrier island and beach restoration; and freshwater diversion.

Mathematical models are being used within MSCIP to help evaluate the effects of barrier island restoration and freshwater diversions. This paper describes the application of a three-dimensional water quality model of the Mississippi Sound region to evaluate the impacts of freshwater diversion alternatives on water quality.

The water quality model (WQM), which is based on the CE-QUAL-ICM water quality model code, is coupled to output from a three-dimensional hydrodynamic model of the region, which is based on the CH3D hydrodynamic model. The version of CH3D with sigma coordinates in the vertical dimension is being used. The model grid extends seaward beyond Chandelier Island and includes Mobile Bay, Lake Borgne, Lake Pontchartrain, the Inner Harbor Navigation Channel of New Orleans, and the Mississippi River Gulf Outlet channel.

Predicted water quality constituents, including nutrients, phytoplankton, dissolved oxygen, temperature, salinity, and underwater light intensity, are being evaluated for each alternative and compared to modeled existing, baseline conditions to assess relative changes. Output from the model also will be available for use in habitat quality evaluations.

Keywords: Freshwater Diversions, Nutrients, Surface Water, Numerical Models

SURFACE WATER QUALITY

Introduction

In response to major damages on the Mississippi coast caused by Hurricane Katrina, Congress has directed the U.S. Army Corps of Engineers to conduct the Mississippi Sound Coastal Improvements Program (MSCIP), which is an analysis and design for comprehensive improvements, or modifications to existing improvements, in the coastal areas of Mississippi in the interests of: (1) hurricane storm damage reduction, (2) prevention of saltwater intrusion, (3) preservation of fish and wildlife, (4) prevention of erosion, and (5) other related water resource purposes. Several measures are under consideration for restoring resources along the coast including: construction of dunes, seawalls, and levees on shore; development of surge mitigation measures; wetland and ecosystem restoration; barrier island and beach restoration; and freshwater diversion.

Freshwater diversions will not only lower salinity, but can also increase nutrient and suspended solid concentrations due to anthropogenic loadings into major rivers, such as the Mississippi River, that may be used for such diversions. Higher nutrient concentrations, primarily nitrogen, can fuel larger phytoplankton blooms. Increased suspended solids and phytoplankton biomass can reduce the amount of light available for submerged aquatic vegetation (SAV), which is important as habitat for living resources. Increased eutrophication, concomitant with more turbid water and elevated algal concentrations, is generally considered undesirable for environmental quality. There is also the possibility of lower dissolved oxygen during periods when the water column may stratify. Thus, any considerations for freshwater diversions should include an analysis of the impacts on water quality.

The objective of this study was to develop and apply a water quality model of the Mississippi Sound and surrounding region to provide key information for evaluating coastal restoration and improvement alternatives. The results presented in this report focus on the water quality conditions that could be imposed with three freshwater diversion alternatives that are being considered.

The scope of this study was limited to providing enough information to allow for screening of alternatives and evaluating the sensitivity of the system to diversions, not to provide refined forecasts of future water quality conditions with diversions. The model will require more attention to provide refined forecasts, and such effort may be warranted if preferred alternatives progress to a more in-depth level of analysis and plan formulation.

Three-dimensional (3D) hydrodynamic (CH3D-sigma level vertical coordinates) model code was used for the hydrodynamic model (Chapman et al. 1996), and the CE-QUAL-ICM (ICM) model code was used for water quality. The modeling grid, shown in Figure 1, consists of 172 x 405 rows and columns and 40,406 active computational cells in plan-form. Five vertical sigma layers were used resulting in a total of 202,030 active cells. ICM was first developed for Chesapeake Bay (Cercio and Cole 1993) but has subsequently been used for many diverse systems. A more recent version of ICM (Cercio et al. 2004) was used for the present study. A detailed description of this version of ICM is described in the report by Cercio et al. (2004).

Given the limited data availability and the limited scope of this study, some of the more comprehensive WQM routines were not activated, such as the sediment diagenesis, benthic algae, and submerged aquatic vegetation (SAV) routines. For these routines to provide added value, it would be necessary to simulate a multi-year period. Typically five or more years of simulation are required for bottom sediments to re-equilibrate for changing nutrient loads. Given the size of this grid, this would have required significant super-computing requirements and a longer study time with greater funding. Additionally, much more observational data would have been required for model calibration and validation than was available. The results of the WQM should still be representative of future alternative conditions given the mostly unstratified conditions of the Sound, which diminishes the importance of sediment nutrient processes and their influence on the water column. The model also provides underwater light attenuation that can be used to infer impacts on SAV,

which is of interest for habitat. If other model compartments are needed in a future study, they can be activated at that time.

Additional inputs of freshwater flows and tributary nutrient loads were included as required after extending the model domain. Model calibration was conducted again using the spring-summer 1998 conditions and observations, as was used for the Gulfport study. The WQM was executed for April 1 through September 30, 1998, conditions when running baseline and scenario alternatives. The HM was run for the same period, except the month of March was also included to improve model spin-up.

Water Quality Model Description

CE-QUAL-ICM (ICM) was designed to be a flexible, widely applicable, state-of-the-art eutrophication model. Initial application was to Chesapeake Bay (Cercio and Cole 1993). Since the initial Chesapeake Bay study, the ICM model code has been generalized with various revisions and improvements. Subsequent additional applications of ICM included the Delaware Inland Bays (Cercio et al. 1994), Newark Bay (Cercio and Bunch 1997), the San Juan Bay Estuary (Bunch et al. 2000 and Cercio et al. 2003), Florida Bay (Cercio et al. 2000), St. Johns River (Tillman et al. 2004), Pascagoula River Harbor (Bunch et al. 2003), Lake Washington (Cercio et al. 2004), and the Port of Los Angeles other sites. Each model application employed a different combination of model features, and some applications required the addition of new capabilities to more fully capture the system dynamics.

ICM requires the flow data using a hydrodynamic model such as CH3D. Hydrodynamic variables (i.e., flows, vertical turbulent diffusion coefficients, and volumes) must be specified externally and read into the model. Hydrodynamics may be specified in binary or ASCII format and are usually obtained from a hydrodynamic model such as the CH3D model.

A limited number of variables and only one algal group were activated due to the limited amount of observed data needed for model calibration. Particulate organic components were lumped into a single labile compartment for each

Table 1. Water quality model state variables for Mississippi Sound model.

Temperature	Salinity
Fixed Solids (inorganic suspended solids)	Dissolved Oxygen (DO)
Dissolved Organic Carbon (DOC)	Particulate Organic Carbon (POC)
Ammonium (NH ₄) Nitrogen	Nitrate + Nitrite Nitrogen (NO ₃)
Dissolved Organic Nitrogen (DON)	Particulate Organic Nitrogen (PON)
Total Phosphate or total inorganic phosphorous (TIP)	Dissolved Organic Phosphorus (DOP)

major nutrient. Inorganic suspended solids were included in addition to organic solids and algae due to the interest in changes in the light climate or light attenuation resulting from the introduction of additional freshwater that can result in elevated suspended solids concentrations. For this study, 14 state variables of ICM were activated and are listed in Table 1.

Model Input Data

The WQM requires loadings and boundary conditions, initial conditions, and model parameters including various process rate coefficients. The WQM inputs are described within this section.

Loadings and Boundary Concentrations

Loadings for all sources of nutrients and sediment must be specified for the model. These include loadings from inflowing rivers, atmospheric deposition, and other sources, such as local distributed runoff and major point source (e.g., waste water discharge) loadings. Of these, the primary inputs are from rivers and the atmosphere, thus, loadings from local distributed runoff and point source waste water discharges, including storm water drains, were not included in the model for this study. Methods for deriving estimates for riverine and atmospheric loadings are discussed in this section.

SURFACE WATER QUALITY

Additionally, boundary concentrations must be specified along all boundary flow faces for all water quality state variables, unless a variable is treated as a point source load instead as done for some rivers as explained below. Open water (ocean) boundary concentrations must be specified for all state variables. Boundary concentration data for rivers and ocean are also discussed and presented within this section.

River Boundary Concentrations and Loadings

River loadings can be specified either of two ways in the model. One way is to specify the concentrations at the model boundaries where the river flows enter. This approach requires that the boundary has flows from the hydrodynamic model. The product of flow and concentration is load (mass/time). The other approach is to specify the loading as a point source load (kg/day) for the model cell where the river enters. This approach does not require a flow from the hydrodynamic model at the boundary although flows are provided for all major inflowing rivers in this study. River boundary concentrations should be set to zero for all state variables that are treated as point source loads. Both methods were used for this model study for nutrients. Some water quality variables are best specified as a concentration at the river inflow boundary, such as temperature, dissolved oxygen, and salinity. Salinity was set to 0.0 parts per thousand (ppt) for all river inflow boundaries. Other water quality variables are best specified as loads, such as nutrients, if data are available to determine loads. The boundary condi-

tions for each river inflow are explained below. The rivers included in the model are shown in Figure 1. Data used in this study are provided in Dortch et al. (2007).

Atmospheric Loadings

Goolsby et al. (1999) summarizes a literature review of atmospheric loading of nitrogen to the Gulf of Mexico. They report that wet deposition of N is an order of magnitude or more than dry deposition, thus, dry deposition can be ignored. Goolsby et al. (1999) report that the average wet deposition of inorganic N along the U.S. Gulf Coast is typically on the order of 3 to 4 kg/ha/yr with NO_3 accounting for about 60% of total N deposited. Using a value of 3.5 results in 2.1 and 1.4 kg/ha/yr for NO_3 and NH_4 , respectively. If these loadings are applied to the surface of Lake Pontchartrain with an area of 1,632 km² (Penland et al. 2002), a loading of 0.34 and 0.23 Mkg/yr for NO_3 and NH_4 , respectively, can be calculated and are less than half the values reported in Table 3-6. Goolsby et al. (1999) report that N loadings approach 7 kg/ha/yr for Gulf waters near southern Louisiana. They also state that values are higher closer to shore than out in the Gulf, with values of about 5.5 kg/ha/yr. Thus, a value of 5.5 was used for atmospheric TN loading in the model, which was entered as 3.3 and 2.2 kg/ha/yr NO_3 and NH_4 , respectively. This TN loading from the atmosphere distributed over the model domain of 17,280 km² is about a fourth as large as the TN loadings from the tributaries entering the model domain.

Out Gulf Boundary Concentrations

The U.S. Environmental Protection Agency (EPA) collected water quality data off-shore in Mississippi Sound during July 2002 at four stations (MS1, MS2, MS3, and MS4), which are shown in Figure 2. These data along with various assumptions were used to estimate the outer Gulf boundary conditions for water quality.

Variations in water quality variables over the depth were assumed to be small along the outer Gulf boundary, thus, a single value for each variables was assigned for each vertical layer of the model along the boundary. Temperature and DO were varied over time along the outer Gulf boundaries,

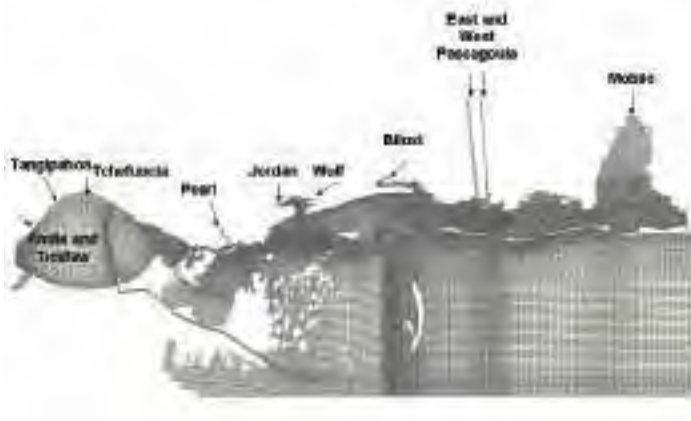

Figure 1. Locations of rivers included in the model.



Figure 2. EPA sampling stations for July 2002.

but other constituents were held constant over time. There are two outer Gulf boundaries, one along the south boundary running east-west outside the barrier islands, and one running north-south from the south boundary to the shore east of Mobile Bay. The same water quality boundary concentrations were used for both boundaries.

The same temperatures as used for the outer Gulf boundaries in the Gulfport Harbor model study (Bunch et al. 2005) were used in this study for those boundaries. Salinity values

along the two boundaries were the same as those used for the hydrodynamic model in this study along those boundaries, which were varied spatially (increasing salinity moving east and south) but held constant over time. Algal chlorophyll a concentrations are typically on the order of 1.0 $\mu\text{g/L}$ in the open ocean or sea away from the shore, so this value was assumed for the outer Gulf boundaries. The TOC measured at the EPA stations was 1.0 mg/L, so this was the value assumed for DOC with POC set to zero along the boundar-

SURFACE WATER QUALITY

ies. No values were measured at the EPA stations above the detection limit of 0.05 mg/L N for nitrate + nitrite nitrogen and ammonium nitrogen. Therefore, the open Gulf boundary values for these two water quality variables were set to 0.05 mg/L. Measured values for TKN at the EPA stations averaged 0.62 and 0.14 mg/L N for the western (MS1 and MS2) and eastern (MS3 and MS4) stations, respectively. The western stations are more heavily influenced by terrestrial loadings from tributaries entering in that region, whereas the eastern stations are more representative of conditions in the open Gulf. Thus, a value of 0.14 mg/L for TKN was used to estimate TON, or DON since PON was assumed to be zero along the outer Gulf boundaries. With ammonium of 0.05 mg/L and TKN of 0.14 mg/L, the calculated DON was 0.09 mg/L, which was applied along the outer Gulf boundaries. TP and total dissolved phosphorus (TDP) were measured at the EPA stations, but all values were below the detection limit of 0.025 mg/L P except for TP values that averaged 0.033 mg/L at the western stations. Thus, it was assumed that the phosphorus along the outer Gulf boundaries was TIP with a value of 0.025 mg/L. The DO concentrations for the outer Gulf boundaries were set equal to the computed DO saturation based on water temperature. TSS was measured at the EPA stations, but with the exception of one value of 8.0 mg/L at Station MS1, the other values were close to or below the detection limit of 4.0 mg/L. Thus, the outer Gulf boundary concentration for ISS was set to half the EPA station values, or 2.0 mg/L, since very little TSS would be expected this far out.

Initial Conditions

Initial conditions for water quality constituents were first set equal to those used for the Gulfport Harbor model study (Bunch et al. 2005), which were based upon observed data from MSDEQ. These initial concentrations for the water column (Dortch et al. 2007), were specified as uniform throughout the grid, i.e., same values for all cells in all layers. To provide more realistic, spatially varied, initial conditions, ICM was run for one month using the uniform initial conditions discussed above. Hydrodynamics and water quality bound-

ary conditions for April 1998 were used for this run. Water quality concentrations at the end of the month for all computational cells were saved to a file and were used as the initial conditions for a second month-long run, again using April 1998 hydrodynamics and water quality boundary conditions. The end of month concentrations were again saved for all cells and used as initial conditions for a third month-long run with the same hydrodynamics and water quality boundary conditions. Thus, three one-month-long runs were used to spin-up the initial conditions for water quality that were used for all subsequent model calibration and scenario runs.

Other Inputs

The ICM model requires various kinetic rate coefficients and other parameters to simulate water quality processes. All model parameters are described by Cerco et al. (2004) or in the draft user manual that was developed as a part of that study. Model parameters that were used for the final model calibration in the present study are presented in the Chapter 4 on Model Calibration.

Additionally, meteorological data are required for predicting temperature and photosynthetically active radiation (PAR), which affects plant growth. The model uses daily solar radiation incident on the water surface, equilibrium temperatures, and heat exchange coefficients (Edinger et al. 1974) to predict water temperature. These three variables are computed from a pre-processor program using meteorological data consisting of air temperature, dew point temperature, wind speed, and percent cloud cover. If measured solar radiation is available, then measured values can be used rather than computed values. Daily solar radiation is converted in the model to PAR for use in plant growth routines. Solar radiation and PAR are attenuated over the water depth due to water quality properties, including suspended solids and algal concentrations, for use in temperature simulation and plant growth. Meteorological data for 1998 from the airport in Mobile, AL, were used in this study. These meteorological data were obtained from the Air Force Combat Climatologic Center.

Model Calibration

A partial model calibration was performed due to the limited scope of this study. Hydrodynamics from CH3D were supplied to the WQM for March through September 1998 conditions. The WQM was executed for the period April through September 1998 for calibration.

Model calibration proceeded by making a limited number of runs with various adjustments to model kinetic coefficients and parameters. The primary parameters that were varied in the calibration simulations were particulate organic nitrogen and phosphorus hydrolysis rates, the dissolved organic nitrogen and phosphorus mineralization rates, the maximum nitrification rate, the suspended solids and algal settling rates, fractions of algal recycling and proportioned to various organic pools, carbon to chlorophyll ratio, algal half saturation constants for nutrient uptake, maximum photosynthesis rate for algal growth, and first order algal predation rate. The calibration was particularly sensitive to the mineralization and nitrification rates.

Model results were compared to observed data obtained from Mississippi Department of Environmental Quality (MSDEQ) for various stations throughout the Sound. Observations were not available for all variables at all stations. Additionally, stations were added that did not have observational data.

As noted previously, only a partial model calibration was performed due to the limited scope of this study. Therefore, the calibration is not as good as usually achieved with this model. Additionally, this system is quite large and complex, which complicated identifying and quantifying all the loadings. The model presently contains tributary and atmospheric loadings. However, there are other loadings, such as combined storm water outlets, waste water discharges, and local runoff that are not accounted for in the model. Including these additional loadings would require a substantial amount of additional work and time. Additionally, there is considerable uncertainty in the loadings that were provided in the model due to the lack of data. There was no attention given to calibrating the model for the back bays, which can be sensitive to localized loadings. Given a larger study scope, it would be possible to focus more on the back bays and

to add other observed data in the Gulf, such as data from the states of Alabama and Louisiana and possibly EPA and NOAA. Having additional data could help improve calibration.

Even though the calibration is not as complete as usually performed, the results are considered sufficient to meet the study objectives. The model can be used to make relative comparisons of water quality for diversion alternatives contrasted against baseline existing conditions, which is useful for evaluating the sensitivity of the system to freshwater diversions.

The model initial conditions were spun up one time during the first calibration run as explained in Dortch et al. (2007). These initial conditions were used for all subsequent runs including calibration and scenario runs. Ideally, the model's initial conditions should be spun-up for each new run whenever anything is changed in the model including calibration parameters and modified freshwater flows and loads. The additional spin-up runs were not conducted due to the need to meet the study schedule constraint. It can require a month or longer for the initial conditions to flush out, so some of the model results early in the simulation may not be as accurate as later in the simulation due to poor specification of initial conditions.

Scenario Results

The WQM was applied for three alternative scenarios: (1) diversion of freshwater flow from the Mississippi River at Bonnet Carre' spillway, (2) diversion of freshwater flow from the Mississippi River at Violet Marsh, and (3) diversion of all of the Escatawpa River flow into Grand Bay. The locations of the three diversions are introduced are shown in Figure 3. The Bonnet Carre' diversion varied by month and is shown in Figure 4. The Violet Marsh diversion was a constant flow of 212.4 cms (7500 cubic feet per second, cfs). The Escatawpa diversion is the flow that occurred in the Escatawpa River during 1998, and those values were varied daily in the model as shown in Figure 5. The WQM was applied for the period April through September 1998 using the same inputs as the final calibration run except for different hydrodynamics and different boundary conditions for the diverted flow

SURFACE WATER QUALITY



Figure 3. Observation station locations.

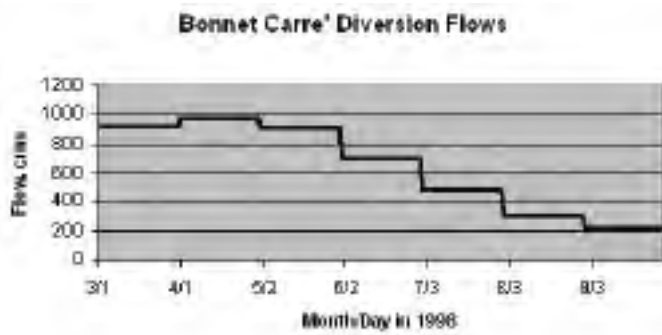

Figure 4. Bonnet Carre' diversion flows.

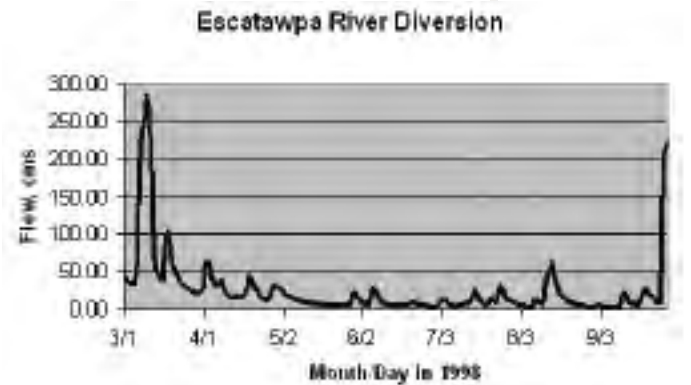

Figure 5. Escatawpa River diversion flows.

and associated concentrations of the flow. The HM was run with the same conditions as used for the base conditions used in the WQM calibrations for 1998 except that the additional freshwater flows were introduced. A separate HM run was made for each of the three diversions. The water concentrations characteristic of Mississippi River water, which were developed as discussed in Dortch et al. (2007), were associated with the first two freshwater diversion flows when executing the WQM. The water quality of the Pascagoula River was used for the Escatawpa diversion.

Results for the four scenarios (i.e., base, Bonnet Carre' diversion, Violet Marsh diversion, and Escatawpa River diversion) were post-processed to produce summer average (July - September) surface concentrations for 1998. The summer average results were computed for salinity, chlorophyll, light extinction, and TSS and are plotted as color contours in plan form throughout the model domain. These plots are presented for the four water quality constituents in Figures 6 - 9 where the four scenarios are grouped together in each figure for comparison.

Summer Average Concentration Contours

The effects of the Bonnet Carre' diversion are very apparent in the western portion the domain, whereas, in other parts of the domain, the changes are not as obvious unless one looks closely at the near shore conditions. It is interesting how the diversion tends to affect the water quality along the shore of Mississippi Sound, where the influence beyond the barrier islands can not be detected from the plots, except

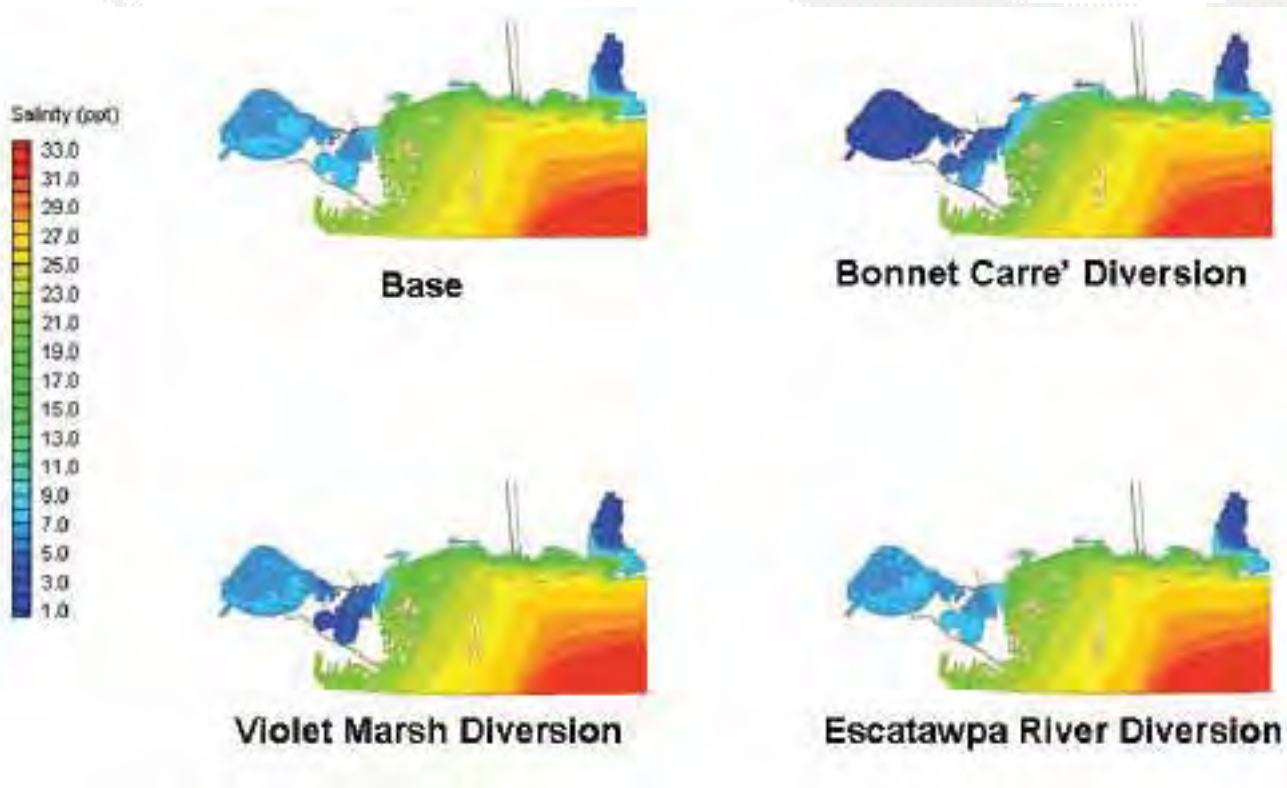

Figure 6. Summer average surface concentration contours for salinity for three conditions.

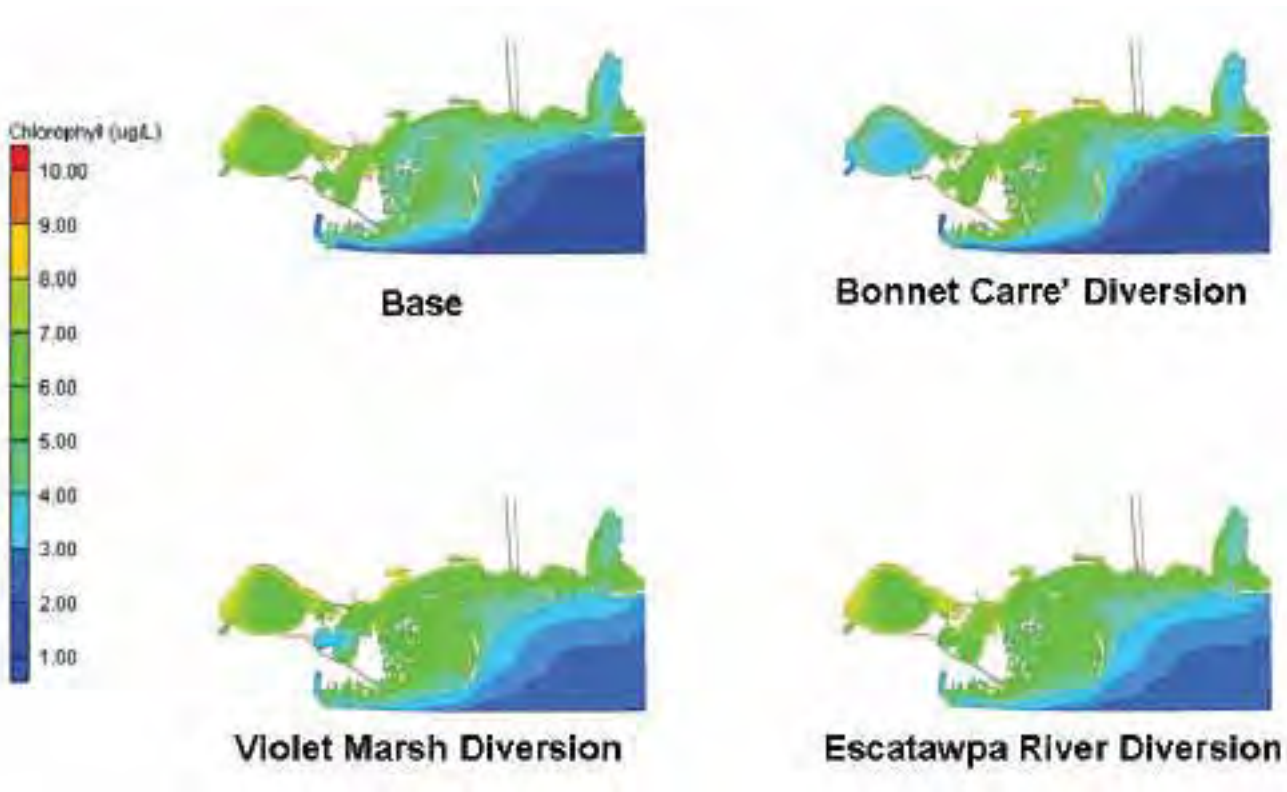

Figure 7. Summer average surface concentration contours for chlorophyll for three conditions

SURFACE WATER QUALITY

for possibly chlorophyll. The diversion has a fairly significant influence all along the coast from Lake Borgne to Mobile Bay. There is also an influence within the Mississippi River Gulf Outlet and where it empties north of Breton sound.

Similar to the Bonnet Carre' diversion, the effects of the Violet Marsh diversion are very apparent in the western portion the domain, whereas, in other parts of the domain, the changes are not as obvious unless one looks closely at the near shore conditions. The diversion tends to affect the water quality along the shore of Mississippi Sound, whereas the influence beyond the barrier islands can not be detected from the plots, except for possibly chlorophyll. This diversion elevates chlorophyll near the Chandeleur Islands, more so than the Bonnet Carre' diversion. The diversion influences water quality all along the coast from Lake Borgne to Mobile Bay, but not as much as the Bonnet Carre' diversion.

The summer average concentration contours also show that there is little, if any, difference in the results for the Escatawpa diversion and base conditions. The changes in water quality are limited to Grand Bay and the Mississippi shoreline west of Grand Bay. It is interesting how this diversion has any impact within Bay St. Louis although the impact is small. Salinity is decreased a few parts per thousand in Grand Bay and westward along the coast. Chlorophyll is increased slightly (less than 1 µg/L), as well as TSS (about 1 mg/L) in the same areas. Little to no change in light extinction occurred.

Conclusion

This model study indicates that freshwater diversions from the Mississippi River through either Bonnet Carre' Spillway or Violet Marsh will result in substantial changes in water quality. The effect of freshwater diversions are expected to be felt throughout much of the area along the coast even for relatively modest diversions (7500 cfs) introduced on the edges of the system (such as Violet Marsh). The changes in Mississippi Sound water quality resulting from these diversions will include lower salinity, higher concentrations of nutrients, TSS, phytoplankton, and TOC, and greater light extinction, thus, less light reaching the bottom. The latter change could impact SAV densities.

Figures 6 through 9 show the amount of change relative to the existing base conditions. In some cases, the change is quite dramatic. However, it is emphasized that the amount of water diverted can make a great difference. The amount of change for each diversion is directly proportional the amount of water diverted. Thus, the Bonnet Carre' diversion had a greater effect than the Violet Marsh diversion since the flows were greater for the former. Similarly, the Violet Marsh diversion had a much great difference than the Escatawpa River diversion for the same reason. The flows of the Escatawpa River were so low during April through September of 1998, that this diversion had little impact except within Grand Bay, where changes were relatively small and mostly confined near shore.

As with many model studies, results presented here should be treated as relative, rather than absolute forecasts. Thus, the water quality for diversions should be compared relative to the base conditions, rather than used as refined forecasts of future concentrations. This is particularly true for salinity and TSS since these two constituents of interest presented calibration challenges. A more detailed analysis with additional calibration work is expected to improve the accuracy of salinity predictions. Improving the accuracy of TSS predictions is more problematic given the paucity of data and lack of full understanding of processes affecting TSS in this system. Model enhancements and more detailed study would be required to refine the accuracy of the water quality model for forecasting absolute water quality conditions with diversions. Such refinement of the model should be considered if the MSCIP proceeds with more definitive plans for diversions.

Results from the water quality model can still be used to estimate changes in habitat for living resources of interest. The best approach with the present model is to delineate the areas that exhibit the water quality conditions required for acceptable habitat using model output for base conditions. Model output for alternative diversions can then be used to delineate areas of acceptable habitat with diversion. The areas where acceptable habitat has changed (gained or lost) can then be determined and shown. This approach is based on relative changes in water quality rather than absolute results.

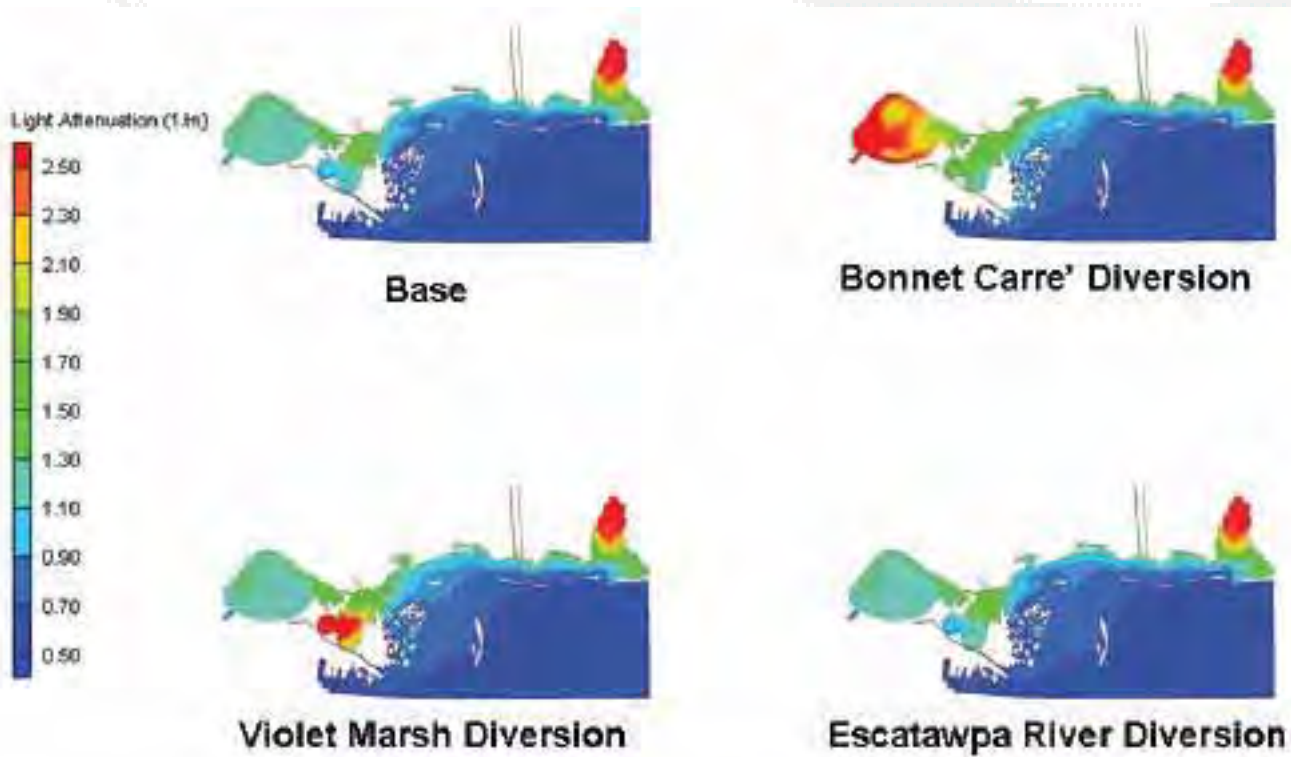

Figure 8. Summer average light extinction for three conditions.

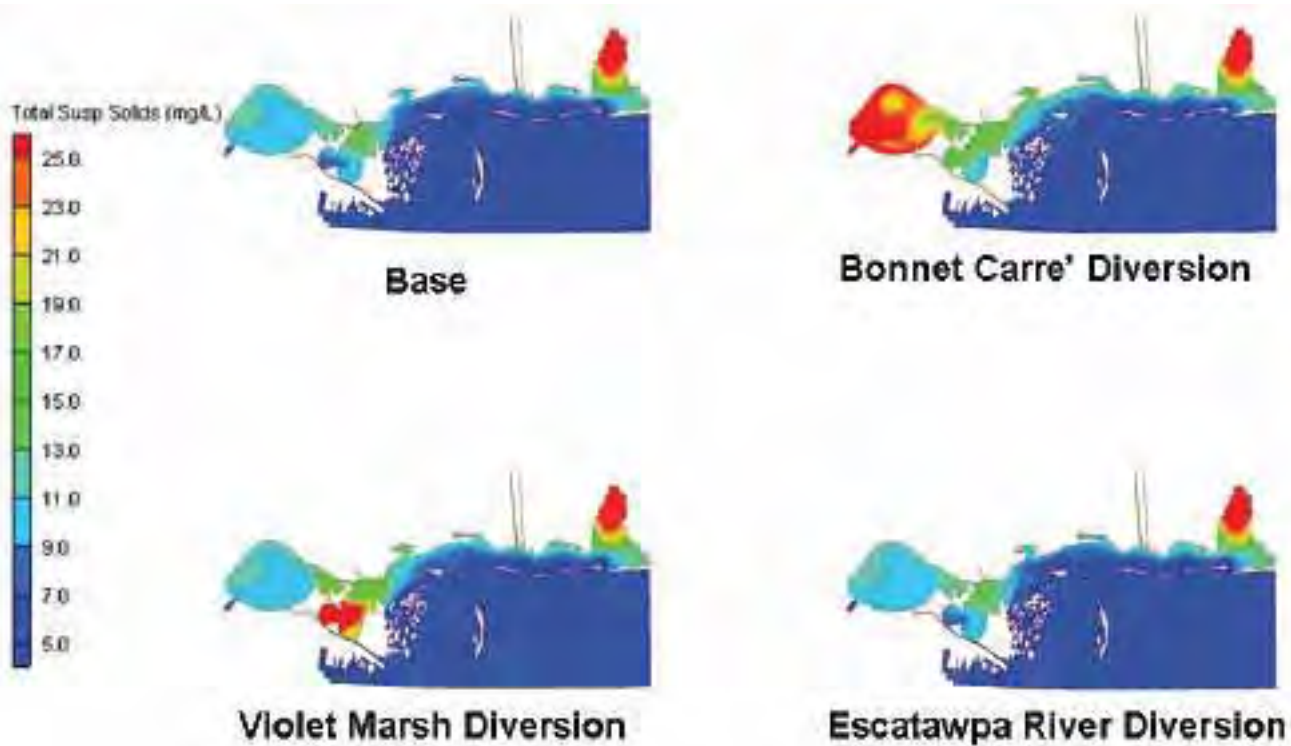

Figure 9. Summer average surface concentration contours for TSS for three conditions

SURFACE WATER QUALITY

References

- Bunch, B., Cerco, C., Dortch, M., Johnson, B., and Kim, K. (2000). "Hydrodynamic and water quality model study of San Juan Bay and Estuary," ERDC TR-00-1, U.S. Army Engineer Research and Development Center, Vicksburg MS.
- Bunch, B.W., Channell, M., Corson, W.D., Ebersole, B.A., Lin, L., Mark, D.J., McKinney, J.P., Pranger, S.A., Schroeder, P.R., Smith, S.J., Tillman, D.H., Tracy, B.H., Tubman, M.W., and Welp, T.L. (2003). "Evaluation of Island and Nearshore Confined Disposal Facility Alternatives, Pascagoula River Harbor Dredged Material Management Plan," ERDC TR-03-3, U.S. Army Engineer Research and Development Center, Vicksburg, MS.
- Bunch, B.W., Chapman, R.S., Ebersole, B.A., Luong, P.V., Mark, D.J., McKinney, J.P., Tillman, D.H., and Webb, D.W. (2005). "Evaluation of Proposed Improvements to the Gulfport Harbor, Mississippi, Navigation Channel," ERDC/CHL/EL TR-05-XX, Draft technical report for the U.S. Army Engineer District, Mobile by the U.S. Army Engineer Research and Development Center, Vicksburg, MS.
- Cerco, C.F. and T. Cole. (1993). "Three-dimensional eutrophication model of Chesapeake Bay," *J. Environmental Engineering*, 119(6):1006-1025.
- Cerco, C.F. Bunch, B., Cialone, M.A., Wand, H. (1994). Hydrodynamics and Eutrophication Model Study of Indian River and Rehoboth Bay, Delaware. Prepared for the U.S. EPA, Delaware Department of Natural Resources and Environmental Control and U.S. Army Engineer District, Philadelphia, Technical Report EL-94-5.
- Cerco, C. and Bunch, B. (1997). "Passaic River tunnel diversion model study, Report 5, water quality modeling," Technical Report HL-96-2, U.S. Army Engineer Waterways Experiment Station, Vicksburg, MS.
- Cerco, C.F., Bunch, B.W., Teeter, A.M., and Dortch, M.S. (2000). "Water Quality Model of Florida Bay," ERDC/EL TR-00-10, U.S. Army Engineer Research and Development Center, Vicksburg, MS.
- Cerco, C. F., Bunch, B., Dortch, M., Johnson, B. H., and Kim, K. (2003). "Eutrophication and Pathogen Abatement in San Juan Bay Estuary," *Journal of Environmental Engineering*, Vol. 129, No. 4, American Society of Civil Engineers, pp.318-327.
- Cerco, C.F., Noel, M.R., and Kim, S.C. (2004). "Three-Dimensional Eutrophication Model of Lake Washington, Washington State," ERDC/EL TR-04-12, U.S. Army Engineer Research and Development Center, Vicksburg, MS.
- Chapman, R.S., Johnson, B.H., and Vemulakonda, S.R. (1996). "Users Guide for the Sigma Stretched Version of CH3D-WES; A Three-Dimensional Numerical Hydrodynamic, Salinity and Temperature Model," Technical Report HL-96-21, U.S. Army Engineer Waterways Experiment Station, Vicksburg, MS.
- Dortch, M. S., M. Zakikhani, M. Noel, and Sung-Chan Kim (2007). Application of a Water Quality Model to Mississippi Sound to Evaluate Impacts of Freshwater Diversions Technical Report EL-XX-X, U.S. Army Engineer Waterways Experiment Station, Vicksburg, MS.
- Edinger, J., Brady, D., and Geyer, J. (1974). "Heat exchange and transport in the environment," Report 14, Department of Geography and Environmental Engineering, John Hopkins University, Baltimore, MD.
- Goolsby, D.A., Battaglin, W.A., Lawrence, G.B., Artz, R.S., Aulenbach, B.T., Hooper, R.P., Keeney, D.R., and Stensland, G.J. (1999). "Flux and sources of nutrients in the Mississippi-Atchafalaya River Basin, Topic 3 report for the integrated assessment on hypoxia in the Gulf of Mexico," NOAA Coastal Ocean Program, Decision analysis series No. 7.
- Penland, S, Beall, A., and Kindinger, J. eds. (2002). "Environmental Atlas of the Lake Pontchartrain Basin," USGS

SURFACE WATER QUALITY

Water Quality Modeling in Support of the Mississippi Sound Coastal Improvement Program
Zakikhani, et al

Open File Report 01-206, <http://pubs.usgs.gov/of/2002/of02-206/>

Tillman, D.H., Cerco, C.F., Noel, M.R., Martin, J.L., and Hamrick, J. (2004). "Three-Dimensional Eutrophication Model of the Lower St. Johns River, Florida," ERDC/EL TR-04-13, U.S. Army Engineer Research and Development Center, Vicksburg, MS.

SURFACE WATER QUALITY

Mississippi Benthic Macroinvertebrate Tolerance Values for Use in Surface Water Quality Assessment

Matthew Hicks, David W. Bressler, James B. Stribling, and Michael J. Paul
Mississippi Museum of Natural Science
2148 Riverside Drive
Jackson, MS, 39202
601.354.7303
E-mail: matt.hicks@mmns.state.ms.us

ABSTRACT

Conceptually, tolerance values are meant to represent the ability of aquatic organisms to survive in the presence of known levels of various types of water quality pollution. Operationally, they describe the relative abundance and co-location of organisms and pollutants. These numeric values are used to calculate assemblage level tolerance metrics that are commonly incorporated into indices of biological integrity. Defensibility of water quality assessments using tolerance value metrics depends, in part, on how individual tolerance values are developed. We derived tolerance values using an approach that attempted to minimize subjective circularity and maximize objectivity, by using abiotic characteristics of aquatic ecosystems to define gradients of water quality. Also, because most cases of water quality impairment involve multiple stressors at various levels in a given system, we used an approach that combines multiple physical and chemical characteristics into a single general stressor gradient. In this paper, we describe the development of tolerance values for benthic macroinvertebrate taxa collected from 455 wadeable stream sites throughout Mississippi, except the Mississippi Alluvial Plain (Mississippi River Delta). Principal components analysis (PCA) was used to develop a gradient that incorporated direct (in-stream physical and chemical) and indirect (land use) stressors, which was then scaled from 0-10. Weighted averaging of the relative abundance of each taxon was used to assign tolerance values based on the point of greatest relative abundance along the stressor gradient. Tolerance values were derived for 324 of the 567 taxa collected from across all sites, and primarily represented sensitivity to habitat, sediment loading and hydrologic alteration, and increased nutrient concentrations. We suggest that this approach could be used in other areas of the country to develop new tolerance values or refine existing ones, and may be a useful approach for other taxonomic groups.

Keywords: Surface Water, Water Quality, Ecology, Methods



FLOODING AND WATER SUPPLY

Mapping Hurricane Katrina Peak Storm Surge in Alabama, Mississippi, and Louisiana

D. Phil Turnipseed and K. Van Wilson, Jr.
USGS Mississippi Water Science Center

National Weather Service Expansion of Hydrologic Services in Mississippi

David B. Reed
NWS Lower Mississippi River Forecast Center

Supply and Demand: The Effects of Development on the Hydrology of Lake Victoria

Phillip A. Songa and Sowed M. Sewagudde
Admiral House and Water Resources Management Department, Uganda

The Geology of Ground Water in Mississippi Revised

David T. Dockery
Mississippi Office of Geology, Mississippi Department of Environmental Quality

FLOODING AND WATER SUPPLY

Mapping Hurricane Katrina Peak Storm Surge in Alabama, Mississippi, and Louisiana

D. Phil Turnipseed, K. Van Wilson, Jr., Jason Stoker, and Dean Tyler
USGS Mississippi Water Science Center
308 South Airport Road
Jackson, MS 39208-6649
601-933-2922
E-mail: kvwilson@usgs.gov

ABSTRACT

Hurricane Katrina produced the largest peak storm surge observed in the Gulf of Mexico. Hurricane Katrina made land-fall on the northern Gulf of Mexico Coast early on August 29, 2005, first slamming into the Mississippi River delta near Buras, Louisiana, and then overwhelming the Pearl River delta at the Louisiana-Mississippi border. Riverine flooding from Katrina-induced rainfall was minimal in the region, but the storm devastated the Gulf of Mexico coastal region of southeastern Louisiana, Mississippi, and Alabama. Katrina has been estimated to have caused the loss of more than 1,800 human lives, and about \$81 billion in damages.

In the wake of Katrina's destruction, high water marks—representing Katrina's peak storm surge—were flagged, surveyed, and documented by teams representing the Federal Emergency Management Agency, the U.S. Geological Survey, U.S. Army Corps of Engineers, and others. Peak storm surge of about 29 feet was documented near Bay St. Louis, Mississippi, confirming that Katrina was more than 4 feet greater than Hurricane Camille (previous largest known peak storm surge).

In the months that followed, the U.S. Geological Survey began developing an internet-based geographic information system (GIS) application that will allow a user to pinpoint depths of the Hurricane Katrina peak storm surge in the affected states. Pre-Katrina flown Light Detection and Ranging (LiDAR) data were seamlessly conjugated to form a high-resolution digital elevation model (DEM) that served as the base for the mapping. The Federal Emergency Management Agency also contributed pre-Katrina LiDAR-based DEMs and inundation polygons, and high water marks for Louisiana, Mississippi, and Alabama. These data were supplemented by available U.S. Geological Survey, U.S. Army Corps of Engineers, and Interagency Performance Evaluation Task Force tide gage and high water mark data to compile high water elevations at more than 1,500 locations to be used in generating a peak storm surge GIS coverage for the affected coastal region. In addition, the U.S. Geological Survey Earth Resources Observation and Science Center obtained U.S. Army Corps of Engineers Mobile District post-Katrina LiDAR for further use in computing planform changes of barrier islands/coastlines in the region and developing methods to estimate debris volume caused by the storm.

Keywords: Floods, Hydrology, Surface Water, Wetlands, Methods

FLOODING AND WATER SUPPLY

History of Hurricane Katrina

In the late evening of August 25, 2005, less than 2 hours before Tropical Storm Katrina made first landfall on the southeastern Atlantic coast of Florida, the storm was upgraded to a Category 1 (Saffir-Simpson Hurricane Scale) hurricane after forming as a tropical depression over the Bahamas on August 19. After spending only 6 hours over land in southern Florida, Tropical Storm Katrina reentered open water in the southeastern Gulf of Mexico in the early morning of August 26, just north of Cape Sable. Throughout the next 3 days, Katrina rapidly intensified from a tropical storm to a Category 5 Hurricane with a maximum peak wind speed intensity of greater than 170 miles per hour (mph) late in the afternoon of August 28. This maximum intensity occurred about 170 nautical miles southeast of the mouth of the Mississippi River and helps explain the extreme proportions of the storm surge height that occurred from Hurricane Katrina when it made landfall. During Katrina's maximum intensity, tropical storm and hurricane force winds extended 200 and 90 nautical miles from the eye, respectively (Knabb and others 2005). These conditions defined Hurricane Katrina as one of the most intense and largest storms to ever form in the northern region of the Gulf of Mexico.

After some erosion of the eye wall late on August 28, Hurricane Katrina turned northward to make landfall near Buras, Louisiana, about 1110 Universal Time Coordinated (UTC) with about 125 mph sustained winds, making the storm a strong Category 3. Katrina then continued northward, briefly reentering the Gulf of Mexico before making final landfall near the mouth of the Pearl River at the Louisiana-Mississippi boundary as a very dangerous Category 3 storm with an estimated intensity of 120 mph sustained winds. Knabb and others (2005) explained that although Hurricane Katrina had weakened from a Category 5 to a Category 3 in approximately the last 18 hours before landfall, the radial extent of tropical storm and hurricane force winds remained about the same, which helps explain the extreme storm surge in southeastern Louisiana and the Mississippi Gulf Coastal region.

Katrina weakened rapidly after its final landfall near the Louisiana-Mississippi border, becoming a Category 1 storm

by 1800 UTC on August 29 in central Mississippi, and was then downgraded to a tropical storm early on August 30, after only 5 days as a hurricane in the Gulf of Mexico.

Study Area Description

Alabama, Mississippi, and Louisiana are located within the East Gulf Coastal Plain physiographic province; the Hurricane Katrina storm surge-affected region (fig. 1) generally is within 30 miles of the Gulf of Mexico coast. Land-surface elevations in the affected region range from sea level near the coast to more than 50 feet above sea level. The climate varies from humid to sub-tropical. Average annual rainfall is almost 70 inches near the coast (Wax, 1990).

Objectives

This paper describes the methods used in the development of a Web-based geographic information system (GIS) mapping application that allows users to pinpoint maximum storm surge depths across regions of Alabama, Mississippi, and Louisiana affected by Gulf flooding from Hurricane Katrina and presents examples of provisional results of this mapping project. The paper also discusses the development of the digital elevation model (DEM) derived from pre-Katrina acquired LiDAR for this coastal region. The paper does not present the extent or magnitude of subsequent flooding of the metropolitan area of New Orleans, La., caused by breaches and breaks of the levee system that occurred after the initial Hurricane Katrina storm surge passed. The data presented in this paper are provisional and subject to change upon further review by the USGS.

Methods

LiDAR Data Processing

Immediately following Hurricane Katrina, the USGS Earth Resources Observations and Science (EROS) Data Center began the detailed task of processing pre-Katrina LiDAR data for Baldwin and Mobile Counties in Alabama, for Jackson, Hancock, and Harrison Counties in Mississippi, and for the eastern parishes in Louisiana. Data were obtained from multiple sources, including a private company, and local, State, and Federal entities [such as the National



Figure 1. Map of the coastal region of Louisiana, Mississippi, and Alabama affected by Hurricane Katrina.

Oceanic and Atmospheric Administration (NOAA)] and were developed for varying purposes and in accordance with differing criteria designed to meet the needs of the end use of the agency or entity contracting for the collection of the data. Because the data were collected independently in various file formats, projections, and levels of processing, the task of producing a seamless digital elevation dataset required a high level of research, coordination, and revision. Many technical issues were resolved before EROS was able to produce the seamless digital elevation dataset (1/9th arc-second (3-meter) grid) used as the map base for projecting the Katrina peak storm surge in the affected coastal region.

After the data were seamlessly integrated, a shaded-relief image was created and used for quality assurance and quality control of the processing methods. Initial quality-assurance checks revealed that a few tiles needed to be reprocessed, and some differences in Geoid projections used were detected and corrected. After the data were initially quality assured, the datasets were finalized in ArcSDE to be used in the Web-based mapping application.

After the 0.5 x 0.5 degree grids (ArcGIS GRID format) were generated via the ASSEMBLE program, the z-values (elevation data) were converted from meters to feet. Map projections were defined for each grid to reduce error messages

FLOODING AND WATER SUPPLY

in subsequent ArcGIS processing. The tiled grids were then merged into county-based grids. The shaded relief grids for each county were also merged into county-based grids.

ArcGIS/IMS relies on the use of pre-generated pyramid raster grids to reduce display times for very large images. Unfortunately, the ArcGIS internal resampling method does not create pyramids from shaded relief layers that are optimized for visualization. Therefore, EROS created custom pyramid layers and used those for displaying in ArcGIS/IMS. This was accomplished by resampling the full-resolution LiDAR layer using bilinear interpolation to create elevation layers that have cell sizes in multiples of 2. Shaded relief grids were then generated from each of the custom pyramid layers. These custom pyramid layers are made visible in the Web-based mapping application by using minimum and maximum scale viewing thresholds.

A mosaic of the elevation grids for all five counties and for eastern Louisiana was then created. Loading the elevation grid data to ArcSDE resulted in a 31.5 GB GIS layer. Further pyramid layering was done, and then statistics for the datasets were computed. All elevations are in feet above North American Vertical Datum of 1988 (NAVD88).

Many technical issues were encountered and solved as necessary. For example, the various Windows/ArcGIS temporary directory variables had to be set large enough to avoid running out of disk space during processing. Another example requiring a "work-a-round" was discovered when increasing the size of the study area. Theoretically, preferably, logically, and historically, when performing this operation with ArcInfo, any new pixels in a larger geographic window for which there are no input values would be set to NODATA. In ArcGIS, however, these pixels are assigned a value of zero, necessitating further intermediate processing to eliminate the division operand errors involved in computing datasets with zero.

Peak Storm Surge Elevation

Almost immediately after the landfall of Hurricane Katrina, survey crews from the USGS, FEMA, USACE and others were dispatched to flag, survey, and document the peak storm surge caused by the storm. FEMA contributed

inundation polygons and high-water marks for Alabama, Mississippi, and Louisiana. These data were supplemented by available USGS, USACE, and Interagency Performance Evaluation Task Force tidal gage and high-water mark data to compile high-water elevations at more than 1,500 locations. These data were processed further, filtered, and eventually 842 high-water marks were used to generate the peak storm surge GIS coverage for the affected coastal region (figure 2). The storm surge coverage was generated using the spline with barrier algorithm in ArcGIS. The barriers used were selected levees and basin divides to better attenuate the surge as it moved inland into the back bays and estuaries (figure 2). The mapping was for areas outside the New Orleans, La., levees to approximate the peak storm surge that approached the levees. This storm surge coverage was then carefully overlaid and fitted to the LiDAR DEM of the region by using the ArcGIS raster calculator to determine flooded and non-flooded areas. The flooded area polygon was used to define the inundation boundaries, which were then used to clip the peak storm surge surface as shown in figure 2. All elevations are in feet above North American Vertical Datum of 1988 (NAVD88).

Peak storm surge elevations of greater than 29 feet were documented near Bay St. Louis, Miss., confirming that the Katrina storm surge was more than 4 feet greater than storm surge caused by Hurricane Camille (highest known peak storm surge to hit the region prior to Hurricane Katrina).

Web-based Mapping Application Development

The Web mapping application for the Katrina-affected coastal region of the Gulf of Mexico in Alabama, Mississippi, and Louisiana was developed based on Open Geospatial Consortium, Inc. Web Map Service (OGC/WMS) ArcIMS technology, accessing vector and raster layers stored in ArcSDE. This technology is an industry standard for serving GIS data to the Internet. The following paragraphs outline the methods used in creating the Web-based mapping application.

One of the major advantages to using the WMS approach is a tool that allows collapsing groups of layers - particularly helpful when dealing with large numbers of layers.

Another advantage is the option of using the transparency characteristic of Graphic Information Files (gifs); for example, the amount of transparency for layers such as the color Katrina storm surge surface can be easily adjusted.

There are currently four tools on the website:

- 1) Elevation Query Tool, which uses the USGS National Elevation Dataset (NED) 1/3rd arc-second grid data as the elevation source,
- 2) Gulf Elevation Query Tool, which returns the elevation of a point for both the LiDAR elevation and the storm surge surface,
- 3) U.S. National Grid Query Tool, which returns the

National Grid coordinates for a specified point, and
4) Profile Comparison Tool, which displays a graph or text listing of the profile points for any two of the four source elevation layers.

The use of trade or product names is for identification purposes only and does not constitute endorsement by the U.S. Government.

Summary

The USGS, in cooperation with several other Federal, State, and local agencies, completed development of a Web-based geographic information system (GIS) mapping

Hurricane Katrina Peak Storm Surge Inundation Mapping

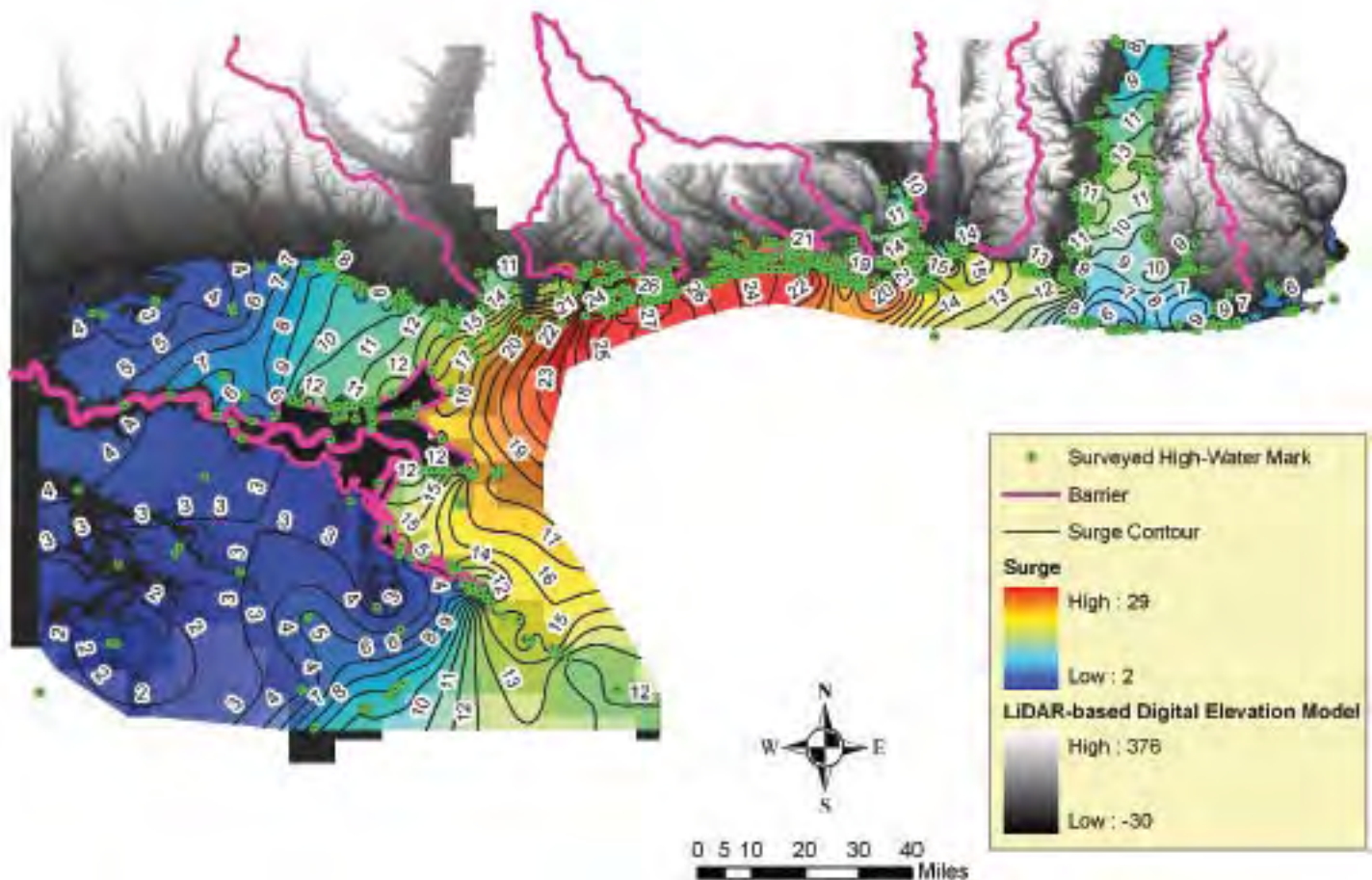

Figure 2. Peak storm surge inundation map generated from 842 surveyed high-water marks and LiDAR-based Digital Elevation Model.

FLOODING AND WATER SUPPLY

application to allow a given user to pinpoint depths of the Hurricane Katrina peak storm surge in the storm-affected States of Alabama, Mississippi, and Louisiana. Pre-Katrina flown Light Detection and Ranging (LiDAR) data were seamlessly integrated to form a high-resolution digital elevation model (DEM) that served as the base for the mapping.

References

- Bales, J.D., Oblinger, C.J., and Sallenger, A.H., Jr., 2000, Two months of floodings in eastern North Carolina, September-October 1999: hydrologic, water quality, and geologic effects of Hurricanes Dennis, Floyd, and Irene: U.S. Geological Survey Water-Resources Investigations Report, 47 p.
- Knabb, R.D., Rhome, J.R., and Brown, D.P., 2005, Tropical Cyclone Report: Hurricane Katrina 23-30 August 2005: NOAA National Hurricane Center, December 20, 2005, 43p.
- Sallenger, A. H., Jr., and Brock, J.C., 2001, Coastal change hazards during extreme storm investigated with airborne topographic LiDAR: U.S. Geological Survey Open File Report, 2 p.
- Turnipseed, D. Phil., Gerald L. Giese, J. Leroy Pearman, Gaye S. Farris, M. Dennis Krohn, and Asbury H. Sallenger, Jr., 1998, Hurricane Georges: Headwater flooding, storm surge, beach erosion and habitat destruction on the Central Gulf Coast: U.S. Geological Survey Water-Resources Investigations Report 98-4231.
- Wax, Charles L. 1990. General Climatology of Mississippi-Floods and Droughts, Chapter in National Water Summary 1988-Hydrologic Events and Floods and Droughts. Reston, VA: USGS Water Supply Paper 2375.
- Wilson, K.V., Sr., and Hudson, J.W., 1969, Hurricane Camille tidal floods of August 1969 along the Gulf Coast: U.S. Geological Survey Hydrologic Investigations Atlases HA-395 to HA-408.

FLOODING AND WATER SUPPLY

National Weather Service Expansion of Hydrologic Services in Mississippi

David B. Reed
NWS Lower Mississippi River Forecast Center
62300 Airport Road
Slidell, LA 70460
985-641-4343
E-mail: Dave.Reed@noaa.gov

ABSTRACT

The National Weather Service is expanding and modernizing hydrologic services in the state of Mississippi. The NWS is developing a modeling system for the coastal areas that links our current hydrologic models with hydraulic and oceans models to provide better forecasts. Flood inundation maps will be developed to provide emergency managers information on areas that will be flooded at specific river levels. Enhanced modeling procedures will be tested at selected locations within the state.

As a pilot project on the Pascagoula River, the NWS is developing a hydrodynamic model simulating the water levels in the Gulf of Mexico and a 2-dimensional hydraulic model for the Pascagoula River drainage below Merrill, MS. These models will be linked to the NWS hydrologic model resulting in model simulations for this area that incorporate the effects of riverine flooding and the effects of tides and storm surge from hurricanes. This system should allow the NWS to provide more accurate forecast at existing sites and easily implement forecasts at additional sites.

For selected locations in Mississippi, flood inundation maps will be prepared. At one-foot intervals from flood stage to the flood of record, a hydraulic model will be run to determine the water surface elevations for a steady state flow condition. From these elevations using geographic information systems (GIS) technologies, maps depicting flood inundation areas will be developed. These maps will be provided to local and state emergency managers for use in determining evacuation areas.

As a test, the NWS will implement additional enhanced hydrologic modeling procedures. For small watersheds, the Sacramento Soil Moisture Accounting Model will be tested on an hourly time step. A distributed hydrologic model will be calibrated and tested on a small watershed in Mississippi. In addition to model development, the NWS will conduct outreach and training with local emergency managers and officials on these new and improved techniques.

Keywords: Floods, Hydrology, Models

Introduction

The National Weather Service is responsible for preparing and issuing river and flood forecasts and warnings to mitigate the loss of life and property. NWS hydrologic forecasts and services are used by decision makers such as emergency managers and water resources managers. Those decisions range from evacuations to save lives and property to optimizing water usage for power and water supply. The NWS is modernizing the science used in their forecasting

and as a result new products are being developed for the state of Mississippi.

To provide enhanced forecasts for the Pascagoula River, the NWS is developing a 2-dimensional hydraulic model of that river and linking it to an ocean model which simulates the changes in water elevation due to winds, tides, and storm surge. To provide emergency managers more information on flood evacuations, flood inundation maps are being developed for several locations throughout the state. A distributed

FLOODING AND WATER SUPPLY

hydrologic model using digital elevation data and gridded inputs will be tested at selected locations in Mississippi.

Current Hydrologic Services in Mississippi

Currently, the NWS provides river and flood forecasts for 70 locations in Mississippi as shown in Figure 1. At these locations, the NWS provides forecasted river levels for the next 5 days in 6-hour increments. These forecasts are disseminated daily and are based on the rain that has already fallen plus the expected or forecasted rainfall for up to the next 24 hours. These forecasts are prepared by the Lower Mississippi River Forecast Center (LMRFC) and Southeast River Forecast Center (SERFC) as indicated in Figure 1. To prepare these forecasts, the RFCs model the soil moisture and estimate runoff using the Sacramento Soil Moisture Accounting Model (SACSMA). Unit hydrographs are utilized to convert the runoff depth to flow at the basin outlet, and Variable Lag and K routing is used to route the water downstream. Rating curves from the USGS are used to convert stages to flows. For the Mississippi River, the FLDWAV hydraulic model is run to simulate the complex hydraulic conditions on the river. Inputs into the FLDWAV model include observed and forecasted flows from the Ohio River at Smithland Lock and Dam, IL, and the Mississippi River at Chester, IL.

River Forecast Centers serve as regional centers by providing hydrologic modeling expertise. The forecasts prepared by the LMRFC and SERFC are provided to the Weather Forecast Offices (WFO). The WFOs coordinate the effects of these forecasts with local government officials and the media and issue products on NOAA Weather Radio. WFO responsibilities in Mississippi are delineated in Figure 1.

Forecasting river stages is a collaborative effort between the NWS and other federal, state and local agencies. The NWS relies heavily on the US Geological Survey (USGS) for real-time data collection and rating curves to convert stages to flows. The US Army Corps of Engineers (COE) operates flood control structures needed by RFCs to provide forecasts downstream. RFCs coordinate closely with reservoir operators to factor observed and planned flows into downstream forecasts. Some state agencies operate reservoirs and the

RFCs must work closely with them on reservoir operations.

New Products and Services

The NWS is in the middle of a multi-year project called Advanced Hydrologic Prediction Services (AHPS) to modernize and expand their products and services. As a result of Hurricane Katrina, increased emphasis has been placed on forecasting of water/river levels in the Gulf Coast states. As a result, a significant amount of effort will be placed on developing procedures to improve and expand hydrologic forecast services. Once those procedures have been proven their effectiveness, they will be used as a guide to improve services at additional locations as time and money permits.

Advanced Hydrologic Prediction Services (AHPS) - In AHPS, the NWS is working to improve and modernize hydrologic services through several major initiatives. These initiatives are focused on improving the current science used, taking advantage of new web technology and dissemination methods, developing new science and techniques, and implementing probabilistic forecasts.

To improve the existing science used in our models, RFCs are recalibrating the Sacramento Soil Moisture Accounting Model (SACSMA) for all of their current forecast system. This work is a combination of RFC staff time and efforts of contractors. This major effort was started in the LMRFC area in 2002 and is expected to last through about 2013. The precise date for the completion of all the recalibrations is uncertain because it is tied to available budget.

Concurrent with recalibrating the hydrologic models, the NWS has implemented a standard web portal to make forecasts available to our customers much easier. All NWS hydrologic forecasts are available at <http://www.weather.gov/ahps/>. Efforts are underway to make our websites more reliable with redundant servers at three locations and load balancing to point users to the server with the least workload.

The NWS is investing in the development of new science. Current RFCs run the SACSMA lumped hydrologic model on a 6-hour timestep. Basin sizes range from 50-800 square miles. Basin average rainfall for a 6-hour period is the primary input into these models. To compute 6-hour mean areal precipitation used in the SACSMA, hourly gridded estimates

FLOODING AND WATER SUPPLY

National Weather Service Expansion of Hydrologic Services in Mississippi
Reed

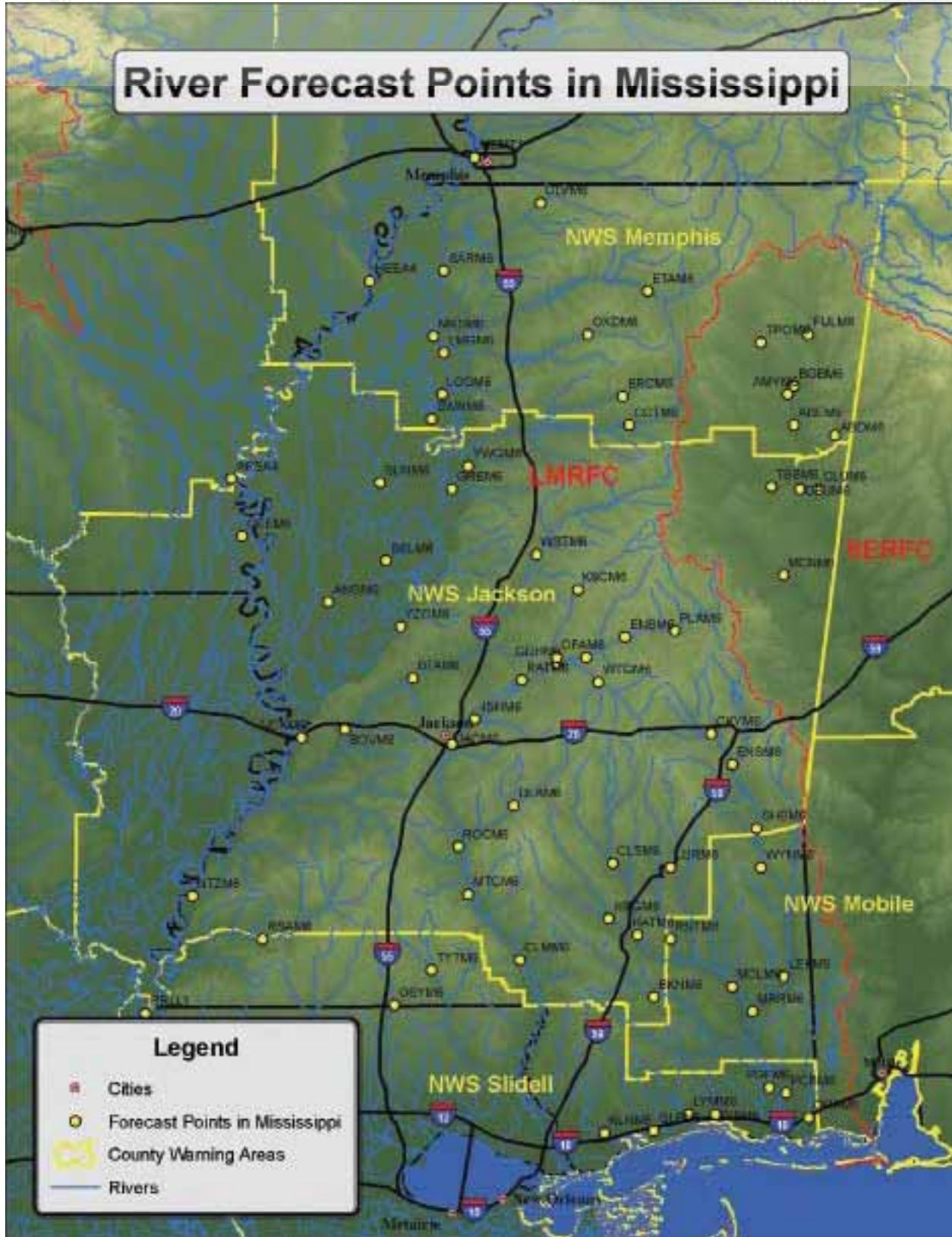

Figure 1. NWS Hydrologic Forecast Services in Mississippi.

FLOODING AND WATER SUPPLY

of precipitation from the WSR-88D weather radar are averaged over the basin. These hourly basin averages are then summed to provide the necessary input into LMRFC forecast models. To make maximum use of the gridded rainfall on an hourly basis, the NWS has developed the Hydrology Laboratory Research Distributed Hydrologic Model (HL-RDHM) and is working to implement it at selected sites for evaluation and testing. Using the HRAP grid system as a basis (approximately a 4kmx4km grid), the HL-RDHM performs soil moisture accounting at each grid location using a modified SACSMA model on an hourly basis. Kinematic techniques will be used the route the water from one grid point to another until it reaches the basin outlet. The next step in development is to utilize remote-sensed data (satellite and radar) to develop a physically based distributed model.

To provide more information to our users, the NWS is implementing probabilistic forecasts. As model calibration is complete at a site, probabilistic forecasts for the next 90 days are provided. A sample of our probabilistic products is shown in Figure 2. This graph shows the likelihood of the river location reaching a specific level in the next 90 days. These probabilistic forecasts are based on current soil moisture conditions and historical precipitation data. LMRFC has implemented long-term probabilistic forecasts at several locations in northern Mississippi and expects to provide such forecasts at all locations in Mississippi by the end of 2008.

The NWS is also experimenting with short-term probability forecasts. In addition to our current deterministic forecasts, we would provide probabilities of the river reaching a specific level. A sample of how this forecast might look is shown in Figure 4. This would provide our users an indicator of the uncertainty or confidence we have in our forecasts. Two pilot projects are currently underway to develop short-term probability forecasts. Short-term probability forecasts will likely not be implemented across the country for several more years.

Pascagoula River Modeling

Historically, the NWS modeled the interface between riverine flooding and flooding from storm surge and high tides at very few locations. At this interface, subjective techniques

have been employed to provide forecasts which rely heavily on RFC forecaster expertise and knowledge.

As a result of Hurricane Katrina, a modeling system is being developed to link the current RFC riverine forecast models with hydrodynamic ocean models. The University of Central Florida (UCF) is developing the Advanced Circulation Model (ADCIRC), a finite element hydrodynamic model, to simulate water elevations in the Gulf of Mexico, the Caribbean, and western half of the Atlantic Ocean. UCF will then develop the ADCIRC model for the Pascagoula River below Merrill in a finer mesh. Downstream boundary conditions for the fine mesh ADCIRC model will be obtained from the larger scale model run. Upstream boundary conditions will be the locations where the LMRFC performs hydrologic model simulations as shown in Figure 4. In addition to UCF developing the ADCIRC model of the Pascagoula, LMRFC will develop the HEC-RAS model, a 1-dimensional hydraulic model. Results of the 2-dimensional ADCIRC runs and the 1-dimensional HEC-RAS runs will be compared. The NWS will have access to ADCIRC model output during landfalling tropical systems. Computer hardware requirements will be determined to run ADCIRC operationally at a River Forecast Center.

Inundation Mapping

Emergency managers have repeatedly called for inundation maps to delineate areas of flooding based on a specific river stage. Through a contractor, flood inundation maps will be developed for five (5) locations in Mississippi as a proof of concept. The contractor will utilize LIDAR data and available cross-sectional data used in developing FEMA Flood Inundation Rate Maps (FIRMs) to compute the water surface profile for water levels at 1-foot increments above flood stage. This catalog of inundation maps will be provided to emergency managers to support evacuation efforts.

The NWS is developing a website to serve up these images and data can be downloaded from the server and imported into a GIS. The NWS is evaluating the availability of data for selected sites to determine the optimum locations to develop these maps. As resources and money permits, these maps will be developed for the rest of the state. The

FLOODING AND WATER SUPPLY

National Weather Service Expansion of Hydrologic Services in Mississippi
Reed

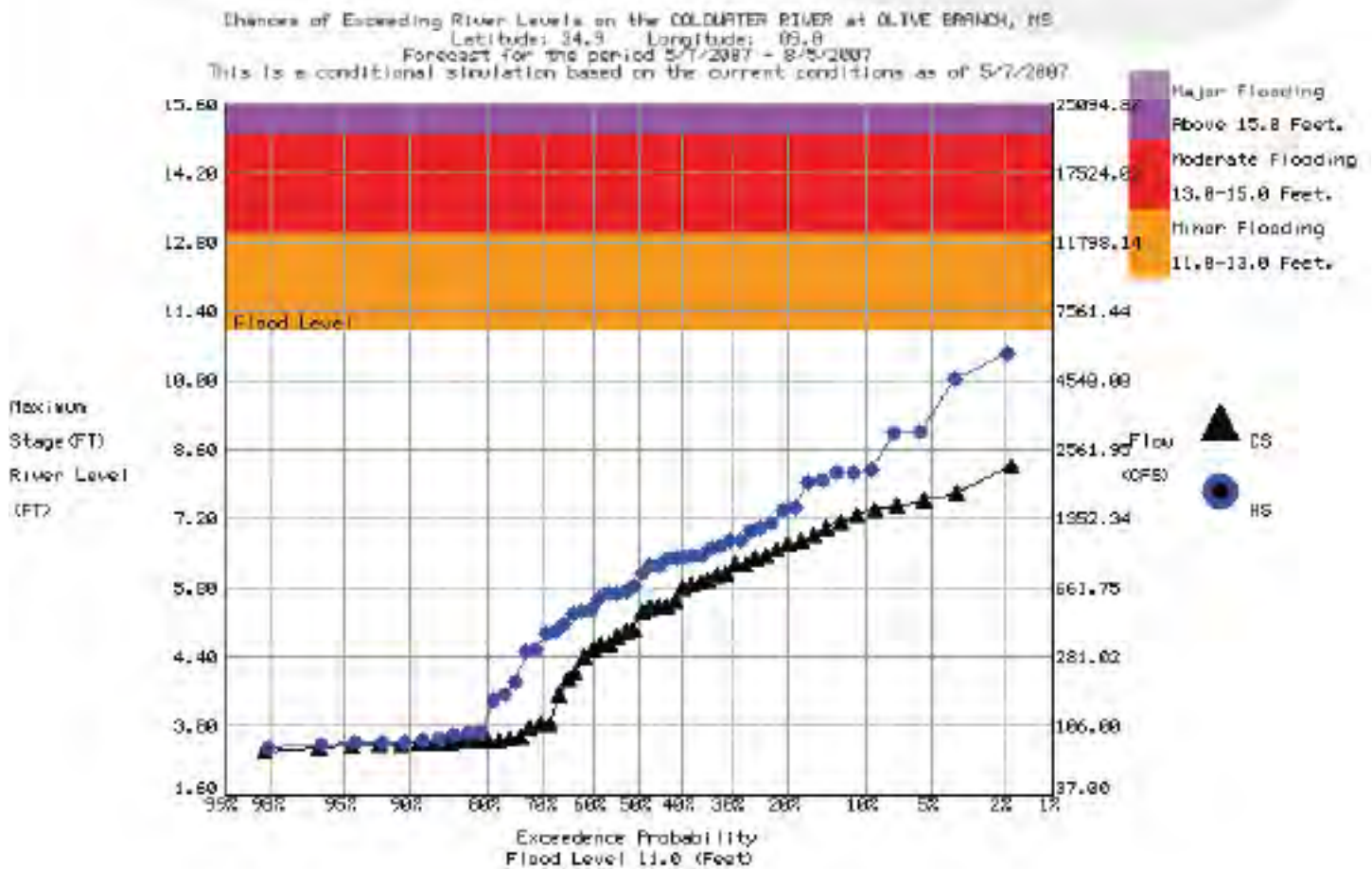

Figure 2. Sample long-term probabilistic product showing the likelihood of flooding in the next 90 days.

NWS is also working with the Federal Emergency Management Agency (FEMA) to encourage cities to develop these inundations maps during the modernization and update of FEMA Flood Insurance Rate Maps (FIRMs). This is only a small incremental increase in cost to develop inundation maps when flood studies are completed.

Distributed Hydrologic Model

Current RFC lumped hydrologic models run on a 6-hour timestep. Basin average rainfall for a 6-hour period is the primary input into these models. This modeling approach negates the utility and strengths of 4km x 4km precipitation

estimates from the WSR-88D. To make maximum use of the gridded rainfall on an hourly basis, LMRFC will implement the HLRDHM for selected basins. Using the HRAP grid system as a basis, soil moisture accounting will be performed each grid location using a modified SACSMA model. Kinematic techniques will be used to route water from one grid point to another until it reaches the basin outlet. This distributed model will help in forecasting since rainfall rarely falls uniformly in time and space across our modeled basins which may be as large as 800 square miles in size. The LMRFC will compare the output from the distributed model with the lumped parameter hydrologic model currently used

FLOODING AND WATER SUPPLY

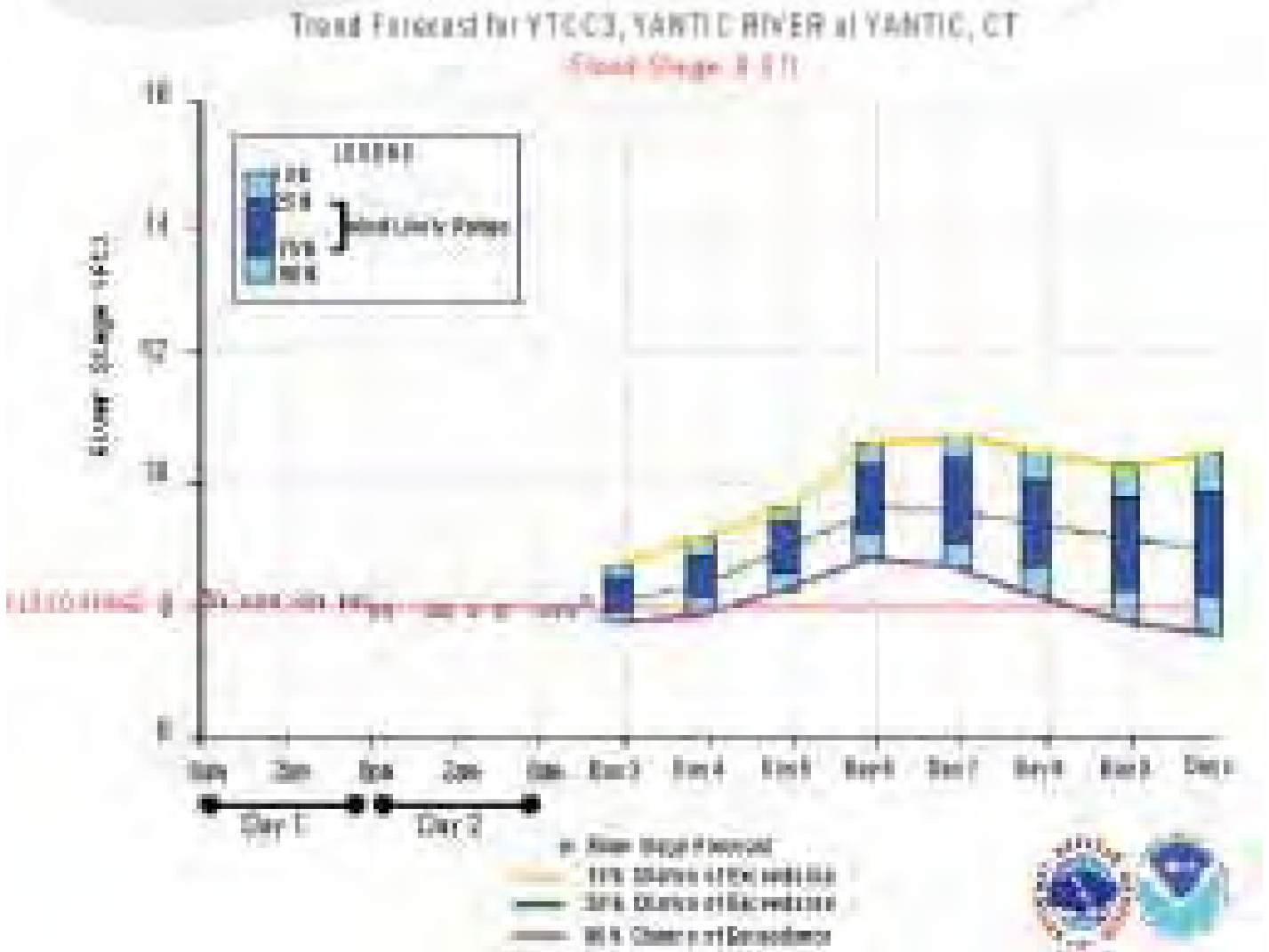

Figure 3. Sample of a short-term probabilistic river forecast.

in forecasting. Basin selection should be completed this summer and the model calibrated and implemented in late 2007 and 2008.

Expanded Outreach

These new tools and modeling techniques allow the NWS to expand the services provided to emergency managers and the public. These new tools are not perfect and the assumptions that are made in these techniques must be understood to be used effectively. The NWS will conduct extensive outreach and training with our customers to ensure they understand the limitations of these products. During

these visits, user feedback will be obtained and factored into future service improvements. Training and obtaining feedback is essential to ensuring that the products are used properly and that we meet customer needs as they evolve.

Conclusions

The NWS is implementing new and enhanced technologies to provide better forecast to the citizens of Mississippi. Coupling hydrodynamic oceans models with current riverine models and a 2-dimensional model of the Pascagoula will provide enhanced forecasts for that area. Flood inundation maps will provide emergency managers with an additional

Gages in the Lower Pascagoula



Figure 4. River gages and boundary conditions in the Pascagoula River basin.

FLOODING AND WATER SUPPLY



tool to make decisions on evacuations. The hourly SACSMA Site Specific model and the Distributed Hydrologic Model will provide forecasts in a finer temporal and spatial scale. The NWS will expand its outreach to brief the cooperators on these new tools.

FLOODING AND WATER SUPPLY

Supply and Demand: The Effects of Development on the Hydrology of Lake Victoria

Philip A. Songa and Sowed M. Sewagudde
Admiral House
Rose Wharf
78 East Street
Leeds, LS9 8BB
E-mail: philip.songa@arup.com

ABSTRACT

The water level of Lake Victoria has been falling since 2001 seriously affecting Uganda's economy. Since 2004 power generation has fallen due to reduced reservoir capacity. The 2004 Net Basin Supply (NBS) was only 37 Million Cubic Meters (MCM)/day or 49% of the long term NBS. Total outflow was 113 MCM/day in 2004, corresponding to a NBS exceeded 3 in 10 years. This unhinged the equilibrium of the system, highlighting the unsustainable use. At such outflows, the hydropower reservoir could be depleted in 5 to 6 years. If the next years are predominantly dry or wet this estimate would decrease or increase respectively. Returning to natural flow could lower energy production by up to 50% - 60% over the next two years. Planning and implementation of developments on Lake Victoria to date have not taken account of the multiple users of the lake, a factor that has contributed greatly to the crisis. Future developments should therefore consider all the competing uses by incorporating Integrated Water Resources Management (IWRM).

Keywords: Lake Victoria, IWRM, hydroelectric power, hydrology, Uganda, Agreed Curve, Net Basin Supply

Introduction

Lake Victoria is the largest fresh water lake in Africa and the second largest in the world, with a mean surface area of 68,870 km² and a maximum depth of 84 m. The 3,450 km of shoreline is shared by Kenya, Tanzania and Uganda. The lake basin covers about 181,000 km² (SIDA, 2003) and has an estimated population of 33 million (EAC Secretariat, 2004).

Lake Victoria and the River Nile have been the main source of hydropower for Uganda and the region since April 1954 when the Owen Falls Dam—now Nalubaale Dam—was commissioned. In recent years there has been a drastic drop in the water level of Lake Victoria. The drop has affected the socio-economic activities of Uganda and neighbouring states, notably through frequent and severe power shortages, a fall in fish supplies and unsafe docking of transport vessels. Various stakeholders have attributed the drop in lake level

to the commissioning of the additional Kiira dam in 2000 (The New Vision newspaper 14/10/2004; 11/10/2004; 19/10/2004).

This paper aims to examine this assertion using available hydrological data. Emphasis has been placed on reviewing data from the recent period 1997 - 2004 with the full record (1900 - 2004) used as reference.

The Hydrology of Lake Victoria

Lake Victoria receives about 2100 mm of rainfall annually over two main rainy seasons—the primary season is from March to May and the secondary season from September to December. The dry seasons are June to August (main) and January to February. During the mid-year dry season, evaporation from the lake exceeds rainfall by a factor of approximately 2.5. During the primary rainy season, rainfall is just greater than or equal to evaporation (WRMD, 2003). This

FLOODING AND WATER SUPPLY

highlights the critical role of evaporation on Lake Victoria. Rainfall on the lake surface accounts for 82% of the inflow of water to the lake. Evaporation from the lake surface accounts for 76% of the outflow and the River Nile outlet at Jinja in Uganda accounts for the rest.

Lake Victoria Release/ Regulation Policy

The current release rule in use, commonly referred to as the 'Agreed Curve', extrapolates the natural flow of the river, without the Owen Falls Dam. It is represented by a mathematical equation and is derived from the water level-discharge relationship established at what was then Ripon Falls:

$$Q = 132.923(h - 8.486)^{1.686}$$

where Q = discharge

h = stage (water level)

The rule restricts the amount of water flowing through the dams to that which would have flowed under natural conditions. It was established between the Protectorate Government of Uganda and the Governments of Egypt and Sudan after the Owen Falls Dam (now Nalubaale Dam) was completed in 1953.

Impacts of the Fall in Lake Level

Concern was raised in the latter half of 2004 as hydropower production in Uganda started to fall as a result of the lake level reducing. Since then, hydropower production has fallen by half. From an expected combined capacity (full) of 380 MW (Kiira Dam 200 MW; Nalubaale 180 MW), the total on the grid is 264 MW (The Monitor Newspaper, April 8 2007). Of this, Nalubaale & Kiira dams are producing 153 MW, thermal -generated power accounts for 101 MW while 10 MW is imported. The total current deficit (April 2007) therefore is 120 MW (The Monitor Newspaper, April 8 2007).

Other notable effects within the region include:

- Fish production has decreased as breeding grounds in shallow water are no longer accessible.
- It was difficult for larger vessels to dock as jetties were exposed.

- The Water Hyacinth is re-establishing on some parts of the lake shores with the roots taking hold in mud.
- Water and sewerage pipes were exposed leading to poorer quality raw water being pumped to treatment, associated cost of extending water supply pipes and risk of contamination from wastewater.

Currently the Directorate of Water Development (DWD) has restricted outflow to 750 m³/s (cf. Agreed Curve outflow of 530 m³/s) (C. Tindimugaya in 'Squeezing Victoria's Curves').

Study Methodology

The balance of rainfall, evaporation and outflow defines the lake's mass balance. The hydrological processes on the lake from 1900 - 2004 were reviewed and a comparison made with the year 2004 by examining the long-term lake levels, the Net Basin Supply (NBS), water releases through the dams and the net storage.

Examination of the Rate of Lake Level Drop

We investigated the severity of the current drop in water levels in relation to major historical lake level drop periods. The period 2000-2004 was compared with major drop periods from 1900 to date and ranked. Given Lake Victoria's size, a change exceeding $\pm 0.3\text{m}$ in successive years is characteristic of a dry or wet period. Selection of drop periods was based on successive years in which the drop exceeded 0.3 m. For a series $x_i (i = 1, 2, \dots, n)$ a drop occurs at any time $t (t = 1, 2, \dots, n)$. In the interval selected the time series should satisfy the following condition:

$$\text{If } x_{i-1} > x_i > x_{i+1} \quad (1)$$

Where $i (i = t + 1, 2, \dots, n)$ and is the t -value for which Equation 1 is satisfied again. Where $x_i - x_{i-1} \leq 0.10\text{m}$, the rise was ignored and the period was treated as a drop period.

Comparison of NBS and Nile Outflow/ Dam Releases

The following expression was adopted to represent the water balance of Lake Victoria.

$$\Delta S = \underbrace{\text{Rainfall} + \text{Land discharge} - \text{Evaporation} - \text{Release}}_{\Psi} \quad (2)$$

Where ΔS = the net storage

The quantity ψ in Equation 2 is referred to as the Net Basin Supply (NBS) and is defined as the 'inflow available for out flow'.

We computed the difference between the NBS and the dam releases /Nile outflow. A positive result (NBS > outflow/dam releases) implied that water drawn from the lake can be sustained by the supply whereas a negative one implied no replenishment of the resource. In the absence of complete data for the 3 components of the NBS for the period of interest, the NBS was calculated as a function of the depth and surface area.

Comparison of 'Rate of Storage Deficit' (RSD) in Major Drop Periods

The analysis used for the rate of drop was repeated using the same selection criteria for the drop periods but analysing the NBS instead of water levels. The RSD for the major water level drop periods was computed using Equation 3.

$$RSD = \frac{1}{n} \sum_{i=1}^n NBS \quad (3)$$

Where n = the number of years in drop period.

Analysis of the Releases at Nalubaale and Kiira Dams

The releases at Kiira and Nalubaale were expressed in terms of depth to determine their effect on the lake levels. The analysis was based on data beginning 1997/98 when first there were deviations from the Agreed Curve (releases were less than the Agreed Curve). At that time, the Directorate of Water Development (DWD) required further restriction of water releases to decrease the flow into Lake Kyoga downstream which had flooded following high El Nino rains.

Results and Discussions

Before 1960 the average Lake Victoria level was 1133.95 m above mean sea level (AMSL). The lake level rose by 2.4 m in a period of two and half years, a rise widely attributed to heavy rains between 1961 and 1964, and reflected in other lakes in the region (Plinston and Sene,

1994). The level remained at an average of 1134.9 m AMSL between 1960 - October 2004.

Figure 1 shows the long-term average lake level from 1900 to 2004 (1134.4 m AMSL). The lake level has shown a significant downward trend from 1960 with the level in 2004 being around the long-term average lake level from 1900 - 2003. By March 2005, the lake elevation was still in the natural fluctuating band of the lake but the increased rate at which the levels receded between 2003 and 2004 was of concern.

Table 1 shows the results from the examination of the rate of lake level drop and explains the most drastic drops in the level of Lake Victoria. It shows that 2002 - 2004 is not the worst elevation drop period for the lake. Three of the top five worst drop periods occurred before regulation of the lake i.e. 1917-1922, 1927-1929 and 1932-1935.

From the data, during the periods 1979-1982, 1964-1967, 1952-1955 and 1969-1977, lake rainfall and catchment discharges decreased considerably yet the losses due to evaporation and outflow at Jinja were on the increase, resulting in sharp declines in water level. The drop in levels for the period 1998-2000 however was caused by a decision to relieve Lake Victoria of excessive flooding caused by the El Niño rains. In drawing conclusions for 2000-2004, we should bear in mind that 2004 was not the end of the drop period but rather the end of the time series and it is clear that the drop period was still extending.

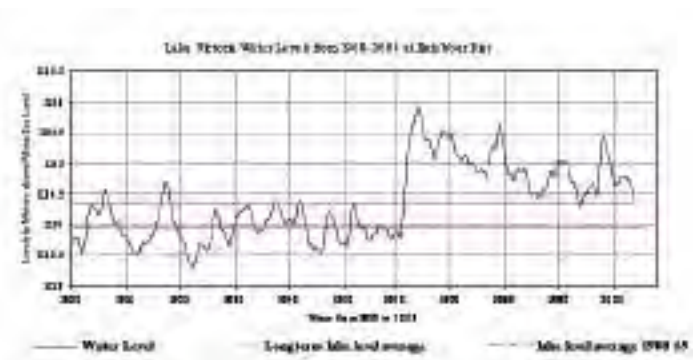

Figure 1. Long-Term Water level of Lake Victoria, 1900 - 2004.

FLOODING AND WATER SUPPLY

Table 1. Periods of extreme water level drop.

Period of drop			Water level (m AMSL)			Rate of drop (m/Yr)	Rank (Rate of Drop)
Start Year	End Year	Duration	Start	End	Drop (m)		
1932	1935	3	1134.27	1133.39	0.88	0.293	1
1979	1982	3	1135.58	1134.75	0.83	0.277	2
1964	1967	3	1135.92	1135.10	0.82	0.273	3
1917	1922	5	1134.61	1133.36	1.25	0.250	4
1927	1929	2	1134.15	1133.67	0.48	0.240	5
1948	1950	2	1134.12	1133.69	0.43	0.215	6
1942	1946	4	1134.40	1133.55	0.85	0.213	7
1952	1955	3	1134.33	1133.74	0.59	0.197	8
2002*	2004	2	1134.70	1134.32	0.38	0.190	9
1998	2004	6	1135.45	1134.32	1.13	0.188	10
1991	1994	3	1135.05	1134.51	0.54	0.180	11
1906	1912	6	1134.55	1133.54	1.01	0.168	12
1969	1977	8	1135.50	1134.33	1.17	0.146	13
1983	1986	3	1134.90	1134.54	0.36	0.120	14

* Does not satisfy set criterion not included because it is the period of concern.

Comparison of NBS, Nile Outflow/Dam Releases and RSD

The 2004 NBS was estimated as 37×10^6 m³/day, which is 49% of the long term NBS average of 76×10^6 m³/day. This corresponds to 27th percentile on the NBS frequency distribution. The Lake Victoria Water Management Study (2004) put the 2004 NBS at 22.9×10^6 m³/day or approximately 31% of the historical average NBS, corresponding to the lower 24th percentile on the NBS frequency distribution (Figure 2). Clearly from both results the lake basin experienced a hydrological drought. The discrepancy in the two results could be explained by the fact that the Water Management Study NBS was computed in September 2004 when the levels were lowest in the year, yet the lake experienced significant inflows from the late rains in November and December 2004.

Considering the low NBS, 2004's total release of $41,200 \times 10^6$ m³ (113×10^6 m³/day) severely destabilised

the system equilibrium. Figure 2 establishes that 2004's water release corresponds to a NBS of 3 in 10 years (put another way, the NBS is less than this value 70% of the time); contrast with the average NBS of 5 in 10 years. Furthermore in the last two years the water releases have been above the average NBS, which is clearly unsustainable.

From the RSD analysis, 2002-2004 is not the period with the highest water level drop rate, but it is the period with the highest RSD (Table 2). Of the top 10 ranked storage deficits, 7 occur after 1953 when the Nalubaale dam was completed. It is most likely that the existence and operation of the power station bears some responsibility for this value.

Analysis of the releases at Kiira and Nalubaale Dams

In 1997/98, operation of the power stations deviated from the Agreed Curve on the advice of DWD, releasing less water with intent to restrict flooding in Lake Kyoga downstream. Between May 1998 and May 2000, the releases

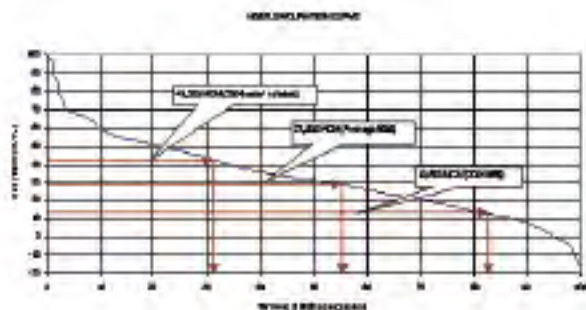

Figure 2. NBS duration curve.

were below what the natural flow would have been. As a result there was excess storage in Lake Victoria. Once the Kiira dam was commissioned (May 2000) the total releases exceeded what would have occurred under the Agreed Curve.

Between May 2000 and July 2001, the excess releases drew on accumulated storage which was used up by 15th July 2001 when the lake was back in balance (expected

level equal to actual level).

From 2000 to May 2004, the lake experienced a recess in levels, attributed to low inflows due to less than average rainfall. The trend was worsened by sustained high releases in excess of the expectation at the prevailing lake level. Excess releases continued to deplete the lake leading to a final levels of 1133.87 m on 3 November 2004 (expected Agreed Curve level would have been 1134.21 m).

It is clear that deviation from the Agreed Curve led to an additional lake drop of

0.34 m in about 3 years. This is supported by Kull (2006) who states that "...since the historical data used to develop the Agreed Curve included previous droughts, dam operations according to the Agreed Curve would not lead to unnatural extreme drops in lake levels". The excess releases increased the rate of drop in lake levels three-fold, with 2003 and 2004 accounting for 77% of the extra drop, and over 50% occurring during 2004 alone. At the end of 2004, the lake level was 1134.09 m rather than the expected 1134.47 m at the Jinja water level gauge.

Table 2. Comparison of releases vs. NBS in the major water level drop periods.

Period of drop			NBS	Release	Net Storage ΔS	$\Delta S/Yr$	Rank $\Delta S/Yr$	Rank Drop rate
Start Year	End Year	Duration						
2002*	2004	2	9,992	109,696	-99,704	-49,852	1	9
1964	1967	3	13,497	159,850	-146,354	-48,785	2	3
1983	1986	3	13,146	144,035	-130,888	-43,629	3	14
1991	1994	3	13,212	141,114	-127,902	-42,634	4	11
1979	1982	3	13,200	136,738	-123,538	-41,179	5	2
1969	1977	8	30,254	340,025	-309,771	-38,721	6	13
1998	2004	6	23,384	242,262	-218,878	-36,480	7	10
1927	1929	2	9,992	71,227	-61,235	-30,617	8	5
1932	1935	3	13,323	93,429	-80,106	-26,702	9	1
1942	1946	4	16,654	119,624	-102,970	-25,742	10	7
1948	1950	2	9,992	61,409	-51,417	-25,709	11	6
1952	1955	3	13,292	81,748	-68,456	-22,819	12	8
1906	1912	6	23,316	136,125	-112,809	-18,802	13	12
1917	1922	5	19,985	113,040	-93,055	-18,611	14	4

FLOODING AND WATER SUPPLY

Elsewhere, Georgakakos and Yao (2004) state that had the 2004 drought continued but the lake releases followed the Agreed Curve, draw down would have been reduced by more than half to an estimated 0.18 m. Corresponding energy generation would though decrease by 42% and would need to be supplemented. It is estimated that at the 2004 rate of release, the lake level would drop a further 2.5 m in 5 to 6 years before the minimum level for power generation (1131.40 m) were reached.

Potential Solutions

Thus current operation of the dams is clearly being done contrary to the regulation rule in order to meet electricity demand. It has been pointed out that the Agreed Curve does not reflect the most constructive way to manage the water resource because it does not encourage optimisation. A pragmatic solution could be to regulate the releases so that during periods of high inflow excess water is stored and utilised during periods of scarcity. This was proposed by Wardlaw et al (2005) who developed a procedure that would permit short-to-medium-term forecasts of potential reliable power generation to improve utilisation of high lake levels. This strategy could help maximise use of this water resource.

Historically the Agreed Curve has been followed to the extent that daily sluice discharges are adjusted to ensure that the total flow downstream of the Owen Falls power station met the requirements on a dekadal basis. If the level fluctuated rapidly, primarily due to the uneven timing of rainfall inputs, strict adherence to the Agreed Curve led to unpredictable requirements for flow adjustment in the very short term. With all the available water needed for energy generation and no surplus there was an undesirable fluctuation in energy supply.

To address this, Plinston (2002) proposed a rule to minimise the variation in flow caused by strict adherence to the Agreed Curve. He proposed an outflow that can be maintained for a whole year, based on the recognition of the equilibrium condition and the lake level at the start of the year.

$$\text{Outflow} = \text{Equilibrium outflow} + A * (\text{mean Agreed Curve outflow} - \text{Equilibrium outflow}) \quad (5)$$

where *Outflow* = the constant flow proposed for the year ahead

A = a parameter ranging from 0 - 1. If *A*=0, the outflow is constant at the equilibrium flow; if *A*=1, the outflow is set to the mean Agreed Curve flow conditions. Intermediate values give a balance of the two scenarios

Mean Agreed Curve outflow = the average flow over the year that would occur under Agreed Curve operation, conditional on the start of the year lake level, and given the expected (mean) NBS for the year ahead.

Equilibrium outflow depends only on the assumed mean of the future NBS

This rule is useful for mid-term management of the lake because it has an in-built tendency to maintain the lake level at its equilibrium level without losing the link with the Agreed Curve.

Conclusions

- 2002 - 2004 is not the worst drop rate period for the lake; the worst period occurred before regulation of the lake.
- However, 2002 - 2004 is the period with the highest Storage Deficit.
- Lake Victoria is being used unsustainably, with focus on power generation. Currently hydropower production has fallen below average capacity.
- If a similar level of releases to 2004 continues at average rainfall, the hydropower reservoir could be depleted in 5 - 6 years. If future years are extremely dry or extremely wet this limit will change accordingly.
- Planning and implementation of developments dependent on Lake Victoria must take account of the lake's multiple users and future hydrological implications.

References

WRMD (2003) A Hydro-climatic Study for Uganda. Directorate of Water Development, Ministry of Water, Lands and Environment, Uganda.

LVEMP (2002) Lake Victoria Water Quality and Limnology Study. Lake Victoria Environment Management Project.

Plinston, D. (2000) An Appropriate Short-Term Management Strategy For Lake Victoria To Provide Enhanced Stability In Hydropower Generation. SWRMD Technical report Nr: TR 01, 2000.

EAC Secretariat (2004) Proposal for Feed Back of the Vision and Strategy Framework for the Management and Development of Lake Victoria Basin to Stakeholders. East African Council.

Wardlaw, R.B., Sharif, M., & Kimaite, F. (2005) Real-time Hydropower Forecasting on the Victoria Nile. Proceedings of the Institution of Civil Engineers, Water Management 158 (WM2), 45-54.

Kull, D. (2006) Connections Between Recent Water Level Drops in Lake Victoria, Dam Operations and Drought. Nairobi, Kenya.

The New Vision newspaper, Monday, 11th October, 2004, Pg 25, The New Vision Printing and Publishing Co. Ltd. 2004.

The New Vision newspaper, 11th May, 2005, www.newvision.co.ug; accessed 23rd May 2006.

Plinston, D. & Sene. K.J (1994) A Review and Update of the Hydrology of Lake Victoria in East Africa. Hydrological Sciences Journal, 39, 1, February 1994.

The Monitor Newspaper, April 8 2007, "Thermal Energy Now Half of Total Electricity" by Angelo Izama.

BBC Radio 4: Factual, Monday 2 April 2007, "Squeezing Victoria's Curves", Presented by Aisha Yahya.

FLOODING AND WATER SUPPLY

The Geology of Ground Water in Mississippi Revised

David T. Dockery III
Mississippi Office of Geology
P.O. Box 20307
Jackson, MS 39289-1307
601-961-5544
E-mail: David_Dockery@deq.state.ms.us

ABSTRACT

A twelve-paged paper first published in the 32nd Annual Mississippi Water Resources Conference, April 23-24, 2002, Proceedings, summarizing the geology of ground water in Mississippi, is revised in a commentary on the importance of ground water to the state's historical and present-day development. The presence of shallow aquifers accessible by well digging was responsible for the location of many communities and for the transportation routes that tied these communities together. Today ground water is still one of the most important factors in community development. Ground water accounts for 80% of the state's water supply and more than 93% of the state's drinking water; only 3 of the state's 1,535 public water systems utilize surface water. Over 100,000 acres of farm-raised channel catfish ponds use ground water exclusively, and many farmers are dependent on ground-water supplies for irrigation. Mississippi's most valuable aquifers by rank include the (1) Mississippi River Valley Alluvium, (2) Miocene, (3) Wilcox, (4) Sparta, (5) Lower Cretaceous and Tuscaloosa, (6) Cockfield, and (7) Eutaw-McShan, (8) Coffee Sand, (9) Paleozoic (lumping the Devonian, Mississippian, and Pennsylvanian), (10) Ripley, (11) Citronelle-High Terraces, (12) Oligocene, and (13) Winona-Tallahatta aquifers.

Keywords: Ground water, aquifer, geology, Mississippi

CLOSING PLENARY SESSION



Ms. Joy Foy

Director, Asset Development Division
Mississippi Development Authority

Dr. LaDon Swann

Director
Mississippi - Alabama Sea Grant Consortium